

# LYNX LCD Wall Modules CLCMTR7x, CLCMTR7x-H

## Specification Data



### GENERAL

The CLCMTR7x series are 2-wire, non-polarity sensitive, Sylk Bus communicating wall modules for use with LYNX controllers.

Table 1. Models

features	CLCMTR70 + CLCMTR70-H	CLCMTR71 + CLCMTR71-H	CLCMTR75 + CLCMTR75-H
scheduling	--	--	X
parameter memory	1 KB	1 KB	1 KB
up to four wall modules on Sylk	X*	X	X
enumerated values	--	X	X
setpoint limits as NVs – linking possible	--	X	X
system and fan command as NVs	--	X	X
password protection	--	X	X
firmware version / model displayed	--	X	X
0.5 and 5-value increments	--	X	X
"-" and "/" characters in parameter names	--	X	X
*Support for up to four CLCMTR71 /-H and/or CLCMTR75 /-H per controller, and if a CLCMTR70 /-H is present, a max. of three LYNX wall modules (any combination) allowed.			

All models have a space-temperature sensor and an LCD panel with three softkeys and two Up/Down adjustment keys. The CLCMTR7x-H models include an onboard humidity sensor.

**NOTE:** Refer to the CentraLine LYNX TOOL – User Guide (EN2Z-0960GE51) for information on customizing the wall module configuration (e.g., modifying the default home screens or creating your own application).

### FEATURES

- User-access to LYNX controller parameters.
- Customized parameter-access (using the Comfort Point Open Studio tool).
- Programmable for: Home screen options, tenant-access, contractor-access, access to controller parameters, setpoint, override, fan, and other parameters.
- Eight pre-programmed configurations (e.g., VAV with balancing) in the wall module configuration tool.
- Ability to access and adjust most parameters in the LYNX controller (except Scheduling).
- Ability to balance the VAV system from wall module.
- Home screen can display up to 3 of any of following parameters: Temp. Setpoint, Room Temp., Room Humidity, Outdoor Humidity, Outdoor Temp., and Time – or one of virtually any of the parameters in LYNX.
- BACnet / LONWORKS Bus jack.
- Simple, 2-wire terminal connection to LYNX controller and optional 2-wire terminal connection to the BACnet / LONWORKS Bus. All connections are polarity-insensitive.
- Retention of user configuration, including setpoints, after a power outage.
- Access (CLCMTR75 and /-H) to LYNX Scheduling.
- IP30 housing.

### SPECIFICATIONS

<b>Construction:</b>	Two-piece construction, cover and internally wired sub-base. Field wiring, 18 to 24 AWG (0.82 to 0.20 mm <sup>2</sup> ), connects to a terminal block in the sub-base
<b>Mounting options:</b>	Mountable on standard 2x4 inch or 60 mm Ø junction boxes. Mountable up to 61 m from LYNX controller. Twisted pair wiring recommended for distances > 30.5 m.
<b>Dimensions</b>	See Fig. 2.
<b>Operating temperature:</b>	-1 ... +43 °C
<b>Shipping temp.:</b>	-40 ... +65.5 °C
<b>Relative humidity:</b>	5 ... 95%, non-condensing
<b>Temperature setpoint range:</b>	Default range is 10 ... 35 °C; configurable for other ranges
<b>Temperature sensor accuracy:</b>	± 0.2 °C at 25 °C
<b>Humidity sensor accuracy:</b>	± 5% RH from 20 ... 80% RH
<b>Power supply:</b>	18 Vdc power is supplied to the wall module from the 2-wire, S-BUS connection to the LYNX controller
<b>Approvals:</b>	CE; UL94-HB plastic enclosures; FCC part 15, Class B

## Wiring

The LYNX wall module is shipped with its mounting plate (sub-base) separate from the module. All terminal connections can be made to the back of the module. There are no field adjustable/replaceable components inside.

Attach the wires from the LYNX controller and the bus to the appropriate wall module terminals, as indicated in Fig. 1.

## CAUTION

**Improper Electrical Contact Hazard.**  
**Screw-type terminal blocks are designed to accept no more than one 18 AWG (0.82 mm<sup>2</sup>) conductor**  
 Connect multiple wires that are 18 AWG (0.82 mm<sup>2</sup>) with a wire nut. Include a pigtail with this wire group, and attach the pigtail to the individual terminal block.

## Wiring Wall Modules

Wire the terminal block shown in Fig. 1 as follows:

1. For single wires, strip 5 mm (3/16 in.); for multiple wires going into one terminal, strip 13 mm (1/2 in.) insulation from the conductor.
2. If two or more wires (20 to 24 AWG only) are being inserted into one terminal, twist the wires together before inserting.
3. Insert the wire in the required terminal location and tighten the screw to complete the termination.
4. Review and verify the terminal connection wiring illustrated in Fig. 1.

**NOTE:** The recommended wire size for the BACnet Bus, LonWorks Bus, and S-BUS is Level IV, 22 AWG (0.34 mm<sup>2</sup>) plenum or non-plenum rated, unshielded, twisted pair, solid conductor wire.

## Terminal Wiring Location

Fig. 1 shows the location of the terminal block and other features on the CLCMTR7x and CLCMTR7x-H wall modules.

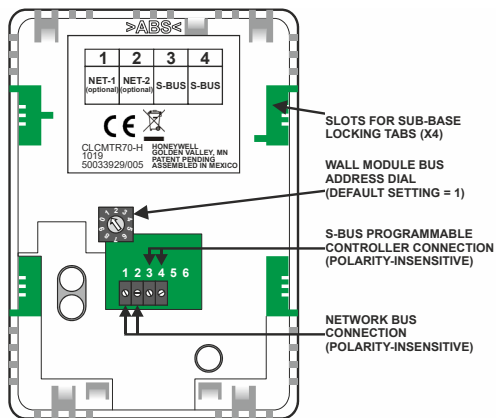

Fig. 1. LYNX wall module components (rear view)

**NOTE 1:** 18 Vdc power for the LYNX wall modules is supplied from the LYNX controller.

**NOTE 2:** Each of the 2-wire connections for the BACnet Bus, LonWorks Bus, and S-BUS are polarity insensitive.

## Module Dimensions

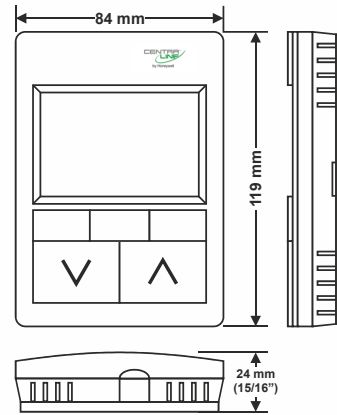

Fig. 2. LYNX wall module dimensions

## Setting the Wall Module Bus Address Dial

Ensure that the wall module bus address dial is set to the factory default of one (1). Use a thin blade screwdriver to turn the dial arrow. The address on the wall module must match the address in the tool. The address in the tool is also set to the factory default of one (1).

## Attaching the Wall Module to the Sub-Base

When all wiring is complete, press the LYNX wall module straight down onto the sub-base until it snaps into place.

## POWER UP

After the wall module is properly wired to the controller, it will power up. Upon initial power up, the wall module's LCD panel displays the phrase "PLEASE LOAD" (see Fig. 4). This phrase alternates with any onboard sensor display, such as temperature, humidity, etc.

**NOTE:** Refer to the CentralLine LYNX TOOL – User Guide (EN2Z-0960GE51) for information on configuring and loading the desired user interface and parameters into the wall module.

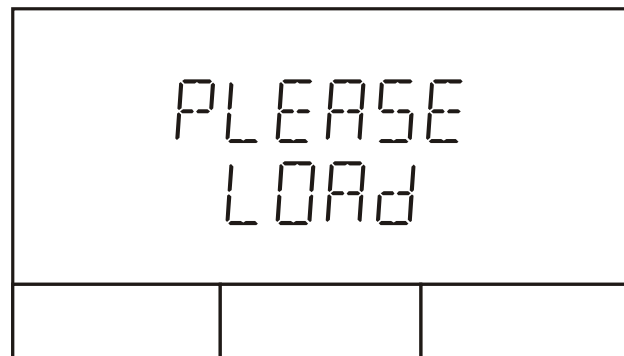

Fig. 3. Wall module LCD display at initial power-up

## Communications

The LYNX wall modules use a sensor bus (S-BUS) for communications with the LYNX controller.

For BACnet communication, the building's BACnet wires connect to the two terminals (NET-1 and NET-2). See Fig. 1. A BACnet bus port is accessible at the bottom of the wall module by removing the jack plug.

The BACnet Bus, LONWORKS Bus, and S-BUS (see Fig. 1) are insensitive to polarity, minimizing installation errors due to mis-wiring. The recommended wire size for the BACnet Bus, LONWORKS Bus, and S-BUS is Level IV, 22 AWG (0.33 sq. mm) plenum or non-plenum rated, unshielded, twisted pair, solid conductor wire.

## LCD Display

The LCD display may be customized for tenant and contractor users. The following are just a few samples of the many different screens configurable for the LYNX wall modules.

**NOTE 1:** Home screens can display one to three of any of the following parameters: Temperature Setpoint, Room Temperature, Room Humidity, Outdoor Humidity, Outdoor Temperature, and Time, or one of virtually any parameter in the controller.

**NOTE 2:** Refer to the CentraLine LYNX TOOL – User Guide (EN2Z-0960GE51) for information on customizing the wall module configuration (e.g., modifying the default home screens or creating your own application).

### Sample Tenant LCD Displays

The Fan and Occupied settings are optional for Home screen setup. If there are no parameters configured for Tenant access, the "View More" softkey does not display on the Tenant Home screen.

The following are just a few samples of the many different screens that are configurable for the LYNX wall modules.

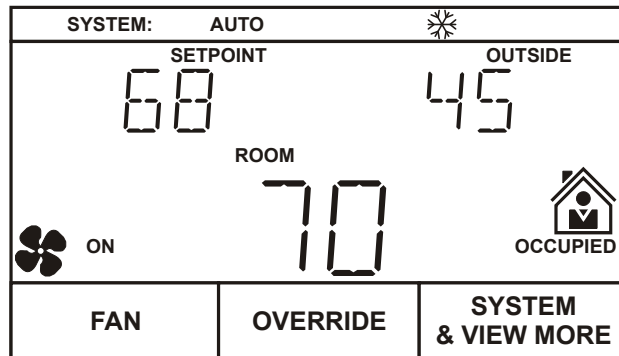

**Fig. 4. Sample Tenant Home screen with System Status, Setpoint, Outside Temperature, and Room Temperature (predominant)**

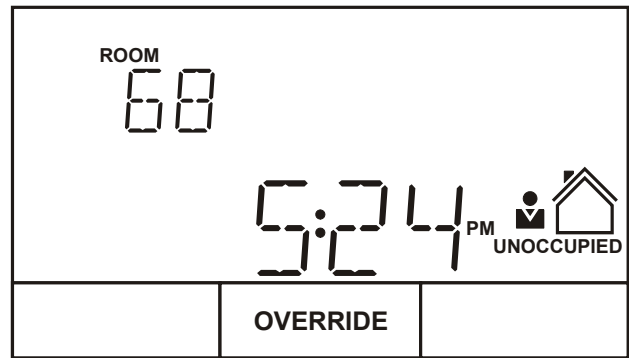

**Fig. 5. Sample Tenant Home screen with Room Temperature and Time (predominant)**

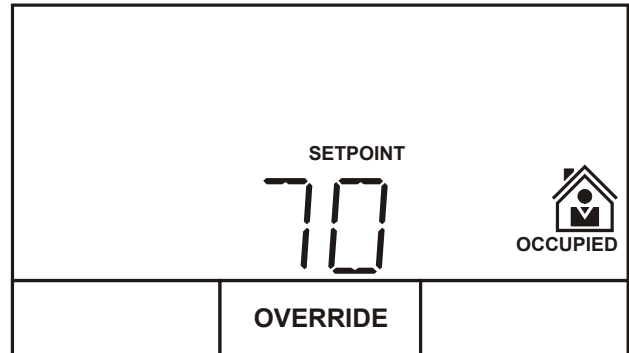

**Fig. 6. Sample Tenant Home screen with Setpoint display, only**

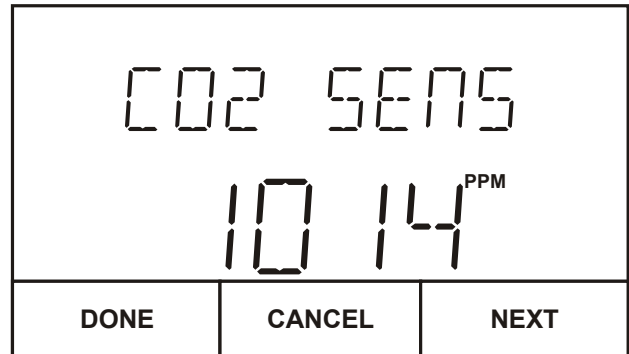

**Fig. 7. Sample Tenant "View More" display showing CO2 sensor value from controller**

**NOTE:** Any configured parameter may be displayed.

### Sample Contractor LCD Displays

The Contractor mode allows advanced options using the softkeys. Contractor mode also allows for customizing the Tenant view, including setting the tenant's Home screen and "View More" access.

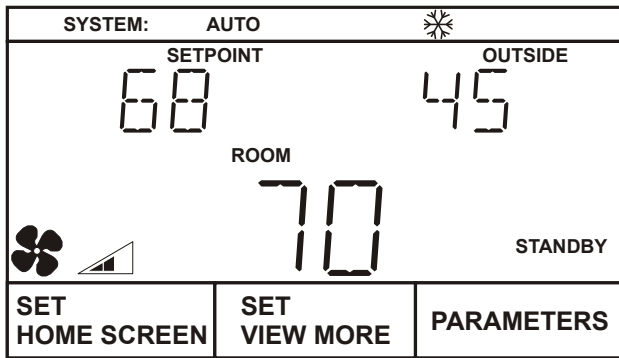

Fig. 8. Sample Contractor Home screen display with System Status, Setpoint, Outside Temperature, and Room Temperature (predominant)

**CONTRACTOR HOME SCREEN SOFTKEYS**

The three softkeys on the Contractor Home screen (see Fig. 8) provide the following:

SET HOME SCREEN: Allows the contractor to choose among multiple Home screen options for the tenant.

SET VIEW MORE: Allows the contractor to give additional parameter-access (view only or adjustable) to the tenant.

PARAMETERS: Allows the contractor to monitor and/or adjust parameters in the LYNX controller.

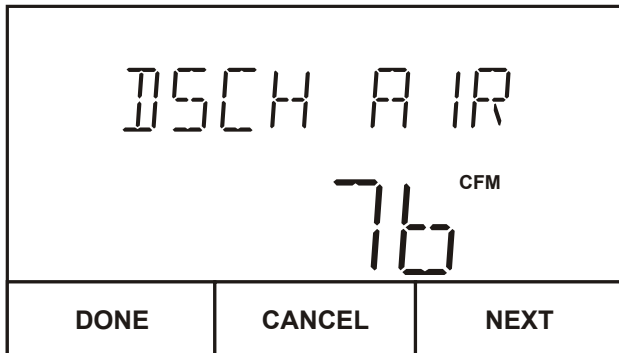

Fig. 9. Sample Contractor parameter display showing user-created discharge air parameter value

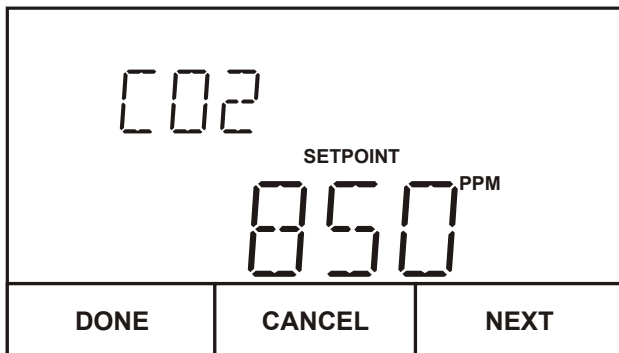

Fig. 10. Sample Contractor parameter display showing sensor setpoint value (CO2 sensor from controller)

**NOTE:** Any configured parameter may be displayed.

## ADVANCED WALL MODULE

### 1. Description:

The advanced wall module shall be designed specifically for the flexible room-level operation of HVAC systems. It shall be designed specifically for operation by end users and service personnel.

### 2. Minimum Requirements:

- a. The advanced wall module shall have an LCD display with backlight.
- b. The LCD backlight shall be automatically activated upon pressing any of its buttons, and shall be automatically deactivated after no key press has happened for a pre-defined time.
- c. The advanced wall module shall have the following buttons:
  - One large button for incrementing values or parameters
  - One large button for decrementing values or parameters
  - Three soft-key buttons, whose functionality shall be defined by a symbol on the display area above each soft-key.
- d. The advanced wall module shall be suitable for direct mounting onto standard wall outlet boxes, without the need for any additional mechanical interfaces or adapters.
- e. In order to save wiring, to avoid mis-wiring, and to avoid the need for a power supply at the wall module, the advanced wall module shall make use of a two-wire, polarity-insensitive bus connection providing both power and communications with a room, unitary or universal controller.
- f. The minimum distance to the controller shall be 60 m.
- g. In order to allow for universal usability and understandability, the advanced wall module shall provide symbols as per international standards (e.g., ISO 7000) on its LDC display.
- h. The advanced wall module shall have a customizable home screen allowing for the following display options:
  - Shall be capable of simultaneously showing up to 3 parameter values on a single display
  - Shall be capable of showing and commanding the occupied / stand-by / un-occupied status
  - Shall be capable of showing and commanding the system status.
  - Shall be capable of showing and commanding the fan status, with the options OFF, AUTO, Stage-1, Stage-2, and Stage-3.
  - Shall be able capable of showing and commanding the fan status of 0...10 V controlled fans to at least five (5) positions: OFF, AUTO, 30%, 60%, and 100%
  - Shall be capable of simultaneously showing up to three of the following parameters: Room temperature, setpoint, outside temperature, room humidity, outside humidity, time of day.
  - Shall be capable of showing any single parameter in the controller, with a user-defined, 8-letter name.
- i. The advanced wall module shall allow for online selection from, at minimum, ten (10) different home screens.
  - j. The advanced wall module shall offer a communication jack for remote access to the controller network.
  - k. The advanced wall module shall have an onboard temperature sensor, with a minimum sensor accuracy of:  $\pm 0.2^{\circ}\text{C}$  at  $25^{\circ}\text{C}$ .
  - l. The advanced wall module shall have an onboard humidity sensor.
  - m. The advanced wall module shall offer read and write access to all parameters necessary to balance a VAV system.
  - n. The advanced wall module shall offer the ability to restrict access to parameter information with keypad-enabled lock-out.
  - o. The advanced wall module shall retain user configuration, including setpoints, after power outage.
  - p. The advanced wall module shall offer the ability to access and adjust user-chosen controller parameters.
  - q. The advanced wall module shall offer the ability for the end user to adjust override time period within the limits set by the wall module configuration.
  - r. The advanced wall module shall comply with the following minimum Environmental ratings:
    - Operating temperature ambient rating:  $-1 \dots +43^{\circ}\text{C}$ .
    - Storage temperature ambient rating:  $-40 \dots +65.5^{\circ}\text{C}$ .
    - Relative Humidity: 5% to 95% non-condensing.
  - s. The advanced wall module shall comply with the following standards:
    - Housing shall be UL plenum-rated UL94-HB plastic enclosure
    - FCC Part 15, Class B

---

LYNX™ is a trademark of Honeywell International Inc.  
Sylk™ is a trademark of Honeywell International Inc.

Manufactured for and on behalf of the Connected Building Division of Honeywell Products and Solutions SARL, Z.A. La Pièce, 16, 1180 Rolle, Switzerland by its Authorized Representative:

Centraline  
Honeywell GmbH  
Böblinger Strasse 17  
71101 Schönaich, Germany  
Phone +49 (0) 7031 637 845  
Fax +49 (0) 7031 637 740  
[info@centraline.com](mailto:info@centraline.com)  
[www.centraline.com](http://www.centraline.com)

Subject to change without notice  
EN0Z-0955GE51 R0119

