

EAGLE WEB INTERFACE

User Guide



EAGLE Web Interface

USER GUIDE

Software License Advisory

This document supports software that is proprietary to Honeywell GmbH, Honeywell Control Systems Ltd. and/or to third party software vendors. Before software delivery, the end user must execute a software license agreement that governs software use. Software license agreement provisions include limiting use of the software to equipment furnished, limiting copying, preserving confidentiality, and prohibiting transfer to a third party. Disclosure, use, or reproduction beyond that permitted in the license agreement is prohibited.

Trademark Information

CentraLine and `close to you` are trademarks of Honeywell Inc.

Windows 7, 8, and 10 are registered trademarks of Microsoft Corp.

BACnet is a registered trademark of American Society of Heating, Refrigerating and Air-Conditioning Engineers (ASHRAE).

Echelon, LON, LONMARK, LONWORKS, LonBuilder, NodeBuilder, LonManager, LonTalk, LonUsers, LonPoint, Neuron, 3120, 3150, the Echelon logo, the LonMark logo, and the LonUsers logo are trademarks of Echelon Corporation registered in the United States and other countries. LonLink, LonResponse, LonSupport, and LonMaker are trademarks of Echelon Corporation.

CONTENTS

SOFTWARE AND FIRMWARE VERSIONS	9
3RD-PARTY SOFTWARE LICENSES	9
SYSTEM REQUIREMENTS	9
NETWORK SECURITY	9
SYSTEM OVERVIEW	11
General.....	11
Versions and Firmware.....	12
Browser Access / Operator Interface.....	12
Network	13
Operation and Application Software	15
Backup/Restore.....	17
Diagnostics.....	18
EAGLE WEB INTERFACE	19
USER ADMINISTRATION	19
DATAPPOINTS	23
Physical Datapoints	23
Value Datapoints	23
Reference Datapoints.....	24
Mapped Datapoints	25
Datapoint Properties.....	25
Properties Descriptions.....	26
Ackn. (Acknowledged Transitions)	27
Active / Inactive Text.....	27
Alarm Delay	27
Alarm Text	27
Alarm Type	28
Alarm Value	28
Alarm Value Enable	28
Auto	29
BACnet Instance.....	29
BACnet Object (Type).....	30
BACnet Object ID	31
Change of State Count	31
Change of Value Increment.....	31
Bit Mask.....	32
Bit String(s).....	32
Characteristic.....	32
COV Period	32
Current Value	33
Datapoint Name.....	33
Deadband	33
Description.....	34
Descriptor	34
Direct/Reverse	35
Direction	35
Engineering Unit	35
EOV / EOY Optimization.....	35
Event	36
Event Enrollment	36
Event State	36
Fault.....	37
Feedback Value.....	38
FIO Mapping.....	38
Fixed Prio	38
High Limit Enable	39

In Alarm	39
Increment	40
Initial Value	41
Input NV	41
IO Configuration	41
Is Alarm Condition	41
Is Fault Condition	42
Last Transition	42
LON Point	42
Low Limit Enable	43
Manual	43
Manual Life Safety	43
Mapping	44
Minimum Present Value	44
Maximum Present Value	44
Notification Class	44
Notify Type	45
NV Name	45
NV Type	45
Out Of Service	45
Output NV	46
Period	46
Priority Level	47
Polarity	48
Property	48
Read Access Level	48
Reference	49
Reliability	50
Relinquish Default	50
Relinquish Priority	50
Remote Status Flags	51
Reporting	51
Reset to	51
Change of State Count	52
Resolution	52
Runtime (Active Time)	52
Safety Position	52
Safety Value	53
Scaling Factor	54
Sensor Offset	54
Time to Close	54
Time to Open	54
State Text	55
States	55
#States	55
Time Delay	55
Time of Last Reset	55
Time of State Count Reset	56
Transition Events	56
Type	56
Use as Setpoint	56
With Switches / 3 Position Output	57
Write Access Level	57
Datapoint Properties Overview	57
Analog Input	58
Analog Output	60
Analog Value	62
Binary Input	64
Binary Output	66
Binary Value	68
Multi-State Input	70
Multi-State Output	72
Multi-State Value	74
Pulse Converter	76
Reference Input	78
Reference Output	78
I/O Initialization	79
Input Datapoints (AI, BI)	79
Output Datapoints (AO, BO)	80

Reference Inputs	80
Summary	81
Setting Datapoints into Manual Mode (Manual Override).....	81
Setting and Detecting Manual Overrides of Datapoints	82
Status Flag Indications	83
Input Point Status Flags.....	83
Output Point Status Flags.....	83
Alarm and Event Priority Classification.....	84
ALARM HANDLING	85
Alarm Behavior of Datapoints.....	85
Alarm Settings and Alarm Display for Analog Inputs and Outputs.....	88
Analog Input	89
Analog Output.....	90
Analog Value	90
Binary Input	91
Binary Output.....	91
Binary Value	92
Multi-state Input.....	92
Multi-state Output	93
Multi-state Value.....	93
Pulse Converter.....	94
Notification Class Manager.....	95
TIME PROGRAMS	97
Schedules and Calendars	97
TRENDING	99
PLANTS	99
CONTROL LOOPS	99
Parameters.....	100
Cycle Time Category.....	100
SYSTEM SETTINGS	100
Diagnostics.....	100
EMAIL ALARMING	101
EVENT ENROLLMENTS	101
Event Enrollment Objects / Algorithmic Change Reporting	101
OPERATING THE EAGLE WEB INTERFACE.....	103
Start Eagle Web Interface	103
Login via HTTPS	104
Main Screen Description and Basic Functions	114
Main Screen Description.....	114
Basic Functions	118
User Administration	122
Invoke User Administration.....	122
Create Access Rights List.....	123
Create User	124
Edit User.....	127
Delete User.....	129
Display Project Information.....	129
Display Controller Information	130
Device Name	135
Display Plant Information.....	135
Fast Access Lists	137
Create Fast Access List.....	137
View / Modify Fast Access List	147
Delete Fast Access List	150
Schedules.....	151
View Existing Schedules.....	151
Create Schedule.....	152
Calendars	165

- View Calendars 165
- Create Calendar 166
- Copy Calendar 169
- Edit Calendar 170
- Delete Calendar 173
- Show Calendar References..... 173
- Datapoints 174
 - View Datapoint List 174
 - View / Edit Datapoint Details 175
 - General Procedure 176
 - View General Properties..... 177
 - View / Edit Alarming 178
 - View / Edit Values 181
 - View / Edit Command Priorities 186
 - View / Edit Event Enrollment Alarming 187
- System Settings 198
 - View/Change Clock Settings 198
 - View/Change Cycle Time Categories 200
 - View/Change Communication Settings 201
 - View LON Diagnostic Data 204
 - View BACnet Diagnostic Data 206
 - View Panel Bus Diagnostic Data 207
 - View BACnet Diagnostic Data 208
 - BACnet Statistics..... 209
 - View Modbus Data 210
 - View / Change M-Bus Data 211
 - Web Server Certificates..... 213
- Trend 214
- Alarms 224
 - View Alarm Details 226
- Control Loops..... 229
 - View Control Loop Information 229
 - Parameters 230
 - Change Parameter 233
- Loop Objects 235
 - View/Edit Loop Object 235
- Enable Event Enrollment Alarming..... 241
 - Enable Event Enrollment Alarming for Plant..... 241
 - Enable Event Enrollment Alarming for Controller System Status 244
 - Enable Event Enrollment Alarming for Controller Email Alarming 246
- Email Alarming 248

- XWADMIN.INI FILE ENTRIES 254**

- AUTOMATIC SAVING OF ONLINE CHANGES..... 255**
 - Eagle Controller and Communication Failures 255

- CONTROLLER OVERLOAD INDICATORS..... 256**

- CONTROLLER BOOT AND WATCHDOG BEHAVIOR..... 257**
 - Controller Restart 257

- TROUBLESHOOTING 258**

- INDEX 259**

SOFTWARE AND FIRMWARE VERSIONS

This user guide is valid for the following software versions:

- Eagle 4-02-00-xx
- CARE 10.08.00

3RD-PARTY SOFTWARE LICENSES

This product contains software provided by third parties. See also Excel Web II Controller – Third-Party Software Licenses (Product Literature No.: EN2Z-0991GE51).

SYSTEM REQUIREMENTS

To operate the Excel Web II HTML Interface via touch panel PCs or any other standard PC platform, the following requirements must be fulfilled:

Web browsers

PC

- Internet Explorer 9.0 or higher
- Firefox 15.0 or higher
- Google Chrome

Android

- Standard Web Browser
- Firefox 15.0 or higher
- Safari
- Google Chrome

IOS

- Safari

NETWORK SECURITY

When operating Excel Web II in IP networks, either private (e.g., VPN) networks must be used or protection against the open Internet (e.g., with external firewalls) must be ensured.

Honeywell hereby expressly states that the Excel Web II controller is not inherently protected against cyber attacks from the Internet and that it is therefore intended solely for use in private, protected networks.

Unprotected Internet connections can expose the Excel Web II controller to cyber attacks from third parties who can then damage it and connected facility components or cause them to malfunction, or who can misuse it for illegal purposes for which the operator may then be held liable.

When directly connected to the Internet, the Excel Web II controller automatically becomes a potential target for cyber attacks. Corresponding protective measures are therefore essential if safe and reliable operation is to be ensured.

If it is not necessary for the Excel Web II controller to be accessible from the Internet, it should be isolated from the Internet via appropriate IP port settings.

If it is necessary for the Excel Web II controller to be accessible from the Internet (e.g., in order to perform remote maintenance), the use of a coded VPN connection is indispensable. Suitable VPN routers are available from numerous third-party manufacturers in a wide variety of designs, for operation at 230 V or 24 V.

For details, see also Excel Web II Networking Whitepaper (Product Literature No.: EN2Z-0992GE51).

SYSTEM OVERVIEW

General

The Eagle® is a BACnet/IP-based and BACnet MS/TP-based, freely programmable building automation controller.

As a native BACnet® building controller, Eagle® integrates into any 3rd-party BACnet® system and can integrate 3rd party BACnet devices and controllers. Furthermore, Eagle® is a full LONWORKS® controller. This gives the benefit of enabling you the use of Honeywell's complete LONWORKS® product portfolio and 3rd-party LON products.

The Eagle® can host a huge variety of building management applications, be it traditional heating, ventilation, and air conditioning (HVAC) applications, energy management functions, including optimum start/stop, night purge, and maximum load demand, supervisory functions for lighting, sunblind, heat and energy metering and many other applications.

By virtue of its "peer-to-peer" concept plus its embedded web server and embedded Email alarming, Eagle® is not dependent upon the availability of super ordinate BACnet clients (front-ends) or application network controllers.

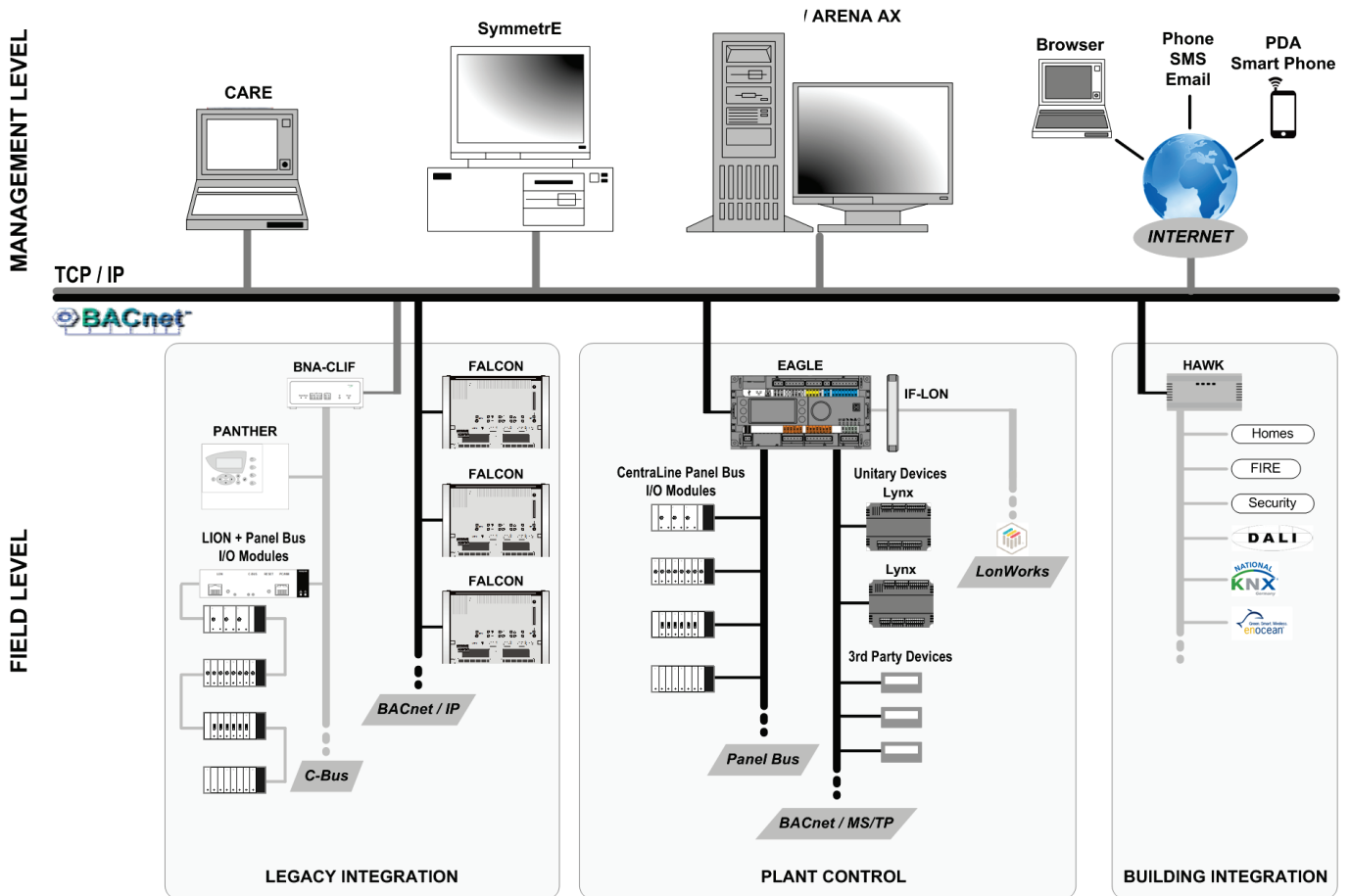

Versions and Firmware

Eagle Versions	<p>The Eagle controllers are available with zero/14/26 onboard IOs, with and without HMI.</p> <p>For more details, please refer to Product Data EN0Z-970GE51.</p>
Eagle Firmware	<p>Includes the following parts:</p> <ul style="list-style-type: none"> • Linux operating system • XW System • XW Main (including firmware itself, BACnet driver and HTML pages (H-MM-LL are version numbers)
Updating Firmware	<p>If, at some later point in time, i.e. after the release of a new version of the firmware, the user wishes to download the new firmware into the Eagle, this can be done either via USB or Ethernet, using CARE.</p>

Browser Access / Operator Interface

Operator Interface The Eagle® is operated via a standard web browser (Eagle Web Interface). By default, an integrated web server provides all operation pages for a full browser-based operation. Through the consequent use of software standards, any PC platform can be used as an operator interface (client). In addition to laptops and desktop PCs, panel PCs can also be used for direct flush mounting into panel doors. Other than the operating system and Internet Explorer® or Firefox®, no software needs to be installed on the client PCs.

Alternatively – or in addition – Eagle can be operated with the CL-Touch operator interface, which is a 5.7” touch-screen device (order number “CLMMI00N31”). For more details please refer to the CL-Touch product data sheet, form no. EN0Z-0929GE51 or/and to the CL Touch User Guide, form no. EN2Z-0929GE51.

Access Modes to Eagle Controller

Any Eagle controller on the network can be accessed via the browser-based Eagle Web Interface, both locally and remotely. The Eagle Web Interface can reside on any PC platform client such as:

- Desktop PC
- Notebook, Laptop

The controller can be accessed in one of the following ways:

- **LAN** (remote access)

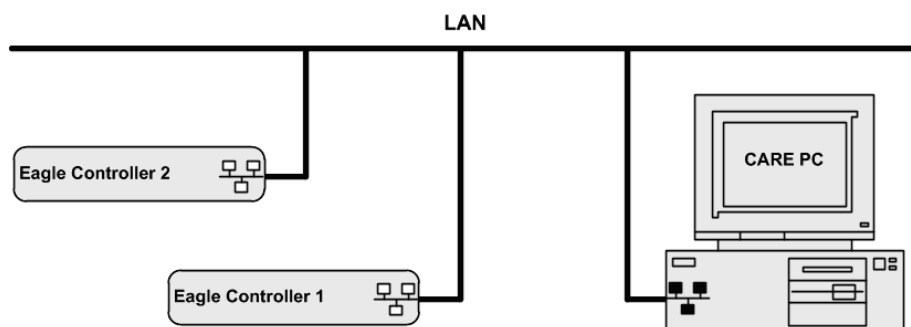

Fig. 1. Access to Eagle controller via LAN

Permanent (or DHCP) IP address, allocated by I.T. department

The Eagle controller can be accessed remotely via LAN by allocating a valid and permanent (or DHCP) IP address to the controller, which is reachable within the LAN.

Procedure:

See Establish Remote LAN Connection section in CARE User Guide EN2Z-0970GE51.

Standard Ethernet Interface of your PC

Change the (factory-set) configuration of the integrated Ethernet card so as to match the Eagle IP address and IP subnet.

NOTE:

In order to (subsequently) operate on your standard Ethernet network (again), you will have to change the configuration back to the previous settings.

Dedicated Ethernet Interface of your PC

If the laptop or PC with which you wish to access the Eagle via Ethernet/IP is not already equipped with an integrated Ethernet Card, or if you want to leave the IP settings of the integrated network card unchanged, you can buy and install (into your laptop or PC) an external Ethernet network card.

- **USB (local access)**

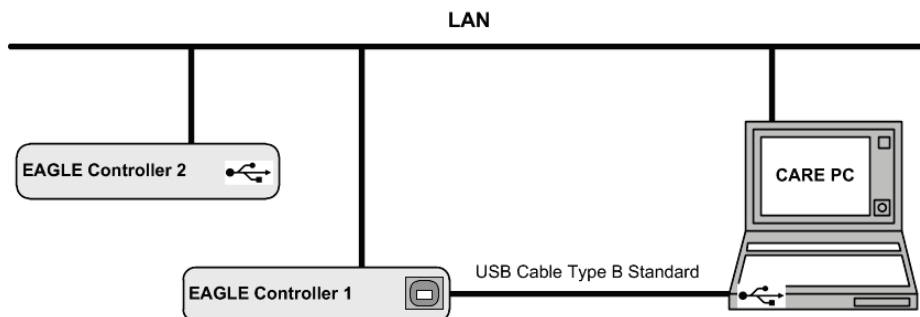

Fig. 2. Access to Eagle controller via USB

To locally connect to the Eagle controller via USB interface, an USB cable of type B standard can be used.

The USB connection type is mandatory for the initial setup of an Eagle controller and recommended due to a reasonable transfer rate (2 Mbit/s) and because no IP address changes are necessary before and after installation. In addition, the LAN connection can be used in parallel and uninterruptedly.

Default IP address

For access via USB, the Eagle has a factory default IP address 192.168.255.241 and Network Mask 255.255.255.0.

Procedure:

See Establish Local Connection via USB Cable section in CARE User Guide EN2Z-0970GE51.

IP Address Allocation

To establish any of the described connections, IP addresses must be allocated to the relevant network components such as BACnet client and Eagle controller(s).

For further information, please refer to "Setup BACnet Controller" section in CARE User Guide EN2Z-0970GE51.

Network

Based on its design as an IP device (see also "Communication Protocols"), the Eagle controller "speaks" BACnet over IP (Internet Protocol) and hence, can be integrated smoothly and without the need for additional devices into any network infrastructure having regard to the corresponding network security mechanism.

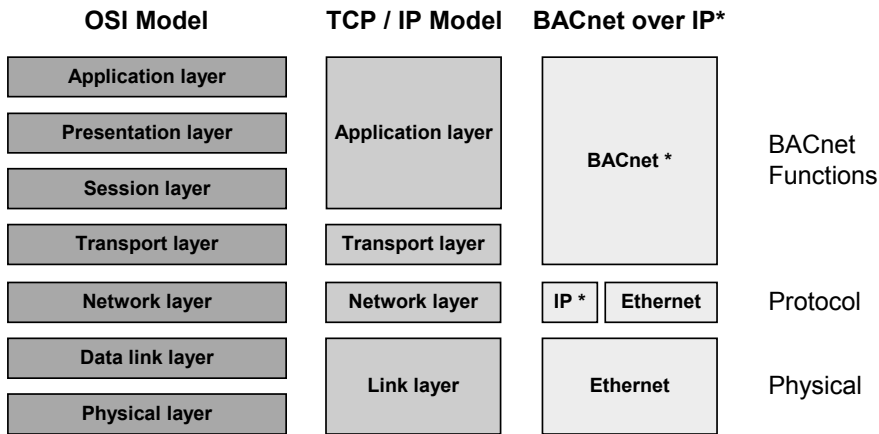

Fig. 3. Networking model of Eagle controller

Network Load The network load for one Eagle controller in combination with one BACnet client is about 0,1 % network load in a 100 Mbit network.

These figures are based on the following assumptions:

- 20 BACnet properties per display
- BACnet properties are updated by 5 BACnet client displays simultaneously
- Each property is updated every 5 s. One update message for a simple property needs 100 bytes, for a complex property 200 bytes.

Calculation: 5 displays * 20 properties/display * 150 bytes/property * 1 update/5 s = 30000 bits per second.

If alarms should be received and properties should be in trend, everything should not consume more than 100 Kbits/s, which is 0,1 % in a 100 Mbit network.

Communication Protocols

BACnet/IP - ISO 16484-5

Communication with other Eagle® controllers, with 3rd-party BACnet® devices, with Honeywell Enterprise Buildings Integrator™ and SymmetrE® front-ends, and with 3rd-party BACnet® front-ends is based on the international BACnet® Protocol. More details on the BACnet® Interoperability can be obtained from the Eagle® Protocol Implementation Conformance Statement (PICS).

BACnet MSTP – ISO 16484-5

Communication with other BACnet controllers (Honeywell and 3rd-party) is based on the international BACnet Protocol.

LonTalk® - ISO 14908

Communication with with room and zone controllers, with Excel 50/500 controllers, and optionally with LonWorks® I/O modules is based on LonTalk®. A Free Topology Transceiver (FTT-10A or FT-X1) allows a communication speed of 78 KBaud..

HTTP

Eagle® can be operated using a standard Internet Explorer 9.0.x and Mozilla Firefox® 15.0.x. The required minimum screen resolution is 800 x 600 pixels. For more details, please refer to the "Operating the Eagle Web Interface" section.

FTP

The firmware and application are downloaded via the standard FTP (File Transfer Protocol).

SSH

SSH access to the Eagle controller is possible for the purpose of service and diagnostic of the Linux operating system and the Eagle firmware. In case this is needed, please contact your Honeywell representative.

SMTP

Simple Mail Transfer Protocol is used for the embedded Email alarming functionality of Eagle.

Time Synchronization	BACnet clients such as Centraline ARENA AX or 3 rd -party BACnet front-ends, can time sync the Eagle controller via the standard time sync or UTC time sync BACnet service. When having multiple Eagle controllers on a network without any BACnet client, the time of all devices on the bus supporting time sync can be synchronized using one source controller.
Front-Ends	<p>The Eagle controller communicates with BACnet front-ends only.</p> <p>Supported BACnet front-ends are:</p> <ul style="list-style-type: none"> • Centraline ARENA AX / Honeywell SymmetrE Software For more information, please refer to the following software release bulletins: <ul style="list-style-type: none"> – Centraline ARENA AX – Honeywell SymmetrE/EBI R31 SP4 or higher • XFI Software The XFI has not been tested yet with Eagle, but supports BACnet functionality.

Operation and Application Software

Programming	<p>The Eagle® is freely programmable using the CARE Engineering Tool and is thus ideal for all Building Control and Building Management tasks.</p> <p>This allows making use of standard, pre-tested and pre-documented application and control strategies.</p>
Application Control	Four selectable control loop speed classes (multitasking) with defined cycle times and switching tables allow tailored and highly effective applications control.
User Administration	<p>Your control system is protected by defined user access rights. This ensures that only authorized persons have access to the system data. There are six pre-defined user levels. The predefined user levels are arranged hierarchically and the sequence with descending priority is as follows:</p> <ul style="list-style-type: none"> • System Admin (128) • Project Admin (115) • Building Engineer (96) • Operator (64) • Tenant (32) • Guest (0) <p>Eagle® allows the definition of up to 128 user levels by default. The above mentioned user levels are available. Each user level can have different read and write rights assigned, e.g. Display Communication Settings, Create and Delete Calendars, Change clock settings, etc. Several users with individual passwords can be defined for each user level.</p> <p>NOTE: There is no limit to the number of users per user level.</p>
Datapoints	<p>Datapoints called "Objects" in BACnet terms are the basis of the Eagle – BACnet system. Datapoints contain system-specific information such as values, status, limit values, and default settings. The user has easy access to datapoints and the information they contain.</p> <p>The user can recall and modify information in the datapoints.</p>
Alarm Handling	<p>Alarm handling is defined and realized in the application.</p> <p>BACnet alarming On datapoint level, alarming is done by the BACnet intrinsic reporting service.</p> <p>The following point changes may generate alarm messages:</p> <ul style="list-style-type: none"> • Exceeding limit values (analog points and pulse converter point) • Changes of state (binary and multi-state input and value datapoints) • Faults (due to, e.g. LON communication errors or e.g. sensors breaks)

The algorithmic alarming uses the standard BACnet “Event Enrollment Object” and is used to provide the following functionality:

- Warning limits for analog datapoints (Min. and Max. warning limits, in addition to the Min and Max Alarm limits)
- Alarming for datapoint change between “auto” and “manual”
- Alarming for missing or late acknowledgement of alarms
- Maintenance alarming, based on elapsed runtime of datapoints or number of state-changes of datapoints.
- Alarming for unsuccessful transmission of Email alarms
- Alarming for stopped or started plants within Eagle

Alarming is further supported by notification class objects, which contain information required for the distribution and segregation by time and addresses of alarm/event notifications within a BACnet system.

Notification class objects allow up to 256 alarm priorities. By default, CARE provides 3 notification class objects matching the BACnet client’s alarm priorities:

- Urgent
- High
- Low
- Journal

IMPORTANT

The internal ring alarm buffer takes max. 100 alarms.

Eagle does also support the BACnet algorithmic alarming service.

Time Programs

Time programs comprise schedules and calendars.

Schedules

Schedules are daily and weekly time programs.

Whenever you want, you can use schedules to enter the set point or status for any datapoint.

Schedules are assigned to plants. Each plant of a controller can have multiple schedules assigned and each schedule can command datapoints of that plant.

Each schedule specifies a list of datapoint properties to command (switchpoints) on a weekly basis. The week program defines the normal daily activity of the system by specifying which switchpoints are to be commanded each day of the week. The week program applies to a definable time period. There is only one-week program per schedule.

Schedules offer 16 write priorities that define the priority for writing to the present value of output and value datapoints. Note that only priorities 9 to 16 are allowed in the controller.

The write priority applies only to the present value property of virtual points and output points. The write priority is ignored for all other types of properties.

For every schedule (week program), specific programs called exceptions can be created. Exceptions have higher priority than the week program and will overwrite the week program for a definable time period. Exceptions can be one of the following four time periods:

- Specific Date
e.g. Christmas Eve or 5.5., the whole of May, or the whole year of 2004
- Date Range
e.g. Summer holidays from 29.7-7.9.2004
- Recurring Event
e.g. every last Friday of every month
- Calendar Reference
A project-wide calendar provides dates, e.g. regional holidays and public/religious festivals or any other particular date. The time period can be a specific date, a date range or a recurring event.

Calendars

Calendars contain exception days or periods, e.g. Christmas, holidays. Calendars are valid for the whole project, and are executed in each controller but apply only to those schedules, which reference calendars. Changes in multiple particular controller schedules can be quickly made by simply changing a calendar in one controller. Thus project-wide scheduling can be influenced.

Trending

Trending (collection and storage of historical data) can be initiated and configured via the Eagle Web Interface and via BACnet clients. Trend data have unlimited lifetime and survive an application download. Trend objects must be explicitly deleted via Eagle Web Interface or BACnet. This deletes also the corresponding trend records. The trended object may be a local or a reference point in the same controller and the trended property may be integer or floating point, e.g. point value, point state, alarm limit, time stamp.

Trending via the Eagle Web Interface

Trend data are dynamically created in the controller and can be saved in a .CSV file. Trend data is stored on the integrated Flash memory of the EAGLE, and can hold up to of 360,000 trend records distributed among 497 trend log objects. In addition, three trend log objects are used for LON statistic trending. A single trend log object can include max. 2.880 trend records (max. trend buffer size). One trend record equals 30 bytes. Trend data storage can be in 'Ringbuffer' mode or in 'Stop When Full' mode.

Trending via BACnet Client

BACnet clients like the Centraline ARENA AX will use the BACnet 'read range service' to readout trend values from the Eagle controller. Trend recovery for BACnet clients, specifically ARENA AX and SymmetrE optionally provide an automated recovery mechanism which allows to "backfill" missing trend data on the BACnet client side with trend values from the Eagle controller. This mechanism is described in the BACnet standard as "Automatic Trend Retrieval" (BBIB-ATR).

Protocolling

In the context of the Eagle controller, "protocolling" means creating a log of the values or states of the datapoints, which have been assigned to this particular EAGLE controller. Using the Eagle Web Interface, the user must place the corresponding datapoints into "trend". If, at some later point in time, i.e. after lengthy operation, a protocol of the Eagle controller's history is desired, the corresponding trend data can be generated, viewed, and downloaded (in CSV format) via the browser interface.

The trend data can even be downloaded into a BACnet client if this client supports this BACnet service.

When connected to the Eagle controller via Internet Browser, all other Eagle controllers of the same project can be operated without the necessity of a new login.

Backup/Restore

The Eagle controller supports the BACnet Backup/Restore functionality by the backup/restore of the application files.

When performing a backup/restore of the application files, the following must be noted:

- Online changes which happened up to 90 sec. before the back-up was started, may not be included in the back-up.
- Do not restore the application if the LON interface of the controller has been changed via CARE.
- The backup does not contain trend definition and LON commissioning information.

Diagnostics

- LON Diagnostics** The Eagle Web Interface allows trending and display of LON specific parameters, e.g. messages received and transmitted, communication errors, etc.
- BACnet Diagnostics** The Eagle Web Interface allows display and analysis of BACnet services which have been initiated or executed by Eagle. Furthermore the EAGLE web interface allows searching for BACnet objects in a BACnet network.

EAGLE WEB INTERFACE

The Eagle® controller is operated via a standard Internet Explorer 9.0.x and Mozilla Firefox® 15.0.x.

By default, an integrated web server provides all operation pages for a full browser-based operation.

Through the consequent use of software standards, any PC platform can be used as an operator interface (client). In addition to laptops, desktop PCs or panel PCs can also be used for direct flush mounting into cabinet doors (IP65).

Other than the operating system and Internet Explorer 9.0.x or Mozilla Firefox® 15.0.x, no software needs to be installed on the client PCs.

The screenshot displays the EAGLE web interface for the 'MEL_5_3_1.Rambla_C3.Datapoints' page. The interface is divided into several sections:

- Controller Selection:** Shows 'MEL_5_3_1.Rambla_C3.Datapoints' and a dropdown menu for 'Rambla_C3'.
- Datapoint Filter:** Includes a 'Plant' dropdown (set to '<All>'), a 'Type' section with checkboxes for various input/output types (e.g., Analog Input, Binary Input, Multi-State Input, etc.), and a 'Name' search field.
- Datapoint List:** A table listing various datapoints with columns for Name, Description, Value/Unit, Event State, Type, and status indicators (ALM, FLT, OVR, OOS).
- Footer:** Contains 'Language: English', 'Refresh: 30 sec', 'Logout (SystemAdmin)', the date '12/03/2012 11:43', and 'Alarm Status (13 / 10)'.

Name	Description	Value/Unit	Event State	Type	ALM	FLT	OVR	OOS
UBC_A1		8.93 V	Normal	AI	<input type="checkbox"/>	<input type="checkbox"/>	<input type="checkbox"/>	<input type="checkbox"/>
UBC_AI2		8.92 V	Normal	AI	<input type="checkbox"/>	<input type="checkbox"/>	<input type="checkbox"/>	<input type="checkbox"/>
UBC_AITemp		0.00 °C	Fault	AI	<input checked="" type="checkbox"/>	<input checked="" type="checkbox"/>	<input type="checkbox"/>	<input type="checkbox"/>
UBC_AI_xlweb2_188_1		8.92 V	Normal	AI	<input type="checkbox"/>	<input type="checkbox"/>	<input type="checkbox"/>	<input type="checkbox"/>
UBC_AI_xlweb2_188_2		8.91 V	Normal	AI	<input type="checkbox"/>	<input type="checkbox"/>	<input type="checkbox"/>	<input type="checkbox"/>
UBC_AO_Alarm_1		0.00 %	Low Limit	AO	<input checked="" type="checkbox"/>	<input type="checkbox"/>	<input type="checkbox"/>	<input type="checkbox"/>
UBC_AO_Alarm_2		0.00 %	Low Limit	AO	<input checked="" type="checkbox"/>	<input type="checkbox"/>	<input type="checkbox"/>	<input type="checkbox"/>
UBC_AO_SpaceTemp		1.00 °C	Normal	AO	<input type="checkbox"/>	<input type="checkbox"/>	<input type="checkbox"/>	<input type="checkbox"/>
UBC_AO_xlweb2_188_1		60.00 %	Normal	AO	<input type="checkbox"/>	<input type="checkbox"/>	<input type="checkbox"/>	<input type="checkbox"/>
UBC_AO_xlweb2_188_2		60.00 %	Normal	AO	<input type="checkbox"/>	<input type="checkbox"/>	<input type="checkbox"/>	<input type="checkbox"/>
UBC_AV_Alarm_1		0.00 K	Low Limit	AV	<input checked="" type="checkbox"/>	<input type="checkbox"/>	<input type="checkbox"/>	<input type="checkbox"/>
UBC_AV_Alarm_2		0.00 K	Low Limit	AV	<input checked="" type="checkbox"/>	<input type="checkbox"/>	<input type="checkbox"/>	<input type="checkbox"/>
UBC_AV_Cycle_Ramp_Off_Time		300.00	Normal	AV	<input type="checkbox"/>	<input type="checkbox"/>	<input type="checkbox"/>	<input type="checkbox"/>
UBC_AV_Cycle_Ramp_On_Time		300.00	Normal	AV	<input type="checkbox"/>	<input type="checkbox"/>	<input type="checkbox"/>	<input type="checkbox"/>
UBC_AV_Cycle_Sinus_Off_Time		15.00	Normal	AV	<input type="checkbox"/>	<input type="checkbox"/>	<input type="checkbox"/>	<input type="checkbox"/>

For detailed information on the operation of the Eagle Web Interface, please refer to the "Operating the Eagle Web Interface" section, p. 103.

USER ADMINISTRATION

The user administration (user access manager in CARE) is used for defining user rights according to the required functions. These definitions are done in CARE firstly by creating the users and issuing the functions they should have permission for in the Eagle Web Interface. In addition, the user administration (user access manager) is used for defining the language and decimal places of values the Eagle Web Interface should display. User rights can be changed in the Eagle Web Interface dependent on the predefinitions of the user in CARE.

NOTE: All users can operate all controllers of a project. Changes in the user administration will be automatically synchronized among all Eagle controllers in the same project.

Access Rights List

An access rights list for a complete project will be created by assigning predefined user levels to all executable functions (access rights) of the Eagle Web Interface. An access rights list may look as follows:

Access Right	User Level
Change Communication Settings	System Admin
Create and Delete Schedules	Building Engineer
Create and Delete Trends	Building Engineer
Display Diagnostics	Tenant

The predefined user levels are arranged hierarchically and the sequence with descending priority is as follows:

- System Administrator (128)
- Project Administrator (115)
- Building Engineer (96)
- Operator (64)
- Tenant (32)
- Guest (0)

Example:

When assigning 'Operator' to 'Create & Delete Calendars', a user having a user (access) level below 'Operator', for example 'Tenant' or 'Guest', is not able to create and delete calendars. A user having a user level equal to or higher than 'Operator', for example 'Building Engineer' or 'Project Admin' is able to create and delete calendars.

NOTE: When creating a project in CARE, the System Admin level is automatically assigned to the user who has created the project.

Only the user who has System Admin user level can create new users and edit or delete existing users.

User Profile

For each user within a project, a user profile with the following properties will be created:

- User name
- User (access) level
- Language
- Decimal places
- Password
- Access rights
- Email address(es)

A user is identified by its user name. One of the predefined user levels will be appropriately assigned to the user (name).

Due to the access rights list definitions, this assignment automatically determines the set of access rights, which the user is allowed to execute in the Eagle Web Interface.

All users having a user level higher than or equal to the assigned user level will have this access right enabled in the Eagle Web Interface, all others will not.

NOTE: A user can carry out his/her assigned access rights in all controllers of the project.

In addition, the user profile includes the settings of the language in which the Eagle Web Interface is displayed and the number of decimal places of values to be displayed in the Eagle Web Interface.

For the email alarming function, the user must have an email address assigned which allows receiving alarm emails generated by the Eagle controller. For each user, max. 5 email addresses can be assigned.

Finally, a password for each user must be issued for secure operation of the Eagle Web Interface.

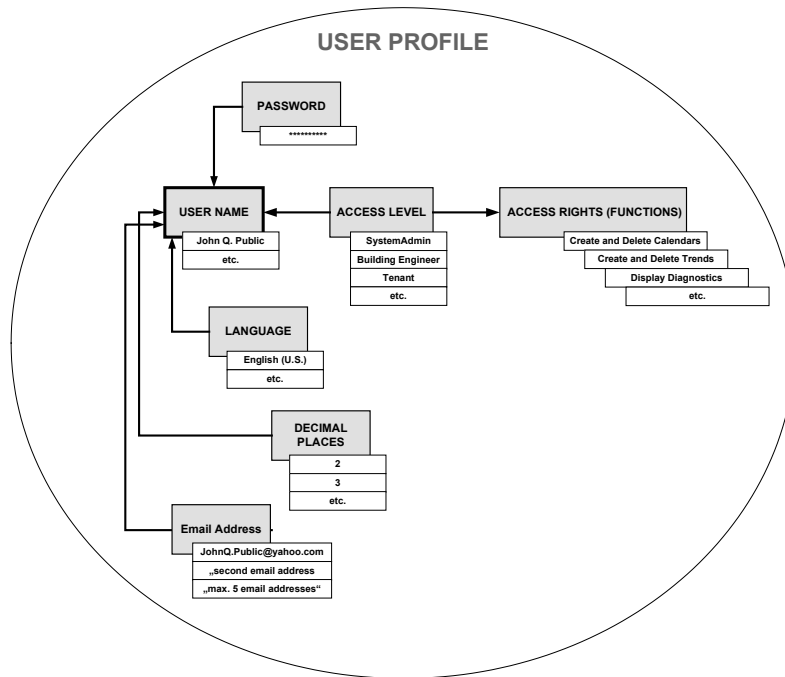

Fig. 4. User Profile Creation

Implications of CARE Settings

For some items such as datapoints and control loops, access rights can be predefined in CARE only. Dependent on the settings done in CARE, some items may not be visible in the Eagle Web Interface.

Example: When assigning the read access level 'building engineer' to all analog inputs, no analog inputs are visible for users having a user access level assigned which is lower than the 'building engineer' level, e.g. for users with the user access levels 'operator', 'tenant', or 'guest'.

NOTE: The option 'HMI Pin' is provided as password for the onboard HMI.

DATAPOINTS

An Eagle® controller supports up to 600 (52 for the CLEA2014xxx models) physical datapoints, called 'objects' in BACnet terms and an unlimited number of value datapoints, called 'value objects' in BACnet terms.

A datapoint has different properties according to its type. Properties are displayed and can be modified via BACnet clients, and a standard browser on operator interfaces such as laptops, desktop PCs, or panel PCs. Properties contain information about the given datapoint. Among many more, this information could be:

- Present value
- Transition events
- Descriptions
- Input limits values
- Operating status
- Elapsed run time

The following sections provide more-detailed information about the different kinds of datapoints and datapoint properties and explain which properties are assigned to which datapoints.

Physical Datapoints

Physical datapoints are inputs and outputs attached to hardware devices like sensors and actuators.

The following are examples of physical datapoints:

Universal Inputs	NTC20kΩ / 0...10V / slow BI, and NTC20kΩ / 0...10V fix pull-up / slow BI to connect outside air temperature sensors, for example.
Analog Outputs	Outputs with a continuous 0...10 V (max. 1 mA) output signal for controlling continuous actuators
Binary Inputs	Inputs (open = 24 V / closed 2.0 mA / totalizer 15 Hz) for processing voltage-free signals (switches, contacts, counters).
Binary Outputs	Outputs (relay N.O. or N.C. contact) for driving three-position actuators, for example, a damper motor; two position devices, for example, a circulation pump; and pulsed outputs
	NOTE: Analog Outputs can also be used as Binary Outputs, by sending 0 V or 10 VDC.
Multi-State Inputs	Inputs used for equipment feedback (Automatic, On, Off)
Multi-State Outputs	Outputs controlling multi-stage fans (0, 1, 2, 3)
Pulse Converter	Digital inputs for processing pulsed signals up to 20 Hz (depending on I/O module specifications), for example, metered energy consumption.

Value Datapoints

Value datapoints are values (intermediate results and parameters) computed while the application program is running. In contrast to physical datapoints, value datapoints are not directly connected to hardware devices.

A typical example of a value datapoint is a room temperature setpoint.

Access via datapoint name

During system operation, you may need to access these values. To simplify this process, you can include value datapoints in the datapoint list, where you can access them directly via their datapoint name.
 Like physical datapoints, value datapoints, too, can have different properties; for example, they can specify a manual value, set minimum and maximum values, or log trends.
 The following are types of value datapoints:

- Analog value points
- Binary value points
- Multi-state value points

Analog Value Datapoints

Analog value points are software points containing an analog value in the user program.

An analog value point could, for example, contain a flow temperature setpoint calculated from the room setpoint and the outside air temperature via the heating curve.

Binary Value Datapoints

Binary value points are software points containing a binary value in the user program.

For example, logical AND operation:
 The AND operation provides a logical 1 output when all input conditions are also logical 1. Otherwise the output is a logical 0. If the user program contains such an AND operation on different input conditions, then the output could be available as a binary value datapoint.

Multi-state Value Point

Multi-state Value datapoints allow switching 32 stages (including the "off stage") of physical digital inputs or outputs. Depending on the number of stages, the multi-state value point provides up to 32 editable stage texts, e.g., stage 1, stage 2, stage 3, etc, to be edited in CARE.
 A typical example would be a multi-state room setpoint for room control with stages such as "Unoccupied", "Stand-by" and "Occupied".

Reference Datapoints

If your control and monitoring system contains more than one controller, the controllers communicate with one another via the BACnet bus BACnet/IP or/and via BACnet MS/TP. This enables one controller both to read and set the datapoints from other controllers, and to read values of 3rd-party BACnet devices of the project and external BACnet devices which are not in the project.
 This data communication is realized via so-called reference input/output points. They always originate in or write to another plant and may originate in or write to another controller.

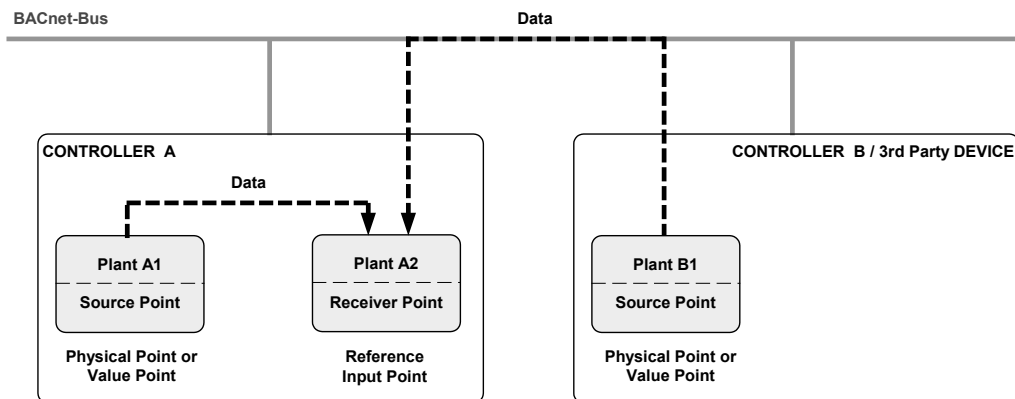

NOTE: Controllers / 3rd Party Devices can be in the same or in different projects.

Fig. 5. Data exchange via reference datapoints on the BACnet bus

Please refer also the datapoint property description in the "Reference" section.

Mapped Datapoints

The Eagle controller may have I/O devices connected via the LONWORKS network. LONWORKS network variables (or individual fields of structured network variables) can be mapped to the property "Value" of physical datapoints (AI, BI, AO, BO, MI, MO). Note that multi-state points on BACnet start counting from 1 while enumerated NVs start counting from zero. So a +1 conversion table must be applied for NVI mapping and a -1 conversion table must be applied for NVO mapping.

For more information on LONWORKS network variables and datapoint mapping, please refer to the CARE User Guide, EN2Z-0970GE51.

Datapoint Properties

Each datapoint type has associated with it various parameters, which allow the user to set, e.g., the datapoint name, the level of access protection, alarm behavior, and other options. These parameters are called properties. Each property performs a specific function related to the datapoint.

Not all properties are available for every datapoint type.

Datapoint Refreshing

The following properties will be simultaneously refreshed to a BACnet client or the Eagle Web Interface:

- Present value
- Operating mode
- Reliability
- Status flags
- Event state
- Event time stamp
- Acknowledged transition
- Command priorities
- Active/Inactive texts
- Elapsed active time
- Time of active time reset
- State texts
- Feedback value
- Time of present value reset

NOTE: A complete list of all properties associated with the various datapoint types can be found in the section Datapoint Properties Overview.

Operating Mode

The user is able to switch each datapoint between manual and automatic operation.

Automatic

Under automatic operation, the controller processes the values at the inputs, for instance from temperature sensors. For outputs, under automatic operation, the status shown by the user/time switch program is adopted, e.g., 'Heating circuit pump off'.

Manual

During manual operation, the controller uses the manual values, for example, 'flow temperature setpoint = 60°C'. Outputs adopt the preselected condition, for example, 'Heating circuit pump on'.

Local Manual Override

If manual override controls are present on either the analog output or digital output modules, then the status of these controls (automatic/manual override) is displayed in the Eagle Web Interface.

Via the standard 'Priority Array' functionality of BACnet, the manual override read and write control is possible.

Properties Descriptions

How to Read the Datapoint Properties Description

In the following, all datapoint properties which exist in the Eagle Web Interface and in CARE are described. Each property description starts with a table that explains:

- which datapoints the property applies to
- where the property is available, either in CARE or in the Web Interface or in both of them
- if the property is editable and where (Web Interface and/or CARE) it can be changed.
- the corresponding equivalent name, if the property name is different in the Web Interface and in CARE

All valid items are highlighted in gray. Non-valid items remain in white.

Examples: The following table explains the **Active / Inactive Text** property. In this case the property applies to the BI, BO and BV datapoint types. It is available in the Web Interface and in CARE. It can be edited in CARE but not in the Web Interface. In the Web Interface the property is not called **Active / Inactive Text** but is displayed as Auto or Manual property.

Datapoint Type	AI	AO	AV	BI	BO	BV	MI	MO	MV	PC	RI	RO
User Interface	Web Interface						CARE					
Editing	-						X					
Equivalent	Auto, Manual											

The following table explains the **Ackn. (Acknowledged Transitions)** property. In this case the property applies to all datapoints except the RI (reference input). It is available in the Web Interface only. It cannot be edited at all and there is no equivalent.

Datapoint Type	AI	AO	AV	BI	BO	BV	MI	MO	MV	PC	RI	RO
User Interface	Web Interface						CARE					
Editing												
Equivalent												

In some exceptions, remarks in quotation marks are added. In the following table of the **Engineering Unit** property description, "assigned to value" means that the engineering unit is not available as property but is assigned to the current value of the datapoint.

Datapoint Type	AI	AO	AV	BI	BO	BV	MI	MO	MV	PC	RI	RO
User Interface	Web Interface						CARE					
Editing	<i>"assigned to value"</i>						X					
Equivalent												

Ackn. (Acknowledged Transitions)

Datapoint Type	AI	AO	AV	BI	BO	BV	MI	MO	MV	PC	RI	RO
User Interface	Web Interface						CARE					
Editing												
Equivalent												

Shows whether a transition has been acknowledged or not. By default, each transition will be acknowledged by the Eagle controller and the Ackn. Property is checked in the Eagle Web Interface. On the BACnet client, transitions can be set to be asked for acknowledgement by the operator manually.

Active / Inactive Text

Datapoint Type	AI	AO	AV	BI	BO	BV	MI	MO	MV	PC	RI	RO
User Interface	Web Interface						CARE					
Editing	-						X					
Equivalent	Auto, Manual											

To binary points, texts can be assigned in CARE to display the corresponding active or inactive state of the point in the Eagle Web Interface. The texts include active/inactive (passive) descriptions with unit, and number of states.

Example: Active / Inactive text assigned to binary output for switching a pump.

Unit	Number of states	State (0)	State (1)
1	2	OFF	ON
2	2	Stopped	Running

The actual state is displayed as present value in the Eagle Web Interface.

See also "Auto" and "Manual" sections.

Alarm Delay

Datapoint Type	AI	AO	AV	BI	BO	BV	MI	MO	MV	PC	RI	RO
User Interface	Web Interface						CARE					
Editing	x						X					
Equivalent												

The alarm delay determines how long a 'To-Off-Normal' or a 'To-Normal' transition must exist before an alarm is generated. Entering an alarm delay time of 10 seconds means that the limit value must be exceeded for at least 10 seconds before this datapoint generates an alarm. If the limit value only lasts for 7 seconds, then no alarm occurs. The alarm handling for a datapoint can be completely disabled by setting the alarm delay time to a value of 100000 or higher.

Alarm Text

Datapoint Type	AI	AO	AV	BI	BO	BV	MI	MO	MV	PC	RI	RO
User Interface	Web Interface						CARE					
Editing	-						X					
Equivalent												

For the property 'Alarm text', CARE allows entering personalized alarm texts for the different event states of an analog or digital point. The assigned alarm text is shown with the alarm, which is caused by the corresponding transition event.

Alarm texts can have 256 characters at maximum with no restriction on the used character type.

Analog points have twelve, Digital points have six possible event states. The following table shows the event states and examples for alarm texts:

Nr.	Analog Event States	Alarm Text Example	Digital Event States	Alarm Text Example
1	High Limit to Normal	Value below High Limit	Fault to Normal	Input OK
2	Low Limit to Normal	Value above Low Limit	Normal to Fault	Input Failure
3	Fault to Normal	Sensor OK	Off-Normal to Normal	Input back to Normal
4	Normal to High Limit	Value above High Limit	Normal to Off-Normal	Input Change to Alarm
5	Normal to Low Limit	Value below Low Limit	Fault to Off-Normal	
6	Low Limit to High Limit		Off-Normal to Fault	
7	High Limit to Low Limit			
8	Fault to High Limit			
9	Fault to Low Limit			
10	Normal to Fault	Sensor Break		
11	High Limit to Fault	Sensor Break		
12	Low Limit to Fault	Sensor Break		

Alarm Type

Datapoint Type	AI	AO	AV	BI	BO	BV	MI	MO	MV	PC	RI	RO
User Interface	Web Interface						CARE					
Editing	-						X					
Equivalent							Notify Type					

According to the BACnet Specification, events can be of the type 'alarm' or 'event'. On the BACnet client, alarms will be graphically indicated by blinking in the status line and shown in the alarm summary. Events will not be indicated in the status line and will be shown in the event summary.

The notify type can be defined and changed in CARE. In the Eagle Web Interface, the notify type (alarm type) is displayed only.

For all notification classes, notify type 'Alarm' must be used.

See also "Notify Type" section.

Alarm Value

Please refer to the "Alarm Value Enable" section.

Alarm Value Enable

Datapoint Type	AI	AO	AV	BI	BO	BV	MI	MO	MV	PC	RI	RO
User Interface	Web Interface						CARE					
Editing	x						X					
Equivalent							Alarm Value					

Defines the alarm condition of a binary input or value point when an alarm should be reported in case of binary input changes. The alarm condition can be either the active state or the inactive state of the point e.g. 0 or 1, ON or OFF, Up or Down. If the present value is equal to this condition for at least the alarm delay time, then an OFF-Normal event is generated. In addition an alarm delay can be entered.

Auto

Datapoint Type	AI	AO	AV	BI	BO	BV	MI	MO	MV	PC	RI	RO
User Interface	Web Interface						CARE					
Editing	x											
Equivalent												

Sets the datapoint in automatic (Auto) operation mode. In Auto operation mode, the datapoint shows the present value processed by the controller (sensor input values, time program output values).

See also "Active / Inactive Text" section.

BACnet Instance

Datapoint Type	AI	AO	AV	BI	BO	BV	MI	MO	MV	PC	RI	RO
User Interface	Web Interface						CARE					
Editing							-					
Equivalent												

The BACnet instance number is part of the internal BACnet addressing in every BACnet system (BACnet communication). The BACnet instance number of datapoints is not visible in the Eagle Web Interface and the user does not need the BACnet instance number in order to operate the Eagle controller.

The BACnet instance number of a device object is visible in the Eagle Web Interface.

When creating objects in CARE such as datapoints, schedules or calendars, CARE assigns an instance number to each object. The instance number is unique within the same object type but the same instance number may also exist in other object types. The instance number of the device object is unique on the whole BACnet network.

The following table shows examples of instances, which CARE automatically assigns to the corresponding BACnet objects while they are created:

Object Type	Instance Number
Analog input 1	1
Analog input 2	2
Analog input 3	3
Analog input 4	4
Analog input 5	5
Binary input 1	1
Binary input 2	2
Binary input 3	3
Binary input 4	4
Binary input 5	5

The instance number in combination with the BACnet object type information is one method in creating and adding a 3rd party BACnet device to the BACnet bus (see also "BACnet Object ID" section).

This information must be provided by or to the project engineer/vendor who is responsible for the 3rd party BACnet device to be added to the CARE project, or who is responsible for integrating the Eagle controller into a 3rd party BACnet system.

NOTE: In Europe it is common using the EDE data format for interchanging information between BACnet objects. For further information, please access the BACnet Interest Group Europe e.V. at:

<http://www.big-eu.org>

BACnet Object (Type)

Datapoint Type	AI	AO	AV	BI	BO	BV	MI	MO	MV	PC	RI	RO
User Interface	Web Interface						CARE					
Editing							-					
Equivalent												

The BACnet object type is part of the internal BACnet addressing in every BACnet system (BACnet communication). The BACnet object type is not visible in the Eagle Web Interface and the user does not need the BACnet object type in order to operate the Eagle controller.

In the BACnet standard, BACnet objects are classified in types.

Example: Analog inputs are of BACnet object type "analog input(0)", binary inputs are of BACnet object type "binary input(3)", devices such as the Eagle controller and 3rd party BACnet devices are of BACnet object type "device(8)"

The BACnet object type information in combination with the instance number is one method in creating and adding a 3rd party BACnet device to the BACnet bus (see also "BACnet Object ID" section).

This information must be provided by or to the project engineer/vendor who is responsible for the 3rd party BACnet device to be added to the CARE project, or who is responsible for integrating the Eagle controller into a 3rd party BACnet system.

The BACnet Object type defaults according to the BACnet convention are as follows (see next page):

BACnet Object	Object Type
Analog input	0
Analog output	1
Analog value	2
Averaging	18
Binary input	3
Binary output	4
Binary value	5
Calendar	6
Command	7
Device	8
Event enrollment	9
File	10
Group	11

Life safety point	21
Life safety zone	22
Loop	12
Multi-state input	13
Multi-state output	14
Multi-state value	19
Notification class	15
Program	16
Schedule	17
Trend log	20

BACnet Object ID

Datapoint Type	AI	AO	AV	BI	BO	BV	MI	MO	MV	PC	RI	RO
User Interface	Web Interface						CARE					
Editing							-					
Equivalent												

The BACnet object ID is part of the internal BACnet addressing in every BACnet system (BACnet communication). The BACnet object ID is not visible in the Eagle Web Interface and the user does not need the BACnet object ID in order to operate the Eagle controller.

The BACnet object ID is a unique ID within a BACnet device.

BACnet Object IDs must be provided by or to the project engineer/vendor who is responsible for the 3rd party BACnet device to be added to the CARE project, or who is responsible for integrating the Eagle controller into a 3rd party BACnet system.

The BACnet object ID will be kept unique within a CARE project and is calculated within CARE by the following Standard BACnet formula:

$$\text{BACnet object ID} = \text{BACnet object type} \times 2^{22} + \text{Object Instance number}$$

The typical object addressing within a BACnet system is done by using the device ID and the Object ID.

Change of State Count

Datapoint Type	AI	AO	AV	BI	BO	BV	MI	MO	MV	PC	RI	RO
User Interface	Web Interface						CARE					
Editing	x/-											
Equivalent												

Displays the number of state changes of the binary datapoint

Change of Value Increment

See "Increment" section.

Bit Mask

Datapoint Type	AI	AO	AV	BI	BO	BV	MI	MO	MV	PC	RI	RO
User Interface	Web Interface						CARE					
Editing	-						X					
Equivalent							Event Parameters					

The bitmask shows the values/conditions that are observed.

See also "Bit String(s)" and "Event Enrollment" sections.

Bit String(s)

Datapoint Type	AI	AO	AV	BI	BO	BV	MI	MO	MV	PC	RI	RO
User Interface	Web Interface						CARE					
Editing	-						X					
Equivalent							List of Values					

Bit String(s) shows the possible logical values (true, false) resulting from the comparison of the selected values/conditions and the underlying bit string mask.

See also "Bit Mask" and "Event Enrollment" sections.

Characteristic

Datapoint Type	AI	AO	AV	BI	BO	BV	MI	MO	MV	PC	RI	RO
User Interface	Web Interface						CARE					
Editing							X					
Equivalent												

If the datapoint should be mapped to a NV (see LON Mapping property) and the engineering units of both do not match, for example, the NV has °C and the datapoint has °F, a characteristic (conversion table) must be assigned. Default characteristics are delivered with the CARE software.

Examples: 2-10 V = 0-100 %
 Linear input
 Direct out 0-100 %
 +1
 -1
 etc.

For example, the characteristic "Linear input" converts volts (NV value) into percent (datapoint value) as follows:

NV value	DP value
0,000	0,000
10,000	100,00

COV Period

See "Period" section.

Current Value

Datapoint Type	AI	AO	AV	BI	BO	BV	MI	MO	MV	PC	RI	RO
User Interface	Web Interface						CARE					
Editing	"Reset to"											
Equivalent												

Shows the current accumulated value of the pulse converter. The current value can be changed by reset.

Datapoint Name

Datapoint Type	AI	AO	AV	BI	BO	BV	MI	MO	MV	PC	RI	RO
User Interface	Web Interface						CARE					
Editing	-						X					
Equivalent												

Name assigned to each point for operator use in locating and commanding the point. This name must be unique within a controller, and this is guaranteed by CARE.

Example:

The temperature of a room is recorded at a sensor input, and then the associated datapoint name could be as follows:

Room_Temp.1.10 (Room temperature, 1st floor, room 10)

The datapoint can be accessed directly by selecting this name in the Eagle Web Interface or the BACnet client.

Point names can have a maximum of 40 alphanumeric characters. They must not include Tabs, double quotes, space characters and the following characters, ?, *, : , / , \ , < , > . All other printable characters are allowable (A-Z, 0-9, +, -, _, äöüßÄÖÜëè@\$\$%&#, etc). For example, 12A is a datapoint name, but 12 is not.

It is not recommended to use quotes or double quotes!

A project may use [ISO 8859-1](#) or ANSI X3.4 characters. All BACnet Servers on a network should use the same character set (Honeywell and 3rd party devices).

IMPORTANT

It is recommended not to use characters, which are not part of ANSI X3.4 (US-ASCII). Note that the max. length of the datapoint name for Lon points should not exceed 13 characters (see Lon point property). But the BACnet Datapoint name may be longer.

Deadband

Datapoint Type	AI	AO	AV	BI	BO	BV	MI	MO	MV	PC	RI	RO
User Interface	Web Interface						CARE					
Editing	x						X					
Equivalent												

Defines the value of the deadband in order to set off an alarm of event type 'To-Normal'. For this, the present value must, for at least the defined alarm delay (time), remain within the range:

Low limit plus deadband and high limit minus deadband

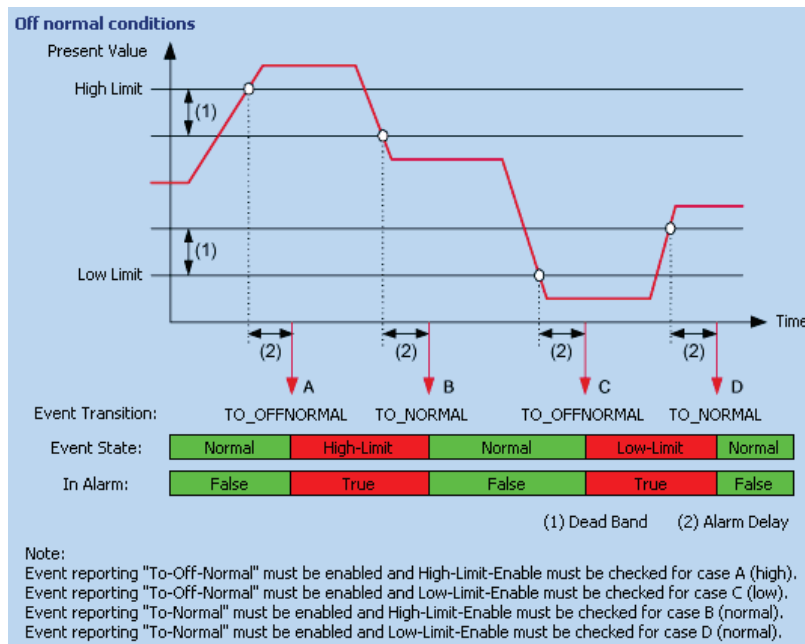

Fig. 6. Deadband (1) of analog datapoints

Description

Datapoint Type	AI	AO	AV	BI	BO	BV	MI	MO	MV	PC	RI	RO
User Interface	Web Interface						CARE					
Editing	-						X					
Equivalent							Descriptor					

Shows the descriptive Text, which has been entered as Descriptor for the datapoint in CARE.

A controller contains up to 600 physical datapoints and an unlimited number of value datapoints. When creating datapoints, an individual datapoint name is assigned to each of these datapoints.

Plain-language descriptors can be created with an unlimited number of characters each. These descriptors are then assigned to datapoints via the property "Descriptor".

Descriptors complete the information concealed behind the datapoint name. They can contain, for instance, a reference to a section of a building. The following list is an example of the relationship between datapoint names and descriptors:

Datapoint Name	Descriptor
Room temp floor 1	Heating circuit, West wing
Room temp floor 3	Heating circuit, West wing
Room temp floor 10	Heating circuit, East
Room temp corridor	Heating circuit, East
Flow temp floor 1	Heating circuit, West wing
Lights floor 1	Building section V
Lights corridor	Building section V

Descriptor

See "Description" section.

Direct/Reverse

Datapoint Type	AI	AO	AV	BI	BO	BV	MI	MO	MV	PC	RI	RO
User Interface	Web Interface						CARE					
Editing	X						X					
Equivalent												

Allows turning the direction of a 0-10 V characteristic.

Direction

Datapoint Type	AI	AO	AV	BI	BO	BV	MI	MO	MV	PC	RI	RO
User Interface	Web Interface						CARE					
Editing	-						X					
Equivalent							Lon Point					

Shows whether a mapped datapoint is mapped to an input NV (NV in) or an output NV (NV out).

See also "Lon Point" section.

Engineering Unit

Datapoint Type	AI	AO	AV	BI	BO	BV	MI	MO	MV	PC	RI	RO
User Interface	Web Interface						CARE					
Editing	<i>"assigned to value"</i>						X					
Equivalent												

Engineering units are pre-defined by the BACnet standard and will be assigned to datapoints in CARE. In the Eagle Web Interface, the present value is displayed with the assigned engineering unit.

Examples:

If, for instance, the external temperature is measured by an analog datapoint, the engineering unit of this datapoint must be set to "°C" or "°F". If the electrical load is detected by a pulse converter input, the engineering unit must be set to "kWh" for kilowatt-hours.

In the Eagle Web Interface, engineering units are displayed read only.

EOV / EOJ Optimization

Datapoint Type	AI	AO	AV	BI	BO	BV	MI	MO	MV	PC	RI	RO
User Interface	Web Interface						CARE					
Editing	x						X					
Equivalent												

Defines whether the datapoint should be optimized or not, if the datapoint is used as setpoint for energy optimized heating or ventilation (EOH or EOJ).

Event

Datapoint Type	AI	AO	AV	BI	BO	BV	MI	MO	MV	PC	RI	RO
User Interface	Web Interface						CARE					
Editing	"see Reporting"						X					
Equivalent							Reporting					

Shows the transition types that can be selected for reporting:

- To Off-Normal
The alarm reaches off-normal state, that is, the datapoint value exceeds the high limit, or remains under the low limit.
- Back To-Normal
The alarm is going to normal state, that is, the value of the datapoint remains under the high limit, or exceeds the low limit.
- To Fault
The alarm originates in a fault such as sensor break, etc. (depends on point type).

IMPORTANT

Always enable both options, 'To Off-Normal' and 'Back To-Normal', otherwise you will miss one of the corresponding alarms.

In the Eagle Web Interface, the transition type is selected by checking the **Reporting** checkbox.

See also "Transition Events" and "Alarm and Event Priority Classification" sections.

Event Enrollment

Datapoint Type	AI	AO	AV	BI	BO	BV	MI	MO	MV	PC	RI	RO
User Interface	Web Interface						CARE					
Editing	x						X					
Equivalent												

The primary purpose of the Event Enrollment object is to define an event and to provide a connection between the occurrence of an event and the transmission of a notification message to one or more recipients. The Event Enrollment object contains the event-type description, the parameters needed to determine if the event has occurred (Algorithmic Change Reporting), and a device to be notified. Alternatively, a Notification Class object may serve to identify the recipients of event notifications. A device is considered to be "enrolled for event notification" if it is the recipient to be notified or one of the recipients in a Notification Class object referenced by the Event Enrollment object. Event Enrollment objects are the basics for algorithmic change reporting.

See also "Bit Mask", "Bit String(s)", and "Time Delay" sections.

Event State

Datapoint Type	AI	AO	AV	BI	BO	BV	MI	MO	MV	PC	RI	RO
User Interface	Web Interface						CARE					
Editing	-											
Equivalent												

For any datapoint type, an application and/or product specific value range is defined in which the point is in the operating (event) state 'Normal'. If the point value has changed due to exceptional situations, the event state of a datapoint can be either 'Off-Normal' or 'Fault'.

The event states can be shortly described as follows:

Normal

Point is in normal operating state.

Off-Normal

Point value is out of normal range.

Fault

Point is prevented from proper operation. Point value can be in normal or out of normal range. Due to the maloperation of the point, the value is unreliable.

Causes for a fault can be, for example sensor and cable breaks. See “Status Flag indications for details.

High Limit

Point value has exceeded the high limit. Special case of the Off-Normal state of analog inputs, analog outputs, and analog value points (see also Alarm range properties in the table below).

Low Limit

Point value has dropped below the low limit. Special case of the Off-Normal state of analog inputs and outputs (see also Alarm range properties in the table below).

Fault

NOTE: The Fault property exists twice. In one case, it displays the actual status of certain datapoints, in the other case; it allows selecting which condition should be the fault condition.

Display of actual status

Datapoint Type	AI	AO	AV	BI	BO	BV	MI	MO	MV	PC	RI	RO
User Interface	Web Interface						CARE					
Editing	-											
Equivalent												

Indicates the fault status of the datapoint. When the ‘Fault’ status flag is enabled, the datapoint or the physical input is not reliable, e.g. in case of sensor break (Open Loop). See “Status Flag Indications” for details.

NOTE: Multiple flag indications may be possible.

Alarm reporting of Faults:

The ‘Fault’ status of a point will generate an alarm if a notification class is selected.

Example: A ‘To-Fault transition’ will always enable the ‘In Alarm’ flag. Hence both, the ‘In Alarm’ and the ‘Fault’ status flags are enabled.

Definition of fault condition

Datapoint Type	AI	AO	AV	BI	BO	BV	MI	MO	MV	PC	RI	RO
User Interface	Web Interface						CARE					
Editing	x						X					
Equivalent	Is Fault Condition											

Defines the state which indicates and sets off a ‘Fault’ event. If enabled, the fault text of the corresponding transition event is displayed.

Example:

States	Fault	Fault Text Display
1	NO	NO
2	YES	YES

See also "Is Fault Condition" section.

Feedback Value

Datapoint Type	AI	AO	AV	BI	BO	BV	MI	MO	MV	PC	RI	RO
User Interface	Web Interface						CARE					
Editing	X						X					
Equivalent												

Defines the datapoint that should provide the value for feedback control in case of BACnet fault and command failure alarms. The feedback point must be a input of the same type. The selected feedback point will not be available on the controller HMI and HTML web interface.

NOTE:

The feedback point must not be used in a control loop since as a result the control loop will not be executed properly.

FIO Mapping

Datapoint Type	AI	AO	AV	BI	BO	BV	MI	MO	MV	PC	RI	RO
User Interface	Web Interface						CARE					
Editing												
Equivalent												

Shows the Field Input Output details such as:

- Mapping
PV that is I/O is mapped to present value
- Name
name of the datapoint/NV
- Type
data type of present value, e.g. float, integer, or SNVT_count for NVs
- Direction
input or output and source hardware (onboard, panel bus, LON bus)

The settings depend on the kind of module the datapoint is assigned to (Onboard, panel bus, LON bus)

Fixed Prio

Datapoint Type	AI	AO	AV	BI	BO	BV	MI	MO	MV	PC	RI	RO
User Interface	Web Interface						CARE					
Editing							X					
Equivalent												

The Fixed Prio(rity) property allows saving the last value of an analog value (AV), or an output (AO, BO, MO) during the power cycle of the controller. The value is saved in the goldcap buffer RAM of the controller. The fixed prio property is written to priority level 9 in the priority array. As long as no value is written to the priority level 8, the value of priority level 9 will be saved cyclically in the NAND Flash and re-read after the re-start of the controller. After then the value can be overwritten by RACL.

High Limit Enable

Datapoint Type	AI	AO	AV	BI	BO	BV	MI	MO	MV	PC	RI	RO
User Interface	Web Interface						CARE					
Editing	x						x					
Equivalent												

The High Limit Enable property defines if high limit alarms are generated on the BACnet bus. The following conditions must be true for the system to generate an alarm:

- High limit is exceeded and this condition remains present for at least the defined alarm delay (time)
- Transition events 'To-OffNormal' and 'To-Normal' are enabled
- Notification class (urgent, high or low) is allocated to this point
- Notify type is set to 'Alarm' (not 'Event')

If all of these conditions are true, then an alarm of event type 'To-Off-Normal' is set off.

The high limit can be predefined in CARE and changed in the Eagle Web Interface later.

NOTE: According to the BACnet standard, disabling the High Limit does only disable the reporting of the High Limit Alarm onto the BACnet bus. When the High Limit is exceeded, the datapoint will still be "in Alarm", and if a BACnet front-end is polling the alarms of a BACnet controller, also datapoints with High Limit disabled will be displayed on the BACnet front-end as being "in Alarm".

With Eagle it is possible to disable both High and Low Limit alarms at the same time, if the alarm delay time is set to 100,000 sec or longer.

In Alarm

NOTE: The In Alarm property exists twice. In one case, it displays the actual status of certain datapoints, in the other case, it allows selecting which condition should be the alarm condition.

Display of actual status

Datapoint Type	AI	AO	AV	BI	BO	BV	MI	MO	MV	PC	RI	RO
User Interface	Web Interface						CARE					
Editing	-											
Equivalent												

Displays the alarm status of the datapoint, which can be caused by faults and Off-Normal conditions.

NOTE: Multiple flag indications may be possible.

Example: A 'To-Fault transition' will always enable the 'In Alarm' flag. Hence both, the 'In Alarm' and the 'Fault' status flags are enabled.

See also "Fault" and "Out of Service" sections.

Definition of alarm condition

Datapoint Type	AI	AO	AV	BI	BO	BV	MI	MO	MV	PC	RI	RO
User Interface	Web Interface						CARE					
Editing	x						x					
Equivalent	Is in Alarm											

Defines the state which indicates and sets off an 'alarm'. If enabled, the alarm text of the corresponding transition event is displayed.

Example:

States	In Alarm	Alarm Text Display
1	NO	NO
2	YES	YES

See also "Is in Alarm" section.

Increment

Datapoint Type	AI	AO	AV	BI	BO	BV	MI	MO	MV	PC	RI	RO
User Interface	Web Interface						CARE					
Editing	x						x					
Equivalent							Change of Value Increment					

The change of value increment (COV increment) specifies the minimum change in present value that causes the controller sending the present value to recipients on the BACnet bus (e.g. Eagle Web Interface).

The COV increment is also used as the minimum change in the present value for value-based trending.

NOTE: For the pulse convertor point type, a time-based COV increment is possible.

Usage with Reference Inputs

When using reference input points which read input values, the inputs can be reside either in different plants of the same controller (internal referencing) or in plants of different controllers (external referencing).

If the reference input point reads values from an internal referencing plant, every change will be transmitted.

If the reference input point reads values from an external referencing plant, the COV increment of the source datapoints applies. Please note that in this case, the COV value must be set to appropriate (low) values in order to minimize falsification of the transmitted value.

In case the connected data point does not support COV, the poll rate set in CARE defines the interval in sec, that the reference input polls the connected data point. If the connected data point does support COV, then the poll rate has no effect. So the poll rate does not ensure a fault signal within the poll rate time when a connection is lost. In case of a loss of communication the fault flag will latest be set after 30 minutes

Initial Value

Datapoint Type	AI	AO	AV	BI	BO	BV	MI	MO	MV	PC	RI	RO
User Interface	Web Interface						CARE					
Editing							x					
Equivalent												

For reference input points, an initial value can be entered, which will be utilized at system startup if the reference input has not yet received a value from the connected point.

Input NV

Datapoint Type	AI	AO	AV	BI	BO	BV	MI	MO	MV	PC	RI	RO
User Interface	Web Interface						CARE					
Editing	-						x					
Equivalent	NV Type											

Defines the network variable type (NVT) of the Lon point in CARE, e.g. SNVT_temp for an analog input point (NV - Input).

See also "NV Type" section.

IO Configuration

Datapoint Type	AI	AO	AV	BI	BO	BV	MI	MO	MV	PC	RI	RO
User Interface	Web Interface						CARE					
Editing							x					
Equivalent												

The I/O configuration is not visible in the Eagle Web Interface, but only in CARE.

Analog input and output points must be configured prior to their assignment to a particular terminal on a module in CARE. This is done by selecting the appropriate configuration such as NTC, PT100 Type F, etc., for the datapoint. The assignment of the configuration results in the automatic setting of the configuration properties for the datapoint.

For pull-up resistor handling, please refer to the "Pull-Up Resistor Handling" section.

Is Alarm Condition

Datapoint Type	AI	AO	AV	BI	BO	BV	MI	MO	MV	PC	RI	RO
User Interface	Web Interface						CARE					
Editing	x						x					
Equivalent							In Alarm					

Defines the state which enables the 'Alarm' flag. If enabled, the alarm text of the corresponding transition event is displayed.

Example:

State Text	Is Alarm Condition	Alarm Text Display
1	NO	NO
2	YES	YES

See also "In Alarm" section.

Is Fault Condition

Datapoint Type	AI	AO	AV	BI	BO	BV	MI	MO	MV	PC	RI	RO
User Interface	Web Interface						CARE					
Editing	x						x					
Equivalent							Fault					

Defines the state which enables the 'Fault' flag. If enabled, the fault text of the corresponding transition event is displayed.

Example:

State Text	Is Fault Condition	Alarm Text Display
1	NO	NO
2	YES	YES

See also "Fault" section.

Last Transition

Datapoint Type	AI	AO	AV	BI	BO	BV	MI	MO	MV	PC	RI	RO
User Interface	Web Interface						CARE					
Editing	-											
Equivalent												

Shows the date when the last transition was performed.

LON Point

Datapoint Type	AI	AO	AV	BI	BO	BV	MI	MO	MV	PC	RI	RO
User Interface	Web Interface						CARE					
Editing	-						x					
Equivalent	Direction											

Defines in CARE if the datapoint should be mapped to a NV.

Input points can only be mapped to input NVs and output points can only be mapped to output NVs.

NOTE: If an output point is defined as "with switches", CARE will automatically map an input NV to that output point. The input NV will be used for sending the manual switch state a value from the I/O-board to the Eagle controller. The value of the manual switch is reflected at priority 1 in the priority array of the datapoint.

See also "Direction" section

Low Limit Enable

Datapoint Type	AI	AO	AV	BI	BO	BV	MI	MO	MV	PC	RI	RO
User Interface	Web Interface						CARE					
Editing	x						x					
Equivalent												

The Low Limit Enable property defines the low limit for the creation of alarms of analog points. The following conditions must be true for the system to generate an alarm:

- The present value falls below the low limit and this condition remains present for at least the defined alarm delay (time)
- Transition events 'To-OffNormal' and 'To-Normal' are enabled
- Notification class (urgent, high or low) is allocated to this point
- Notify type is set to 'Alarm' (not 'Event')

If all of these conditions are true, then an alarm of event type 'To-Off-Normal' is set off.

The Low Limit can be predefined in CARE and changed in the Eagle Web Interface later.

NOTE:

According to the BACnet standard, disabling the Low Limit only disables the reporting of the Low Limit Alarm onto the BACnet bus.

When the Low Limit is exceeded, the datapoint will still be "in Alarm", and if a BACnet front-end is polling the alarms of a BACnet controller, also datapoints with Low Limit disabled will be displayed on the BACnet front-end as being "in Alarm".

With Eagle it is possible to disable both High and Low Limit alarms at the same time, if the alarm delay time is set to 100,000 sec or longer.

Manual

Datapoint Type	AI	AO	AV	BI	BO	BV	MI	MO	MV	PC	RI	RO
User Interface	Web Interface						CARE					
Editing	x											
Equivalent												

Sets the datapoint in manual operation mode in which the present value will be overwritten with a desired value manually entered by the user.

See also "Active Text / Inactive Text" section.

Manual Life Safety

Datapoint Type	AI	AO	AV	BI	BO	BV	MI	MO	MV	PC	RI	RO
User Interface	Web Interface						CARE					
Editing	x											
Equivalent												

Shows the status of the manual override switch or potentiometer of the LON module.

Mapping

Datapoint Type	AI	AO	AV	BI	BO	BV	MI	MO	MV	PC	RI	RO
User Interface	Web Interface						CARE					
Editing	-											
Equivalent												

Shows the mapping type of a mapped datapoint. For example, if the datapoint is mapped to the present value property, PV = Present Value is displayed.

Minimum Present Value

Datapoint Type	AI	AO	AV	BI	BO	BV	MI	MO	MV	PC	RI	RO
User Interface	Web Interface						CARE					
Editing	x						x					
Equivalent												

Defines the minimum value of the graphical bar display in the EBI. Defaults to the Low Limit Reporting value.

Maximum Present Value

Datapoint Type	AI	AO	AV	BI	BO	BV	MI	MO	MV	PC	RI	RO
User Interface	Web Interface						CARE					
Editing	x						x					
Equivalent												

Defines the maximum value of the graphical bar display in the EBI. Defaults to the High Limit Reporting value.

Notification Class

Datapoint Type	AI	AO	AV	BI	BO	BV	MI	MO	MV	PC	RI	RO
User Interface	Web Interface						CARE					
Editing	x						x					
Equivalent												

The notification class can be defined and changed in CARE and in the Eagle Web Interface.

The notification class enables alarming for the datapoint by selecting a notification class with a given priority. By default, the following notification classes with descending priority can be selected:

- Urgent
- High
- Low
- Journal

These default notification classes match the default notification classes of the BACnet client.

Each recipient assigned to a notification class will receive the datapoint alarm triggered by the selected notification. But, alarms will only be generated for the enabled transitions (To-Normal, To-OffNormal, and/or To-Fault) of a recipient. Each

enabled transition will be propagated with the selected notification (see also "Alarm and Event Priority Classification" section).

This connection has not to be mixed up with the transitions selected under **Transition Events** (see "Transition Events" section).

Notify Type

Datapoint Type	AI	AO	AV	BI	BO	BV	MI	MO	MV	PC	RI	RO
User Interface	Web Interface						CARE					
Editing	-						x					
Equivalent	Alarm Type											

The notify type can be defined and changed in CARE. In the Eagle Web Interface, the notify type (alarm type) is displayed only.

For all notification classes, the notify type 'Alarm' must be used.

According to the BACnet Specification, events can be of the type 'alarm' or 'event'. On the BACnet client, alarms will be graphically indicated by blinking in the status line and shown in the alarm summary. Events will not be indicated in the status line and will be shown in the event summary.

See also "Alarm Type" section.

NV Name

Datapoint Type	AI	AO	AV	BI	BO	BV	MI	MO	MV	PC	RI	RO
User Interface	Web Interface						CARE					
Editing	-						x					
Equivalent												

Shows the name of the NV, e.g. NVInsideAirTemp that is mapped to the datapoint.

NV Type

Datapoint Type	AI	AO	AV	BI	BO	BV	MI	MO	MV	PC	RI	RO
User Interface	Web Interface						CARE					
Editing	-						x					
Equivalent							Input NV, Output NV					

Shows the type of the mapped NV, e.g. SNVT_temp.

See also "Input NV" and "Output NV" sections.

Out Of Service

Datapoint Type	AI	AO	AV	BI	BO	BV	MI	MO	MV	PC	RI	RO
User Interface	Web Interface						CARE					
Editing	x											
Equivalent												

Generates and indicates the 'out of service' status of the datapoint. The 'out of service' property allows decoupling the physical input or output from the datapoint.

For inputs the decoupling is done by manual override. For outputs this is done by checking the 'Out of Service' flag.

The 'out of service' property is suited to fix the physical input or output state, e.g. in case of maintenance checks.

In the following, the states of the 'out of service' flag/property of the various BACnet objects are listed:

AI, BI, MI

Out Of Service = unchecked:
Present value has not been overwritten

Out Of Service = checked:
Present value has been overwritten
Present value is decoupled from the physical input and will not track changes to the physical input.

AO, BO, MO

Out Of Service = checked:
Changes to the present value are decoupled from the physical output.
The present value property is still controlled by the prioritization mechanism (Priority Array, Relinquish Default)

AV, BV, MV

Out Of Service = checked:
Present value is prevented from being modified by the application.
The present value property is still controlled by the prioritization mechanism (Priority Array, Relinquish Default)

Pulse Converter

Out Of Service = unchecked:
Present value has not been overwritten

Out Of Service = checked:
Present value has been overwritten
Present value is decoupled from the Count property and will not track changes to the input.

See also "In Alarm" and "Fault" sections.

Output NV

Datapoint Type	AI	AO	AV	BI	BO	BV	MI	MO	MV	PC	RI	RO
User Interface	Web Interface						CARE					
Editing	-						x					
Equivalent	NV Type											

Defines the network variable type (NVT) of the Lon point in CARE, e.g. SNVT_lev_percent for an analog output point (NV - Output).

See also "Input NV" section.

Period

Datapoint Type	AI	AO	AV	BI	BO	BV	MI	MO	MV	PC	RI	RO
User Interface	Web Interface						CARE					
Editing	x						x					
Equivalent							COV Period					

Defines the amount of time in seconds between the periodic transmissions of the present value. This property can be used alone or in combination with the Increment property.

When the period property is used in combination with the increment property, the present value will always be updated periodically independent on the transmissions of the present value due to the COV setting.

Example:

Increment	Period	Present Value Update
0,2 K		when present value has changed by 0,2 K or more
	3 s	every 3 s
0,2 K	3 s	every 3 s and when present value has changed by 0,2 K or more

Priority Level

Datapoint Type	AI	AO	AV	BI	BO	BV	MI	MO	MV	PC	RI	RO
User Interface	Web Interface						CARE					
Editing	-											
Equivalent												

The value of the present value is controlled by a command prioritization mechanism which is based upon a fixed number of priorities that are assigned to command – issuing entities (BACnet tasks, control strategy, time program, and manual operator inputs). Each of these entities writes to the present value with its assigned priority level. The number of priorities is arranged in a priority list of descending priority.

Example:

	Priority Level	Value
1	Manual Life Safety	-
2		-
3		-
4		-
5	Critical Equipment Control	19,5 °C
6	Minimum On Off	
7		
8	Manual Operator	21,0 °C
9		-
10		-
11		-
12		-
13		-
14		-
15	Control Program	-
16		-
	Relinquish Default	20,0 °C

The priority list can include max. 16 values and will be continuously updated by written values caused by the command-issuing entities.

The value of the highest priority level is always written to the present value as long as the priority list is not empty. If the list is empty, the user-definable relinquish default value is written to the present value.

For the example in the table, Critical Equipment Control has the highest priority and is written to the present value. As soon as the priorities 5 and 8 are relinquished e.g. via BACnet service, the relinquish default of 20,0°C will be valid for the present value.

Polarity

Datapoint Type	AI	AO	AV	BI	BO	BV	MI	MO	MV	PC	RI	RO
User Interface	Web Interface						CARE					
Editing	-						x					
Equivalent												

The polarity indicates the relationship between the physical state of the input and the logical state represented by the present value. If the polarity is NORMAL, then the ACTIVE state of the present value is also the ACTIVE or ON state of the physical input. If the polarity is REVERSE, then the ACTIVE state of the present value is the INACTIVE or OFF state of the physical Input.

Polarity	Present Value	Physical State of Input	Physical State of Device
NORMAL	INACTIVE	OFF or INACTIVE	<u>not</u> running
NORMAL	ACTIVE	ON or ACTIVE	running
REVERSE	INACTIVE	ON or ACTIVE	<u>not</u> running
REVERSE	ACTIVE	OFF or INACTIVE	running

Property

Datapoint Type	AI	AO	AV	BI	BO	BV	MI	MO	MV	PC	RI	RO
User Interface	Web Interface						CARE					
Editing							-					
Equivalent												

By default, the present value is selected as property of a reference input point in CARE.

Read Access Level

Datapoint Type	AI	AO	AV	BI	BO	BV	MI	MO	MV	PC	RI	RO
User Interface	Web Interface						CARE					
Editing	-						x					
Equivalent												

The read access level can be defined and changed in CARE only. In the Eagle Web Interface, the read access level is displayed only.

The read access level assigned to a datapoint determines which user level can read values (properties) of that particular datapoint on the Eagle Web Interface.

A user who has a user level equal to or higher than the assigned read access level of the datapoint, will have this access right enabled in the Eagle Web Interface, all others will not (for further details, please refer to the User Administration section).

Reference

Datapoint Type	AI	AO	AV	BI	BO	BV	MI	MO	MV	PC	RI	RO
User Interface	Web Interface						CARE					
Editing							x					
Equivalent												

The reference property of a reference input point provides the source (BACnet object) which passes the value to the reference input point. The reference property of a reference output point provides the source (BACnet object) which passes the value to the reference output point.

Sources can be any point of any Eagle controller and 3rd-party BACnet device of the project.

Reference Points

Reference points are a type of software point that can share point information across plants. If plants are located in different controllers, the point information will be automatically transferred across the BACnet bus.

Reference Input Points

Reference input points receive information from a point in another plant of the same controller (internal reference) or of another plant in another controller or 3rd - party device (external reference). Controllers and 3rd - party devices can reside in the same or in different projects (for detailed procedure see CARE User Guide EN2Z-0970GE51).

Each reference input is associated with a physical or value datapoint (source point) somewhere in a plant residing in a controller on the bus. The source point cannot be a receiver point and source point and receiver point cannot reside in the same plant.

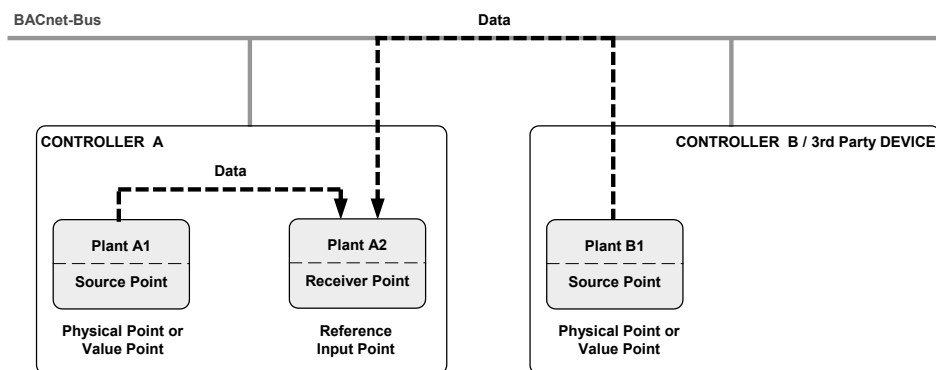

NOTE: Controllers / 3rd Pary Devices can be in the same or in different projects.

Fig. 7. Data exchange between plants via reference input points

Reference Input Point Operation

If the reference input point reads values from an internal referencing plant, every change will be transmitted.

If the reference input point reads values from an external referencing plant, the COV increment of the source datapoints applies. Please note, that in this case, the COV value must be set to appropriate (low) values in order to minimize falsification of the transmitted value.

In case the connected data point does not support COV, the poll rate set in CARE defines the interval in sec, that the reference input polls the connected data point. If the connected data point does support COV, then the poll rate has no effect. So the poll rate does not ensure a fault signal within the poll rate time when a connection is lost. In case of a loss of communication the fault flag will latest be set after 30 minutes

See also "Input NV", "Output NV" and "Remote Status Flags" sections.

Reliability

Datapoint Type	AI	AO	AV	BI	BO	BV	MI	MO	MV	PC	RI	RO
User Interface	Web Interface											
Editing	-											
Equivalent												

Shows whether the hardware assigned to the datapoint is in proper condition or not. Depending on the datapoint type, the following conditions may be displayed:

No Error Detected	Loop is in proper condition, that is, present value is reliable; that is, no other fault has been detected.
No Sensor	Sensor may be not connected
No Output	Hardware may be not connected
Unreliable Other	The controller has detected that the present value is unreliable, but none of the other conditions describe the nature of the problem. A generic fault other than those listed above has been detected, e.g., a Binary Input is not cycling as expected.

NOTE: For binary output datapoints, the reliability will work only if the service type of the corresponding NVo in CARE is set to 'acknowledged'.

Relinquish Default

Datapoint Type	AI	AO	AV	BI	BO	BV	MI	MO	MV	PC	RI	RO
User Interface	Web Interface						CARE					
Editing	x						x					
Equivalent												

Defines the value that will be written to the present value, if the priority list is empty which means that no other value is present in the priority list. The relinquish default value allows starting up a control system with a defined status/value. The relinquish default value is predefined in the application in CARE and can be changed in the Eagle Web Interface.

For further information on priority levels and command priorities, please refer to the "Priority Level" section.

Relinquish Priority

Datapoint Type	AI	AO	AV	BI	BO	BV	MI	MO	MV	PC	RI	RO
User Interface	Web Interface						CARE					
Editing							x					
Equivalent												

This is a property which can be only accessed via the CARE control loop editor. The property allows relinquishing a certain priority level. It is written on each execution of the RACL loop. If it is not required to relinquish a datapoint, a number higher than 17 need to be written on this property.

Example: To bring a datapoint from manual to auto mode, 8 needs to be written on the Relinquish Priority property (see figure on next page).

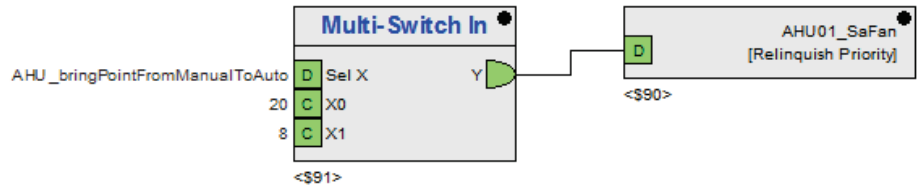

For further information on priority levels and command priorities, please refer to the "Priority Level" section.

Remote Status Flags

Datapoint Type	AI	AO	AV	BI	BO	BV	MI	MO	MV	PC	RI	RO
User Interface	Web Interface						CARE					
Editing							x					
Equivalent												

Reads the status flags from remote devices using a reference input in order to use the status flag information in the application. The property can be read via BACnet and in DDC programs.

The status flag information is coded as a BitString with 4 bits (0..3). The status flags are read as follows:

- in alarm (bit 0)
- in fault (bit 1)
- overridden (bit 2)
- out of service (bit 3)

Reporting

Datapoint Type	AI	AO	AV	BI	BO	BV	MI	MO	MV	PC	RI	RO
User Interface	Web Interface						CARE					
Editing	x						x					
Equivalent							Transition Events					

Defines, which transition type will be reported, that is, which transition should be saved in the alarm buffer and in the alarm list in the Web Interface.

See also "Transition Events" section.

Reset to

Datapoint Type	AI	AO	AV	BI	BO	BV	MI	MO	MV	PC	RI	RO
User Interface	Web Interface						CARE					
Editing	x											
Equivalent												

Resets the current value to a specific value for a:

- pulse converter
- runtime counter of a binary output
- state counter of a binary point

The counting will restart.

Change of State Count

Datapoint Type	AI	AO	AV	BI	BO	BV	MI	MO	MV	PC	RI	RO
User Interface	Web Interface						CARE					
Editing	-											
Equivalent												

Displays the number of state changes of the binary datapoint.

Resolution

Datapoint Type	AI	AO	AV	BI	BO	BV	MI	MO	MV	PC	RI	RO
User Interface	Web Interface						CARE					
Editing	-											
Equivalent												

Shows the resolution which defines the smallest recognizable change of the present value. The smaller the value the more precise a value change can be recognized.

Runtime (Active Time)

Datapoint Type	AI	AO	AV	BI	BO	BV	MI	MO	MV	PC	RI	RO
User Interface	Web Interface						CARE					
Editing	"Reset to"											
Equivalent												

Shows the runtime of the connected device. The runtime (active time) can be changed by reset.

The runtime can be reported as follows:

In CARE, use the IDT statement to read the 'Elapsed Active Time' property of a datapoint. Compare this value to a limit value and use an additional point to report an alarm.

Safety Position

Datapoint Type	AI	AO	AV	BI	BO	BV	MI	MO	MV	PC	RI	RO
User Interface	Web Interface						CARE					
Editing	x						x					
Equivalent							Communication Failure					

In case of communication failure or application stop, the device is commanded to one of the following positions if the controller does not deliver a value (no response):

Analog Output:

- 0 %
 - 50 %
 - 100 %
- device is commanded to the selected percentage value

Binary Output:

- OFF (logical)
- ON (logical)

device is commanded to the selected logical state (name depends on state texts definition)

- Remain in current position
device is commanded to the last valid position

NOTE:
For analog outputs, the safety position is affected by the characteristic used for the controller modules. For particular characteristics there is no linear correlation between percentage value and voltage output:

DP Type	Listbox number	Characteristic	Safety position (%)	
			0 50 100	
			in DP values	in Volts
AO	1..10	User defined		0 5 10
AO	9	0-100%=2-10V	-25 37.5 100	0 5 10
AO	10	100-0%=2-10V	125 62.5 0	0 5 10
AO	12	LINEAR GRAPH	0 50 100	0 5 10
AO	24	0-10V=0-100%	0 50 100	0 5 10
AO	25	2-10V=0-100%	0 50 100	2 6 10
DO	--	DO on AO	OFF / ON	0 10
MOT	12	LINEAR GRAPH	0 50 100	0 5 10

NOTE: The user-defined characteristics 1 through 10 can be changed; in this context, characteristics 3, 4, 5, 6, 9, 10 are pre-defined by CARE (default characteristics) and characteristics 1 and 2 are not pre-defined. The default characteristics 3 through 6 are pressure input characteristics which should not be used for an analog output.

In general, for the user-defined characteristics 1 through 10, the safety positions 0%, 50%, 100% do always mean 0V, 5V, 10V; in this context the datapoint values for characteristics 9 and 10 are deviant.

Safety Value

Datapoint Type	AI	AO	AV	BI	BO	BV	MI	MO	MV	PC	RI	RO
User Interface	Web Interface						CARE					
Editing	-						x					
Equivalent							Communication Failure					

In case of communication failure or application stop, the device is commanded to one of the following positions if the controller does not deliver a value (no response):

- Last Valid Value
device is commanded to the last valid position
- Safety Value
device is commanded to the value entered in Safety Value (CARE)

Scaling Factor

Datapoint Type	AI	AO	AV	BI	BO	BV	MI	MO	MV	PC	RI	RO
User Interface	Web Interface						CARE					
Editing							x					
Equivalent												

Input pulses from utility meters (gas, water, heat, etc.) transmitted via LonWorks can be connected to pulse converter inputs using the property "Scaling Factor". The pulses supplied by the meters are multiplied by the scaling factor and are then ready to be read as pure consumption values. The "Scaling Factor" thus always indicates the value of each pulse received.

The adjustable range is 0.0 through 100,000,000.0,

The number of decimal places depends on the selected engineering unit.

Example: A heat meter supplies 10 pulses per kWh "consumed". Accordingly, the scaling factor (= value of a pulse) is 0.1 kWh/pulse.

Sensor Offset

Datapoint Type	AI	AO	AV	BI	BO	BV	MI	MO	MV	PC	RI	RO
User Interface	Web Interface						CARE					
Editing	x						x					
Equivalent												

The sensor offset applies only for analog input datapoints connected to panel bus or onboard IO's. It allows shifting the value.

The adjustable range is -100,000,000.0 through 100,000,000.0

It is entered in the engineering unit of the datapoints.

If the datapoint is in fault state the sensor offset is not added to the datapoint.

Time to Close

Datapoint Type	AI	AO	AV	BI	BO	BV	MI	MO	MV	PC	RI	RO
User Interface	Web Interface						CARE					
Editing	x						x					
Equivalent												

Defines the time in sec the motor should need to close the controlled device when using a 3 Position Output

Time to Open

Datapoint Type	AI	AO	AV	BI	BO	BV	MI	MO	MV	PC	RI	RO
User Interface	Web Interface						CARE					
Editing	x						x					
Equivalent												

Defines the time in sec the motor should need to open the controlled device when using a 3 Position Output

State Text

Datapoint Type	AI	AO	AV	BI	BO	BV	MI	MO	MV	PC	RI	RO
User Interface	Web Interface						CARE					
Editing	-						x					
Equivalent							State Texts					

Multistate datapoints allow switching 256 states (stages) including the "off stage" of physical digital inputs or outputs. For each state, a state text can be created and assigned to the point in CARE. The state text is displayed on the Eagle Web Interface when the point switches the input or output to the corresponding state (stage).

Example: Multi-stage fan with state texts: stage 1, stage 2, stage 3, etc.

States

See "#States and State Text" sections.

#States

Datapoint Type	AI	AO	AV	BI	BO	BV	MI	MO	MV	PC	RI	RO
User Interface	Web Interface						CARE					
Editing	-						x					
Equivalent							States					

Shows the number of states of a multi-state datapoint.

Time Delay

Datapoint Type	AI	AO	AV	BI	BO	BV	MI	MO	MV	PC	RI	RO
User Interface	Web Interface						CARE					
Editing	x						x					
Equivalent							Alarm Delay					

The time delay determines how long a 'To-Off-Normal' or a 'Back-To-Normal' transition must exist before an event enrollment alarm is sent to the recipient. Entering a time delay of 10 seconds means that the limit value must be exceeded for at least 10 seconds before this event enrollment sends an event notification to the recipient. If the limit value only lasts for 7 seconds, then no event notification is sent.

Time of Last Reset

Datapoint Type	AI	AO	AV	BI	BO	BV	MI	MO	MV	PC	RI	RO
User Interface	Web Interface						CARE					
Editing	-											
Equivalent												

Shows the time of the last reset of a binary output or pulse converter datapoint.

Time of State Count Reset

Datapoint Type	AI	AO	AV	BI	BO	BV	MI	MO	MV	PC	RI	RO
User Interface	Web Interface						CARE					
Editing	x/-											
Equivalent												

Shows the time of the last state counter reset for the binary datapoint.

Transition Events

Datapoint Type	AI	AO	AV	BI	BO	BV	MI	MO	MV	PC	RI	RO
User Interface	Web Interface						CARE					
Editing	<i>"see Reporting"</i>						x					
Equivalent	Event											

Defines which transition type (To-Off-Normal, Back To-Normal, and/or To Fault) will be reported and tracked by time stamping. The timestamps can be seen in the Eagle Web Interface.

See also "Event" and "Reporting" sections.

Type

Datapoint Type	AI	AO	AV	BI	BO	BV	MI	MO	MV	PC	RI	RO
User Interface	Web Interface						CARE					
Editing	-											
Equivalent												

Shows the datapoint type, e.g. analog input, digital output, etc.

Use as Setpoint

Datapoint Type	AI	AO	AV	BI	BO	BV	MI	MO	MV	PC	RI	RO
User Interface	HTML Interface						CARE					
Editing	X						X					
Equivalent												

If in CARE this property is set for a datapoint, the **Use as Setpoint** field will be displayed in the HTML Interface and on the controller HMI for overwriting the present value without the necessity of setting the datapoint into manual mode before. Instead, the present value can be overwritten quickly by entering the value in the **Use as Setpoint** field displayed in the corresponding interface.

NOTE: The field will not be available in the HTML Interface and on the controller HMI if the property is not enabled in CARE.

With Switches / 3 Position Output

Datapoint Type	AI	AO	AV	BI	BO	BV	MI	MO	MV	PC	RI	RO
User Interface	Web Interface						CARE					
Editing							x					
Equivalent												

The With Switches / 3 Position Output options are not visible in the Eagle Web Interface, but only in CARE.

Defines whether the point transmits a continuous signal and is on a board with switches (AO, BO), or if the point is a 3 position output (AO).

Write Access Level

Datapoint Type	AI	AO	AV	BI	BO	BV	MI	MO	MV	PC	RI	RO
User Interface	Web Interface						CARE					
Editing	-						x					
Equivalent												

The write access level can be defined and changed in CARE only. In the Eagle Web Interface, the write access level is displayed only.

The write access level assigned to a datapoint determines which user level can write values (properties) to that particular datapoint on the Eagle Web Interface.

A user who has a user level equal to or higher than the assigned write access level of the datapoint, will have this access right enabled in the Eagle Web Interface, all others will not (for further details, please refer to the User Administration section).

Datapoint Properties Overview

Each point in a controller has associated properties such as datapoint name, notification class and descriptor. Point properties may not be available for editing in BACnet front-ends such as the Central (BACnet client), or in the Eagle Web Interface. Contrariwise in CARE, some online properties such as present value, statuses, etc. are not available in principle.

This chapter contains tables for each point type. The tables list point properties and presents the following information for each:

- **Property denotation** specifies either the attribute name in the related CARE *Datapoint Properties* tab and/or in the Eagle *Datapoint Details* tabs.
- Whether or not the property is available for **off-line editing**. “Off-line” editing refers to changes made to database values while the controller is not active in the system. In other words, when you are using CARE to change copies of controller files, not the files in the actual controller.
- Whether or not the attribute is available for **on-line editing**. “On-line” editing refers to changes made to controller files while the controller is active. For example, if you are using the Eagle Web Interface or a BACnet client to change field values in a controller while it is operating.

Analog Input

Property Denotation			Online-Editing		Offline-Editing
Eagle Web Interface	CARE	BACnet	Eagle Web Interface	BACnet	CARE
"Datapoint name displayed in title line of dialog"	Datapoint Name		-		+
GENERAL					
Type (Type/Inst.)	"n.a."		-		-
Description	Descriptor	description	-	+	+
Mapping	"n.a."		-		-
Name / NV Name	"automatically generated by CARE"		-		-
Type / NV type			-		+
Direction	Input or output (NV) and hardware source (onboard, panel, Lon)		-		+
Read access level	Read access level		-		+
Write access level	Write access level		-		+
ALARMING					
Notification class	Notification class	notification-class	+	+	+
Notify type	Notify type	notify-type	-	+	+
Event: To Off-Normal, To Fault, Back to Normal "selectable under Reporting, see Reporting"	Reporting: To Off-Normal, To Fault, Back to Normal		+		+
Reporting	Reporting	event-enable	+	+	+
Acknowledged)	"n.a."		-		-
Last transition	"n.a."		-		-
High limit enable	High limit Reporting	high-enable	+	+	+
Low limit enable	Low limit Reporting	low-enable	+	+	+
Deadband	Deadband	deadband	+	+	+
Suppress alarm	"n.a."		+		-
Alarm delay	Alarm delay	time-delay	+	+	+
Suppress alarm	"n.a."		+		-
VALUES					
Auto, Manual	"n.a."		+		-
Minimum Present Value	Min Present Value	min-pres-value	-	+	+
Maximum Present Value	Max Present Value	max-pres-value	-	+	+
Characteristic	Characteristic		-		+
Resolution	"n.a."		-		-
Reliability	"n.a."		-		-
Safety Value	Communication Failure		-		+
Sensor offset	Sensor offset		+		+
In alarm	"n.a."		-		-
Fault	"n.a."		-		-
Overridden	"n.a."		-		-
Out of Service	"n.a."		-		-
Increment	Change of value increment	cov-increment	+	+	+
Alarm text, "displayed in alarm buffer"	Alarm text		-		+
"assigned to value"	Engineering unit		-		+
"n.a."	IO Configuration		-		+
"n.a."	Point role (EDK)		-		+

Property Denotation			Online-Editing		Offline-Editing
Eagle Web Interface	CARE	BACnet	Eagle Web Interface	BACnet	CARE
"n.a."	BACnet Object Type		-		-
"n.a."	BACnet Object ID		-		-
"n.a."	BACnet Object Instance Number		-		-
EVENT ENROLLMENTS	EVENT ENROLLMENTS		+		+
Name	Name		-		+
Description	Description		-		+
Event type	Event type		-		-
High Limit	High Warning Limit		+		+
Low Limit	Low Warning Limit		+		+
Deadband	Deadband		+		+
Bit Mask, Bit String(s)	Status Flags		-		+
Bit Mask, Bit String(s)	Event Parameters		-		+
Bit String(s)	List of Values		-		-
Time delay	Alarm delay		+		+
Notify type	Notify type		-		+
Notification class	Notification class		-		+
Event: To Off-Normal, To Fault, Back to Normal <i>"selectable under Reporting, see Reporting"</i>	Reporting: To Off-Normal, To Fault, Back to Normal		+		+
Reporting	Reporting		+		+
Acknowledged)	"n.a."		+		-
Last transition	"n.a."		-		-
"n.a."	BACnet object ID		-		-
Event state	"n.a."		-		-
Object type	"n.a."		-		-
Read access level	Read access level		-		+
Write access level	Write access level		-		+

NOTE: Comments are written in *italic* and in "quotation marks"

Analog Output

Property Denotation			Online-Editing		Offline-Editing
Eagle Web Interface	CARE	BACnet	Eagle Web Interface	BACnet	CARE
"Datapoint name displayed in title line of dialog"	Datapoint Name		-		+
GENERAL					
Type (Type/Inst.)	"n.a."		-		-
Description	Descriptor	description	-	+	+
Mapping	"n.a."		-		-
Name / NV Name	"automatically generated by CARE"		-		-
Type / NV type			-		+
Direction	Input or output (NV) and hardware source (onboard, panel, Lon)		-		+
Read access level	Read access level		-		+
Write access level	Write access level		-		+
ALARMING					
Notification class	Notification class		-		+
Notify type	Notify type	notification-class	-	+	+
Event: To Off-Normal, To Fault, Back to Normal "selectable under Reporting, see Reporting"	Reporting: To Off-Normal, To Fault, Back to Normal	notify-type	+	+	+
Reporting	Reporting		+		+
Acknowledged)	"n.a."	event-enable	-	+	-
Last transition	"n.a."		-		-
High limit enable	High limit Reporting		+		+
Low limit enable	Low limit Reporting	high-enable	+	+	+
Deadband	Deadband	low-enable	+	+	+
Suppress alarm	"n.a."		+		-
Alarm delay	Alarm delay	deadband	+	+	+
		time-delay		+	
VALUES					
Auto, Manual	"n.a."		+		-
Minimum Present Value	Min Present Value		-		+
Maximum Present Value	Max Present Value	min-pres-value	-	+	+
Manual Life Safety	"n.a."	max-pres-value	-	+	-
Resolution	"n.a."		-		-
Reliability	"n.a."		-		-
Direct / Reverse	Direct / Reverse		+		+
Safety Position	Communication Failure		+		+
In alarm	"n.a."		-		-
Fault	"n.a."		-		-
Overridden	"n.a."		-		-
Out of Service	"n.a."		-		-
Increment	Change of value increment	cov-increment	+	+	+
COMMAND PRIORITIES					
Relinquish default	Relinquish default	relinquish-default	+	+	+

Property Denotation			Online-Editing		Offline-Editing
Eagle Web Interface	CARE	BACnet	Eagle Web Interface	BACnet	CARE
Alarm text, <i>“displayed in alarm buffer”</i>	Alarm text		-		+
<i>“assigned to value”</i>	Engineering unit		-		+
<i>“n.a.”</i>	IO Configuration		-		+
<i>“n.a.”</i>	Characteristic		-		+
<i>“n.a.”</i>	Point role (EDK)		-		+
<i>“n.a.”</i>	With Switches		-		+
<i>“n.a.”</i>	3 Position Output		-		+
<i>“n.a.”</i>	BACnet Object Type		-		-
<i>“n.a.”</i>	BACnet Object ID		-		-
<i>“n.a.”</i>	BACnet Object Instance Number		-		-
EVENT ENROLLMENTS					
EVENT ENROLLMENTS	EVENT ENROLLMENTS		+		+
Name	Name		-		+
Description	Description		-		+
Event type	Event type		-		-
High Limit	High Warning Limit		+		+
Low Limit	Low Warning Limit		+		+
Deadband	Deadband		+		+
Bit Mask, Bit String(s)	Status Flags		-		+
Bit Mask, Bit String(s)	Event Parameters		-		+
Bit String(s)	List of Values		-		-
Time delay	Alarm delay		+		+
Notify type	Notify type		-		+
Notification class	Notification class		-		+
Event: To Off-Normal, To Fault, Back to Normal <i>“selectable under Reporting, see Reporting”</i>	Reporting: To Off-Normal, To Fault, Back to Normal		+		+
Reporting	Reporting		+		+
Acknowledged)	<i>“n.a.”</i>		+		-
Last transition	<i>“n.a.”</i>		-		-
<i>“n.a.”</i>	BACnet object ID		-		-
Event state	<i>“n.a.”</i>		-		-
Object type	<i>“n.a.”</i>		-		-
Read access level	Read access level		-		+
Write access level	Write access level		-		+

NOTE: Comments are written in *italic* and in “quotation marks”

Analog Value

Property Denotation			Online-Editing		Offline-Editing
Eagle Web Interface	CARE	BACnet	Eagle Web Interface	BACnet	CARE
"Datapoint name displayed in title line of dialog"	Datapoint Name		-		+
GENERAL					
Type (Type/Inst.)	"n.a."		-		-
Description	Descriptor	description	-	+	+
Read access level	Read access level		-		+
Write access level	Write access level		-		+
ALARMING					
Notification class	Notification class	notification-class	+	+	+
Notify type	Notify type	notify-type	-	+	+
Event: To Off-Normal, To Fault, Back to Normal "selectable under Reporting, see Reporting"	Reporting: To Off-Normal, To Fault, Back to Normal		+		+
Reporting	Reporting	event-enable	+	+	+
Acknowledged)	"n.a."		-		-
Last transition	"n.a."		-		-
High limit enable	High limit Reporting	high-enable	+	+	+
Low limit enable	Low limit Reporting	low-enable	+	+	+
Deadband	Deadband	deadband	+	+	+
Suppress alarm	"n.a."		+		-
Alarm delay	Alarm delay	time-delay	+	+	+
VALUES					
Auto, Manual	"n.a."		+		-
Use as setpoint	Setpoint		-	-	+
Manual Life Safety	"n.a."		-		-
Reliability	"n.a."		-		-
EOH/EOV Optimization	EOH/EOV Optimization		+		+
In alarm	"n.a."		-		-
Fault	"n.a."		-		-
Overridden	"n.a."		-		-
Out of Service	"n.a."		-		-
Increment	Change of value increment	cov-increment	+	+	+
COMMAND PRIORITIES					
Relinquish default	Relinquish default	relinquish-default	+	+	+
Alarm text, "displayed in alarm buffer"					
"assigned to value"	Alarm text		-		+
"n.a."	Engineering unit		-		+
"n.a."	Point role (EDK)		-		+
"n.a."	BACnet Object Type		-		-
"n.a."	BACnet Object ID		-		-
"n.a."	BACnet Object Instance Number		-		-
EVENT ENROLLMENTS					
Name	EVENT ENROLLMENTS		+		+
Name	Name		-		+

Property Denotation			Online-Editing		Offline-Editing
Eagle Web Interface	CARE	BACnet	Eagle Web Interface	BACnet	CARE
Description	Description		-		+
Event type	Event type		-		-
High Limit	High Warning Limit		+		+
Low Limit	Low Warning Limit		+		+
Deadband	Deadband		+		+
Bit Mask, Bit String(s)	Status Flags		-		+
Bit Mask, Bit String(s)	Event Parameters		-		+
Bit String(s)	List of Values		-		-
Time delay	Alarm delay		+		+
Notify type	Notify type		-		+
Notification class	Notification class		-		+
Event: To Off-Normal, To Fault, Back to Normal " <i>selectable</i> <i>under Reporting, see</i> <i>Reporting</i> "	Reporting: To Off-Normal, To Fault, Back to Normal		+		+
Reporting	Reporting		+		+
Acknowledged)	"n.a."		+		-
Last transition	"n.a."		-		-
"n.a."	BACnet object ID		-		-
Event state	"n.a."		-		-
Object type	"n.a."		-		-
Read access level	Read access level		-		+
Write access level	Write access level		-		+

NOTE: Comments are written in *italic* and in "quotation marks"

Binary Input

Property Denotation			Online-Editing		Offline-Editing
Eagle Web Interface	CARE	BACnet	Eagle Web Interface	BACnet	CARE
"Datapoint name displayed in title line of dialog"	Datapoint Name		-		+
GENERAL					
Type (Type/Inst.)	"n.a."		-		-
Description	Descriptor	description	-	+	+
Mapping	"n.a."		-		-
Name / NV Name	"automatically generated by CARE"		-		-
Type / NV type			-		+
Direction	Input or output (NV) and hardware source (onboard, panel, Lon)		-		+
Read access level	Read access level		-		+
Write access level	Write access level		-		+
ALARMING					
Notification class	Notification class	notification-class	+	+	+
Notify type	Notify type	notify-type	-	+	+
Event: To Off-Normal, To Fault, Back to Normal "selectable under Reporting, see Reporting"	Reporting: To Off-Normal, To Fault, Back to Normal		+		+
Reporting	Reporting	event-enable	+	+	+
Acknowledged)	"n.a."		-		-
Last transition	"n.a."		-		-
Alarm value enable	Alarm value	alarm-value	+	+	+
Suppress alarm			+		-
Alarm delay	Alarm delay	time-delay	+	+	+
VALUES					
Auto, Manual Active / Inactive Text	"n.a."		+		-
Reliability	"n.a."		-		-
Change of State Time	"n.a."		-		-
Polarity	Polarity		-		+
In alarm	"n.a."		-		-
Fault	"n.a."		-		-
Overridden	"n.a."		-		-
Out of Service	"n.a."		-		-
"n.a." "n.a." "n.a."	Change of State Count Reset to Time of State Count Reset		- + -		- - -
"n.a." "n.a." "n.a."	Runtime (active time) Reset to Time of last reset		- + -		- - -
Alarm text, "displayed in alarm buffer"	Alarm text		-		+
"assigned to value"	Engineering unit		-		+
"n.a."	Point role (EDK)		-		+
"n.a."	BACnet Object Type		-		-

Property Denotation			Online-Editing		Offline-Editing
Eagle Web Interface	CARE	BACnet	Eagle Web Interface	BACnet	CARE
"n.a."	BACnet Object ID		-		-
"n.a."	BACnet Object Instance Number		-		-
EVENT ENROLLMENTS	EVENT ENROLLMENTS		+		+
Name	Name		-		+
Description	Description		-		+
Event type	Event type		-		-
High Limit	High Warning Limit		X		X
Low Limit	Low Warning Limit		X		X
Bit Mask, Bit String(s)	Status Flags		-		X
Bit Mask, Bit String(s)	Event Parameters		-		X
Bit String(s)	List of Values		-		-
Time delay	Alarm delay		X		X
Notify type	Notify type		-		X
Notification class	Notification class		-		X
Event: To Off-Normal, To Fault, Back to Normal <i>"selectable under Reporting, see Reporting"</i>	Reporting: To Off-Normal, To Fault, Back to Normal		+		+
Reporting	Reporting		+		+
Ackn(owledged)	"n.a."		+		-
Last transition	"n.a."		-		-
"n.a."	BACnet object ID		-		-
Event state	"n.a."		-		-
Object type	"n.a."		-		-
Read access level	Read access level		-		+
Write access level	Write access level		-		+

NOTE: Comments are written in *italic* and in "quotation marks"

Binary Output

Property Denotation			Online-Editing		Offline-Editing
Eagle Web Interface	CARE	BACnet	Eagle Web Interface	BACnet	CARE
"Datapoint name displayed in title line of dialog"	Datapoint Name				+
GENERAL					
Type (Type/Inst.)	"n.a."		-		-
Description	Descriptor	description	-	+	+
Mapping	"n.a."		-		-
Name / NV Name	"automatically generated by CARE"		-		-
Type / NV type			-		+
Direction	Input or output (NV) and hardware source (onboard, panel, Lon)		-		+
Read access level	Read access level		-		+
Write access level	Write access level		-		+
			-		
ALARMING			-		
Notification class	Notification class	notification-class	+	+	+
Notify type	Notify type	notify-type	-	+	+
Event: To Off-Normal, To Fault, Back to Normal "selectable under Reporting, see Reporting"	Reporting: To Off-Normal, To Fault, Back to Normal		-		+
Reporting	Reporting	event-state	-	+	+
Acknowledged)	"n.a."				-
Last transition	"n.a."				-
VALUES			+		
Auto, Manual Active / Inactive Text	"n.a."		+		-
Manual Life Safety	"n.a."		-		-
Reliability	"n.a."		-		-
Feedback Point	Feedback point		-	-	+
Change of State Time	"n.a."		-		-
Polarity	Polarity		-		+
Safety Position	Communication Failure		+		+
In alarm	"n.a."				-
Fault	"n.a."				-
Overridden	"n.a."		+		-
Out of Service	"n.a."		-		-
"n.a." "n.a." "n.a."	Change of State Count Reset to Time of State Count Reset		- + -		- - -
"n.a." "n.a." "n.a."	Runtime (active time) Reset to Time of last reset		- - -		- - -
			-		
COMMAND PRIORITIES			-		
Relinquish default	Relinquish default	Relinquish-default	-	+	+

Property Denotation			Online-Editing		Offline-Editing
Eagle Web Interface	CARE	BACnet	Eagle Web Interface	BACnet	CARE
Alarm text, <i>"displayed in alarm buffer"</i>	Alarm text		- + -		+
<i>"assigned to value"</i>	Engineering unit				+
<i>"n.a."</i>	Point role (EDK)				+
<i>"n.a."</i>	BACnet Object Type		+		-
<i>"n.a."</i>	BACnet Object ID				-
<i>"n.a."</i>	BACnet Object Instance Number				-
			-		
EVENT ENROLLMENTS	EVENT ENROLLMENTS		-		+
Name	Name		-		+
Description	Description		-		+
Event type	Event type		-		-
High Limit	High Warning Limit		-		+
Low Limit	Low Warning Limit				+
Bit Mask, Bit String(s)	Status Flags		+		+
Bit Mask, Bit String(s)	Event Parameters		-		+
Bit String(s)	List of Values		-		-
Time delay	Alarm delay		-		+
Notify type	Notify type		+		+
Notification class	Notification class		-		+
Event: To Off-Normal, To Fault, Back to Normal <i>"selectable under Reporting, see Reporting"</i>	Reporting: To Off-Normal, To Fault, Back to Normal		-		+
Reporting	Reporting		-		+
Acknowledged)	<i>"n.a."</i>		-		-
Last transition	<i>"n.a."</i>		+		-
<i>"n.a."</i>	BACnet object ID		-		-
Event state	<i>"n.a."</i>		-		-
Object type	<i>"n.a."</i>		+		-
Read access level	Read access level		+		+
Write access level	Write access level		+		+

NOTE: Comments are written in *italic* and in "quotation marks"

Binary Value

Property Denotation			Online-Editing		Offline-Editing
Eagle Web Interface	CARE	BACnet	Eagle Web Interface	BACnet	CARE
"Datapoint name displayed in title line of dialog"	Datapoint Name		-		+
GENERAL					
Type (Type/Inst.)	"n.a."		-		-
Description	Descriptor	description	-	+	+
Read access level	Read access level		-		+
Write access level	Write access level		-		+
ALARMING					
Notification class	Notification class	notification-class	+	+	+
Notify type	Notify type	notify-type	+	+	+
Event: To Off-Normal, To Fault, Back to Normal "selectable under Reporting, see Reporting"	Reporting: To Off-Normal, To Fault, Back to Normal		+		+
Reporting	Reporting	event-enable	+	+	+
Acknowledged)	"n.a."		-		-
Last transition	"n.a."		-		-
Alarm value	Alarm value enable		+		+
Suppress alarm					
Alarm delay	Alarm delay	time delay	+	+	+
VALUES					
Auto, Manual Active / Inactive Text	"n.a."		+		-
Use as setpoint	Setpoint		-	-	+
Manual Life Safety	"n.a."		-		-
Reliability	"n.a."		-		-
Change of State Time	"n.a."		-		-
EOH/EOV Optimization	EOH/EOV Optimization		+		+
"n.a." "n.a." "n.a."	Change of State Count Reset to Time of State Count Reset		- + -		- - -
"n.a." "n.a." "n.a."	Runtime (active time) Reset to Time of last reset		- - -		- - -
In alarm	"n.a."		-		-
Fault	"n.a."		-		-
Overridden	"n.a."		-		-
Out of Service	"n.a."		-		-
COMMAND PRIORITIES					
Relinquish default	Relinquish default	Relinquish-default	+	+	+
Alarm text, "displayed in alarm buffer"	Alarm text		-		+
"assigned to value"	Engineering unit		-		+
"n.a."	Point role (EDK)		-		+
"n.a."	BACnet Object Type		-		-
"n.a."	BACnet Object ID		-		-
"n.a."	BACnet Object		-		-

Property Denotation			Online-Editing		Offline-Editing
Eagle Web Interface	CARE	BACnet	Eagle Web Interface	BACnet	CARE
	Instance				
EVENT ENROLLMENTS	EVENT ENROLLMENTS		+		+
Name	Name		-		+
Description	Description		-		+
Event type	Event type		-		-
High Limit	High Warning Limit		+		+
Low Limit	Low Warning Limit		+		+
Bit Mask, Bit String(s)	Status Flags		-		+
Bit Mask, Bit String(s)	Event Parameters		-		+
Bit String(s)	List of Values		-		-
Time delay	Alarm delay		+		+
Notify type	Notify type		-		+
Notification class	Notification class		-		+
Event: To Off-Normal, To Fault, Back to Normal <i>“selectable under Reporting, see Reporting”</i>	Reporting: To Off-Normal, To Fault, Back to Normal		+		+
Reporting	Reporting		+		+
Acknowledged)	<i>“n.a.”</i>		+		-
Last transition	<i>“n.a.”</i>		-		-
<i>“n.a.”</i>	BACnet object ID		-		-
Event state	<i>“n.a.”</i>		-		-
Object type	<i>“n.a.”</i>		-		-
Read access level	Read access level		-		+
Write access level	Write access level		-		+

NOTE: Comments are written in *italic* and in “quotation marks”

Multi-State Input

Property Denotation			Online-Editing		Offline-Editing
Eagle Web Interface	CARE	BACnet	Eagle Web Interface	BACnet	CARE
"Datapoint name displayed in title line of dialog"	Datapoint Name		-		+
GENERAL					
Type (Type/Inst.)	"n.a."		-		-
#States	States		-		-
Description	Descriptor	description	-	+	+
Mapping	"n.a."		-		-
Type / NV type			-		+
Direction	Input or output (NV) and hardware source (onboard, panel, Lon)		-		+
Read access level	Read access level		-		+
Write access level	Write access level		-		+
ALARMING					
Notification class	Notification class	notification-class	+	+	+
Notify type	Notify type	notify-type	-	+	+
Event: To Off-Normal, To Fault, Back to Normal "selectable under Reporting, see Reporting"	Reporting: To Off-Normal, To Fault, Back to Normal		+		+
Reporting	Reporting	event-enable	+	+	+
Acknowledged)	"n.a."		-		-
Last transition	"n.a."		-		-
State Text	State Texts		-		+
State Text: Is Alarm Condition Is Fault Condition	States: In Alarm Fault	alarm-values fault values	+	+	+
Suppress alarm	"n.a."		-		-
Alarm delay	Alarm delay	time-delay	+	+	+
VALUES					
Auto, Manual Active / Inactive Text	"n.a."		+		-
Reliability	"n.a."		-		-
In alarm	"n.a."		-		-
Fault	"n.a."		-		-
Overridden	"n.a."		-		-
Out of Service	"n.a."		-		-
Alarm text, "displayed in alarm buffer"	Alarm text		-		+
"assigned to value"	Engineering unit		-		+
"n.a."	Characteristic		-		+
"n.a."	Point role (EDK)		-		+
"n.a."	BACnet Object Type		-		-
"n.a."	BACnet Object ID		-		-
"n.a."	BACnet Object Instance Number		-		-
EVENT ENROLLMENTS					
Event Enrollments	EVENT ENROLLMENTS		+		+
Name	Name		-		+
Description	Description		-		+

Property Denotation			Online-Editing		Offline-Editing
Eagle Web Interface	CARE	BACnet	Eagle Web Interface	BACnet	CARE
Event type	Event type		-		-
High Limit	High Warning Limit		+		+
Low Limit	Low Warning Limit		+		+
Bit Mask, Bit String(s)	Status Flags		-		+
Bit Mask, Bit String(s)	Event Parameters		-		+
Bit String(s)	List of Values		-		-
Time delay	Alarm delay		+		+
Notify type	Notify type		-		+
Notification class	Notification class		-		+
Event: To Off-Normal, To Fault, Back to Normal <i>“selectable under Reporting, see Reporting”</i>	Reporting: To Off-Normal, To Fault, Back to Normal		+		+
Reporting	Reporting		+		+
Acknowledged)	<i>“n.a.”</i>		+		-
Last transition	<i>“n.a.”</i>		-		-
<i>“n.a.”</i>	BACnet object ID		-		-
Event state	<i>“n.a.”</i>		-		-
Object type	<i>“n.a.”</i>		-		-
Read access level	Read access level		-		+
Write access level	Write access level		-		+

NOTE: Comments are written in *italic* and in “quotation marks”

Multi-State Output

Property Denotation			Online-Editing		Offline-Editing
Eagle Web Interface	CARE	BACnet	Eagle Web Interface	BACnet	CARE
"Datapoint name displayed in title line of dialog"	Datapoint Name		-		+
GENERAL					
Type (Type/Inst.)	"n.a."		-		-
#States	States		-		-
Description	Descriptor	description	-	+	+
Mapping	"n.a."		-		-
Name / NV Name "automatically generated by CARE"-- Type / NV type			-		+
Direction	Input or output (NV) and hardware source (onboard, panel, Lon)		-		+
Read access level	Read access level		-		+
Write access level	Write access level		-		+
ALARMING					
Notification class	Notification class	notification-class	+	+	+
Notify type	Notify type	notify-type	-	+	+
Event: To Off-Normal, To Fault, Back to Normal "selectable under Reporting, see Reporting"	Reporting: To Off-Normal, To Fault, Back to Normal		+		+
Reporting	Reporting	event-enable	+	+	+
Acknowledged)	"n.a."		-		-
Last transition	"n.a."		-		-
Suppress alarm	"n.a."		+		-
Alarm delay	Alarm delay		+		+
VALUES					
Auto, Manual Active / Inactive Text	"n.a."		+		-
Manual Life Safety	"n.a."		-		-
Feedback Point	Feedback point		-	-	+
Reliability	"n.a."		-		-
In alarm	"n.a."		-		-
Fault	"n.a."		-		-
Overridden	"n.a."		-		-
Out of Service	"n.a."		-		-
Alarm text, "displayed in alarm buffer"	Alarm text		-		+
"assigned to value"	Engineering unit		-		+
"n.a."	Characteristic		-		+
"n.a."	Point role (EDK)		-		+
"n.a."	BACnet Object Type		-		-
"n.a."	BACnet Object ID		-		-
"n.a."	BACnet Object Instance Number		-		-
COMMAND PRIORITIES					
Relinquish default	Relinquish default	relinquish-default	+	+	+

Property Denotation			Online-Editing		Offline-Editing
Eagle Web Interface	CARE	BACnet	Eagle Web Interface	BACnet	CARE
EVENT ENROLLMENTS			+		+
Name	Name		-		+
Description	Description		-		+
Event type	Event type		-		-
High Limit	High Warning Limit		+		+
Low Limit	Low Warning Limit		+		+
Bit Mask, Bit String(s)	Status Flags		-		+
Bit Mask, Bit String(s)	Event Parameters		-		+
Bit String(s)	List of Values		-		-
Time delay	Alarm delay		+		+
Notify type	Notify type		-		+
Notification class	Notification class		-		+
Event: To Off-Normal, To Fault, Back to Normal <i>“selectable under Reporting, see Reporting”</i>	Reporting: To Off-Normal, To Fault, Back to Normal		+		+
Reporting	Reporting		+		+
Acknowledged)	<i>“n.a.”</i>		+		-
Last transition	<i>“n.a.”</i>		-		-
<i>“n.a.”</i>	BACnet object ID		-		-
Event state	<i>“n.a.”</i>		-		-
Object type	<i>“n.a.”</i>		-		-
Read access level	Read access level		-		+
Write access level	Write access level		-		+

NOTE: Comments are written in *Italic* and in “quotation marks”

Multi-State Value

Property Denotation			Online-Editing		Offline-Editing
Eagle Web Interface	CARE	BACnet	Eagle Web Interface	BACnet	CARE
"Datapoint name displayed in title line of dialog"	Datapoint Name		-		+
GENERAL					
Type (Type/Inst.)	"n.a."		-		-
#States	States		-		-
Description	Descriptor	description	-	+	+
Read access level	Read access level		-		+
Write access level	Write access level		-		+
ALARMING					
Notification class	Notification class	notification-class	+	+	+
Notify type	Notify type	notify-type	-	+	+
Event: To Off-Normal, To Fault, Back to Normal " <i>selectable under Reporting, see Reporting</i> "	Reporting: To Off-Normal, To Fault, Back to Normal		+		+
Reporting	Reporting	event-enable	+	+	+
Acknowledged)	"n.a."		-		-
Last transition	"n.a."		-		-
State Text	State Texts		-		+
State Text: Is Alarm Condition Is Fault Condition	States: In Alarm Fault	alarm-values fault values	+	+	+
Suppress alarm	"n.a."		-		-
Alarm delay	Alarm delay	time-delay	+	+	+
VALUES					
Auto, Manual Active / Inactive Text	"n.a."		+		-
Use as setpoint	Setpoint		-	-	+
Manual Life Safety	"n.a."		-		-
Reliability	"n.a."		-		-
EOH/EOV Optimization	EOH/EOV Optimization		+		+
In alarm	"n.a."		-		-
Fault	"n.a."		-		-
Overridden	"n.a."		-		-
Out of Service	"n.a."		-		-
COMMAND PRIORITIES					
Relinquish default	Relinquish default	Relinquish-default	+	+	+
Alarm text, "displayed in alarm buffer"					
"assigned to value"	Alarm text		-		+
"n.a."	Engineering unit		-		+
"n.a."	Characteristic		-		+
"n.a."	Point role (EDK)		-		+
"n.a."	BACnet Object Type		-		-
"n.a."	BACnet Object ID		-		-
"n.a."	BACnet Object Instance		-		-
EVENT ENROLLMENTS					
Name	Name		+		+
			-		+

Property Denotation			Online-Editing		Offline-Editing
Eagle Web Interface	CARE	BACnet	Eagle Web Interface	BACnet	CARE
Description	Description		-		+
Event type	Event type		-		-
High Limit	High Warning Limit		+		+
Low Limit	Low Warning Limit		+		+
Bit Mask, Bit String(s)	Status Flags		-		+
Bit Mask, Bit String(s)	Event Parameters		-		+
Bit String(s)	List of Values		-		-
Time delay	Alarm delay		+		+
Notify type	Notify type		-		+
Notification class	Notification class		-		+
Event: To Off-Normal, To Fault, Back to Normal <i>“selectable under Reporting, see Reporting”</i>	Reporting: To Off-Normal, To Fault, Back to Normal		+		+
Reporting	Reporting		+		+
Acknowledged)	<i>“n.a.”</i>		+		-
Last transition	<i>“n.a.”</i>		-		-
<i>“n.a.”</i>	BACnet object ID		-		-
Event state	<i>“n.a.”</i>		-		-
Object type	<i>“n.a.”</i>		-		-
Read access level	Read access level		-		+
Write access level	Write access level		-		+

NOTE: Comments are written in *italic* and in “quotation marks”

Pulse Converter

Property Denotation			Online-Editing		Offline-Editing
Eagle Web Interface	CARE	BACnet	Eagle Web Interface	BACnet	CARE
<i>"Datapoint name displayed in title line of dialog"</i>	Datapoint Name		-		+
GENERAL					
Type (Type/Inst.)	"n.a."		-		-
Description	Descriptor	description	-	+	+
Mapping	"n.a."		-		-
Name / NV Name <i>"automatically generated by CARE"</i> --Type / NV type			-		+
Direction	Input or output (NV) and hardware source (onboard, panel, Lon)		-		+
Read access level	Read access level		-		+
Write access level	Write access level		-		+
ALARMING					
Notification class	Notification class	notification-class	+	+	+
Notify type	Notify type	notify-type	-	+	+
Event: To Off-Normal, To Fault, Back to Normal <i>"selectable under Reporting, see Reporting"</i>	Reporting: To Off-Normal, To Fault, Back to Normal	event-state	+	+	+
Reporting	Reporting	event-enable	+	+	+
Acknowledged)	"n.a."		-		-
Last transition	"n.a."		-		-
High limit enable	High limit Reporting	high-limit	+	+	+
Low limit enable	Low limit Reporting	low-limit	+	+	+
Deadband	Deadband	deadband	+	+	+
Suppress alarm	"n.a."		-		-
Alarm delay	Alarm delay	time-delay	+	+	+
VALUES					
Present Value (<i>"Reset to"</i>)	"n.a."		+		-
Reset to	"n.a."				
Time of last reset	"n.a."		-		-
Reliability	"n.a."		-		-
In alarm	"n.a."		-		-
Fault	"n.a."		-		-
Overridden	"n.a."		-		-
Out of Service	"n.a."		-		-
Increment	Change of value increment	cov-increment	+	+	+
Period	COV Period	cov-period	+	+	+
Alarm text, <i>"displayed in alarm buffer"</i>	Alarm text	relinquish-default	-	+	+
<i>"assigned to value"</i>	Engineering unit		-		+
"n.a."	Scaling factor		-		+
"n.a."	Point role (EDK)		-		+
"n.a."	BACnet Object Type		-		-

Property Denotation			Online-Editing		Offline-Editing
Eagle Web Interface	CARE	BACnet	Eagle Web Interface	BACnet	CARE
"n.a."	BACnet Object ID		-		-
"n.a."	BACnet Object Instance Number		-		-
EVENT ENROLLMENTS					
Name	Name		-		X
Description	Description		-		X
Event type	Event type		-		-
High Limit	High Warning Limit		X		X
Low Limit	Low Warning Limit		X		X
Deadband	Deadband		X		X
Bit Mask, Bit String(s)	Status Flags		-		X
Bit Mask, Bit String(s)	Event Parameters		-		X
Bit String(s)	List of Values		-		-
Time delay	Alarm delay		X		X
Notify type	Notify type		-		X
Notification class	Notification class		-		X
Event: To Off-Normal, To Fault, Back to Normal <i>"selectable under Reporting, see Reporting"</i>	Reporting: To Off-Normal, To Fault, Back to Normal		X		X
Reporting	Reporting		X		X
Acknowledged)	"n.a."		X		-
Last transition	"n.a."		-		-
"n.a."	BACnet object ID		-		-
Event state	"n.a."		-		-
Object type	"n.a."		-		-
Read access level	Read access level		-		X
Write access level	Write access level		-		X

NOTE: Comments are written in *italic* and in "quotation marks"

Reference Input

Property Denotation			Online-Editing		Offline-Editing
Eagle Web Interface	CARE	BACnet	Eagle Web Interface	BACnet	CARE
<i>"Datapoint name displayed in title line of dialog"</i>	Datapoint Name		-		+
Auto	"n.a"		-		-
Reliability	"n.a"		-		-
Object ID	BACnet Object ID		-		-
Object Type	BACnet Object Type		-		-
Property	Property		-		+
Destination Point Location	Reference		-		+
Out of service	"n.a"		+		-
"n.a."	BACnet Instance Number		-		-
"n.a."	Initial value		-		+
"n.a."	Read access level		-		X
"n.a."	Write access level		-		X

NOTE: Comments are written in *Italic* and in "quotation marks"

Reference Output

Property Denotation			Online-Editing		Offline-Editing
Eagle Web Interface	CARE	BACnet	Eagle Web Interface	BACnet	CARE
<i>"Datapoint name displayed in title line of dialog"</i>	Datapoint Name		-		+
Auto	"n.a"		-		-
Reliability	"n.a"		-		-
Value	Priority for writing		-		+
Object ID	BACnet Object ID		-		-
Object Type	BACnet Object Type		-		-
Property	Property		-		+
Destination Point Location	Reference		-		+
Out of service	"n.a"		+		-
"n.a."	BACnet Instance Number		-		-
"n.a."	Initial value		-		+
"n.a."	Read access level		-		X
"n.a."	Write access level		-		X

NOTE: Comments are written in *Italic* and in "quotation marks"

I/O Initialization

Input Datapoints (AI, BI)

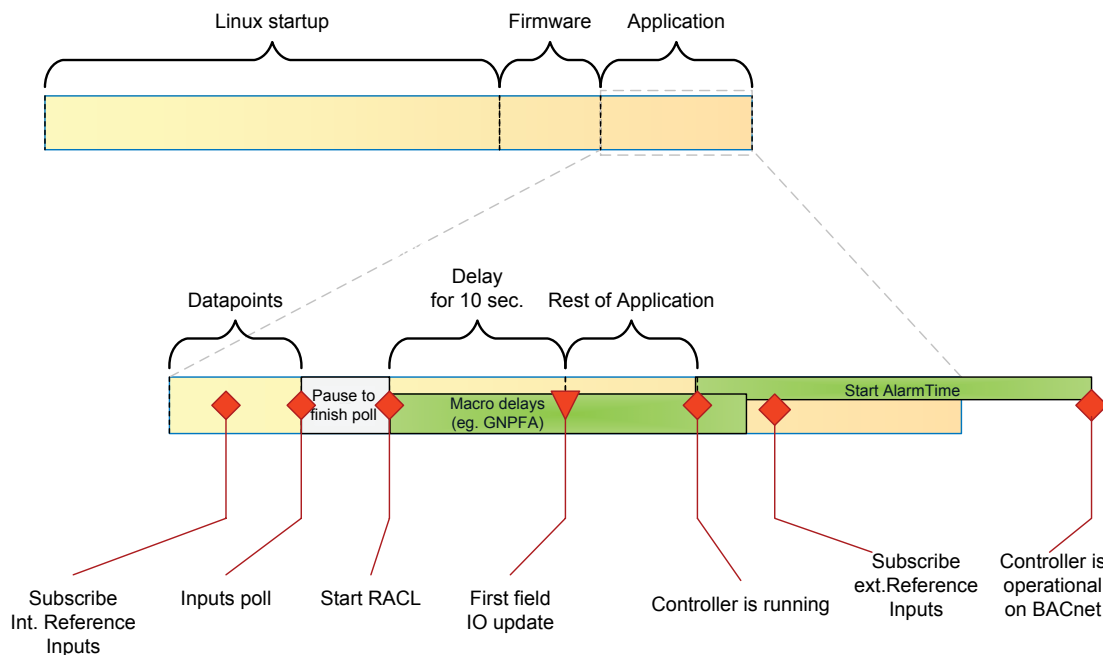

Start BACnet input datapoints will be initialized with the value 'zero'. After initialization, the field devices values will be polled from the input module. During the poll all startup activities are stopped. (Example: If a module is not present, it takes longer for startup).

Reference inputs inside the controller are updated during the "Datapoints" stage. Reference inputs (3rd party and in the same CARE project) from external sources are initialized after "Controller is running".

The Firmware ensures that the outputs are not written before RACL has finished the first loop. The first heartbeat update for the output datapoint is 10 seconds after "LON inputs poll". Outputs which are changing are updated directly. Note: Typically there is an additional delay configured in the control loops (e.g. with the macro GNPFA). It starts with the first start of RACL.

Alarm behavior At the beginning, all input points are not in alarm by default except those of which input values have caused an alarm.

After the start alarm time has expired, an alarm will be saved in the alarm buffer, shown in the alarm list and reported to the BACnet client as long as the alarm exists. It starts after the Controller is running.

Restart, Reset, Power Failure, Application- and Firmware Download

The following values/statuses will be cyclically saved in the Flash memory and restored after restart, reset or power failure of the Eagle controller.

- Runtime counter
- Last reset time
- Elapsed active time
- Out of Service flag
- Points in manual operating mode

The advantage here is that these values will survive an application and firmware download.

When an EAGLE controller is replaced, these values cannot be transferred to the new EAGLE controller.

Output Datapoints (AO, BO)

Start BACnet output datapoints will be initialized with the relinquish default value. After the first heartbeat, the relinquish default value or the present value created out of the application will be sent to the LON bus.

The output priority 1 "Manual Life Safety" represents the status of a local manual override switch at the LON module (XFL and XFC modules). This information is read from the Lon Module override switch after every start of the controller.

In principle, the value with the highest BACnet array priority (2 – 8) will be saved in the battery-retentive RAM (see "Manual Override" section below).

Alarm behavior At the beginning, all output points are not in alarm by default except those of which output values have caused an alarm.

After the start alarm time has expired, an alarm will be saved in the alarm buffer, shown in the alarm list and reported to the BACnet client as long as the alarm exists.

Restart, Reset, Power Failure, Application- and Firmware Download

The following values/statuses will always be saved in the battery-retentive RAM and restored after restart, reset, or power failure of the Eagle controller.

- Runtime counter
- Last reset time
- Elapsed active time
- Highest output priority of the priorities 2 to 8

NOTE: The datapoint value and the status of the 'Out of Service' flag will not be transmitted to the LON bus and will not be saved in battery retentive RAM.

Manual Override The value with the highest BACnet array priority (2 – 8) will be saved in the battery-retentive RAM and will then be restored after restart, reset, or power failure of the Eagle controller.

Reference Inputs

Start Starts with the 'Start Value' defined in CARE. Later the referencing input value will be taken. For more information on the COV value, please refer also to the "Change of Value Increment" and the "View / Edit Values" sections).

NOTE: Reference inputs are not visible in the Eagle Web Interface.

Reference inputs will try to subscribe COV. If the source device supports COV, COV will be subscribed with a life-time of 1800 seconds, and will be re-subscribed every 900 seconds. If the source device does not subscribe COV, the source object (datapoint) will be polled.

In case the connected data point does not support COV, the poll rate set in CARE defines the interval in sec, that the reference input polls the connected data point. If the connected data point does support COV, then the poll rate has no effect. So the poll rate does not ensure a fault signal within the poll rate time when a connection is lost. In case of a loss of communication the fault flag will latest be set after 30 minutes

Summary

The following table gives an overview of the I/O initialization of the various datapoints regarding alarming, manual override and behavior at start, restart and power failure.

	I/O Initialization				
	Inputs	Outputs	Values	Pulse Converter	Reference Inputs
Initialization (Initial value)	'0'. Continued with value transmitted from field device	'Relinquish default'. With first heartbeat, 'Relinquish default' or application value is sent to LON bus. Manual Override switch is read from LON module	'Relinquish default'.		'Start value' defined in CARE. Continued with referencing input value.
Alarming	After start alarm time has expired, alarm is saved in the alarm buffer, shown in the alarm list and reported to the BACnet client as long as the alarm exists.	After start alarm time has expired, alarm is saved in the alarm buffer, shown in the alarm list and reported to the BACnet client as long as the alarm exists.	After start alarm time has expired, alarm is saved in the alarm buffer, shown in the alarm list and reported to the BACnet client as long as the alarm exists.		
Battery-retentive Flash Storage / Restore after Restart, Reset, Power Failure	Runtime Counter Last reset time Elapsed active time Out of Service Manual value	Runtime Counter Last reset time Elapsed active time Value with highest BACnet array priority (2 – 8), includes Manual value	Last reset time Elapsed active time Value with highest BACnet array priority (2 – 8), includes Manual value	Count value Reset time	
Manual Override	Saved in the battery-retentive RAM	Saved in the battery-retentive RAM	Saved in the battery-retentive RAM		

Setting Datapoints into Manual Mode (Manual Override)

A datapoint's current value can be overridden manually either by:

- Entering the manual value in the datapoint's dialog box in the Eagle Web Interface or BACnet client (applies to all datapoints). This is often called "fixing a point"

Or,

- Using manual override controls on the analog output (XFL522) or digital output (XFL524) modules (applies to analog and binary output datapoints only). See also "Feedback Value" section.

NOTE: If AO and BO datapoints are created with switches, the manual override control of the modules are reflected in the command priorities (level 1 = manual life safety).

NOTE: Switching a point between Auto and Manu operating mode only causes an alarm if the value or state is in the Off-Normal range or status, and if the alarming is enabled.

Setpoint Input for Value Datapoints

If in CARE the "setpoint" property is set for a value datapoint, the **Use as Setpoint** field will be displayed in the HTML Interface for overwriting the present value without the necessity of setting the datapoint into manual mode before. Instead, the present value can be overwritten quickly by entering the value in the **Use as Setpoint** field displayed in the HTML interface.

NOTE: The field will not be available in the HTML Interface if the property is not enabled in CARE.

Setting and Detecting Manual Overrides of Datapoints

- Procedure** 1. In the *Details* dialog box of the selected datapoint, select the *Values* tab.

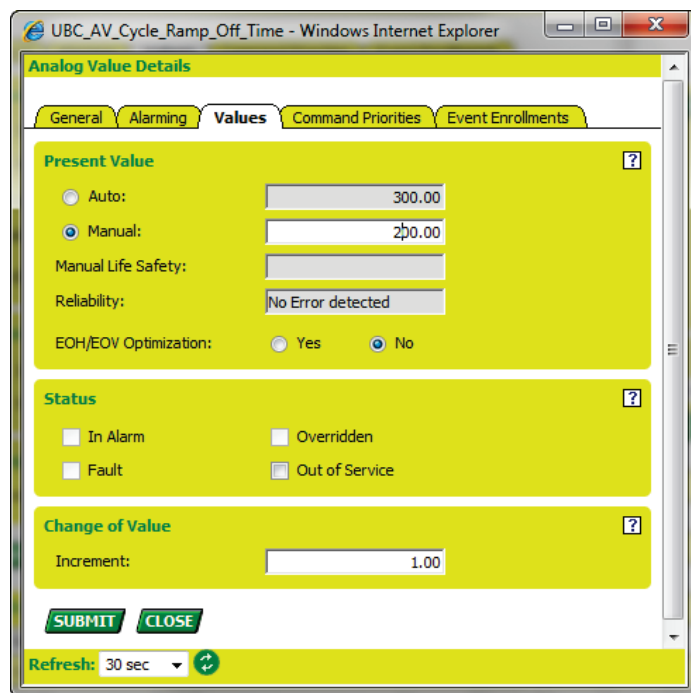

2. Click the **Manual** radio button and enter the value into the field.

Or, to override an analog or binary input datapoint physically, adjust the override control on the module.

3. To detect and view if an input datapoint is in manual override, you can select the *Datapoints* screen.

Datapoint List								
Sort by: Name		Entries per Page: 50						
Name	Description	Value/Unit	Event State	Type	ALM	FLT	OVR	OOS
UBC_AV_Alarm_1		0.00 K	Low Limit	AV	<input checked="" type="checkbox"/>	<input type="checkbox"/>	<input type="checkbox"/>	<input type="checkbox"/>
UBC_AV_Alarm_2		0.00 K	Low Limit	AV	<input checked="" type="checkbox"/>	<input type="checkbox"/>	<input type="checkbox"/>	<input type="checkbox"/>
UBC_AV_Cycle_Ramp_Off_Time		200.00	Normal	AV	<input type="checkbox"/>	<input type="checkbox"/>	<input checked="" type="checkbox"/>	<input type="checkbox"/>

RESULT: Datapoints in manual override (in this case BACnet priority 8 = "manual operator" is active) will display the "overridden" (OVR) flag checked. Physical and binary input datapoints will in addition display the "out of service" (OOS) flag checked. The BACnet Standard specifies an input to be "out of service", when it is decoupled from the field signal.

Status Flag Indications

Input Point Status Flags

When an input datapoint is set into Manual mode and its value will be overwritten, the `overridden` and `out of service` flags are set. The enabled `out of service` flag indicates that the datapoint is decoupled from the physical input (field device) to prevent a field device value from instantly overwriting the manual value in the next scan cycle. The `fault` flag is enabled if the reliability is one of the following:

- No Sensor
- Open Loop
- Shorted Loop
- Process Error
- Unreliable Other

No Error Detected	Loop is in proper condition, that is, present value is reliable; that is, no other fault has been detected.
No Sensor	No field device value update has been received. <u>For LON points only:</u> The heartbeat timer has expired and the following poll has failed. Note that the heartbeat must have been activated in CARE. Sensor may not be connected.
Open Loop	No sensor connected
Shorted Loop	Input is short-circuited
Process Error	Internal error, not possible to read input value
Unreliable Other	Invalid Value is received. <u>For LON points only</u> With INVALID Match: the point will work with the value defined by INVALID Match <u>For all point types</u> No INVALID Match: The point will work with last received value. The controller has detected that the present value is unreliable, but none of the other conditions describe the nature of the problem. A generic fault other than those listed above has been detected, e.g., a Binary Input is not cycling as expected.

Output Point Status Flags

When an output datapoint is set into Manual mode, its current value will be overwritten by the manual value, which then has the higher priority = `Manual Operator` (8) and the overridden flag is set. As long as no other process of higher priority than (8) writes to the analog output, the manual value remains present.

The `fault` flag is enabled if the reliability is `No Output` which tells that the Acknowledged Service has failed.

No Error Detected	No fault has been detected.
No Output	Acknowledged Service has failed, or Hardware may be not connected

The `out of service` flag is enabled, if field device value updates to the output are blocked, for example by the BACnet client.

Alarm and Event Priority Classification

Alarms and events traversing the BACnet network need prioritization to assure that important information reaches its destination and is acted upon quickly. To assure alarm prioritization at the network level, the network priority as defined in the network layer protocol control is set automatically according to the alarm and event priority settings (see following table).

Alarm and Event Priority	Network Priority Association
00 – 63	Life Safety message
64 - 127	Critical Equipment message
128 - 191	Urgent message
192 - 255	Normal message

ALARM HANDLING

Alarm Behavior of Datapoints

Event States For any datapoint type, an application and/or product specific value range is defined in which the point is in the operating (event) state 'Normal'. If the point value has changed due to exceptional situations, the event state of a datapoint can be either 'Off-Normal' or 'Fault'.

The event states can be briefly described as follows:

Normal

Point is in normal operating state.

Off-Normal

Point value is out of normal range.

Fault

Point is prevented from proper operation. Point value can be in normal or out of normal range. Due to the maloperation of the point, the value is unreliable.

Causes for a fault can be, for example sensor and cable breaks. See "Status Flag indications for details.

High Limit

Point value has exceeded the high limit. Special case of the Off-Normal state of analog inputs and outputs (see also Alarm range properties in the table below).

Low Limit

Point value has dropped below the low limit. Special case of the Off-Normal state of analog inputs and outputs (see also Alarm range properties in the table below).

The alarm range of a datapoint is defined by the datapoint's specific alarm range properties.

Examples:

Datapoint Type	Alarm range properties
Analog input, analog output, analog value, pulse converter	High limit, low limit
Binary input, binary output, binary value, multi-state input, multistate value	Alarm value

For information on the detailed alarm behavior of a particular point type, please refer to the diagrams and descriptions in the following subsections.

Transition Events Whenever the event state of a datapoint changes, an alarm is generated by one of the following transition events:

Back To-Normal

The alarm is going to normal operating state.

To Off-Normal

The alarm reaches off-normal state.

To Fault

The alarm originates in a (physical) fault such as sensor break, etc.

Any alarm caused by a transition event is indicated by the enabled 'Alarm' status flag (see "Datapoint Status Flags" section).

Alarm Display / Alarm Notification

A transition event is the triggering step that generates a notification which can be received by the BACnet client, the Eagle Web Interface or a 3rd party BACnet client for displaying alarms. To display a transition event of a datapoint on a BACnet client, the following steps must have been done:

- Enable reporting of the event transitions by selecting the desired transition event options in CARE (offline) or the BACnet client (online).
Transition Events are: Back To-Normal, To Off-Normal, To Fault
- Select Notify Type “Alarm” in CARE (offline).
- Enable “High Limit” and “Low Limit” in CARE (offline) or in the Eagle Web Interface or via the BACnet client (online)
- Assigning a notification class to the datapoint (not necessary for the Eagle Web Interface, mandatory for BACnet client and 3rd party BACnet clients only).

Notification Class JOURNAL Usage

IMPORTANT

Any application that has been engineered by using the notification class JOURNAL will not lose it. After application upload into CARE, all notification classes which have been previously defined will be available in CARE for further engineering and download.

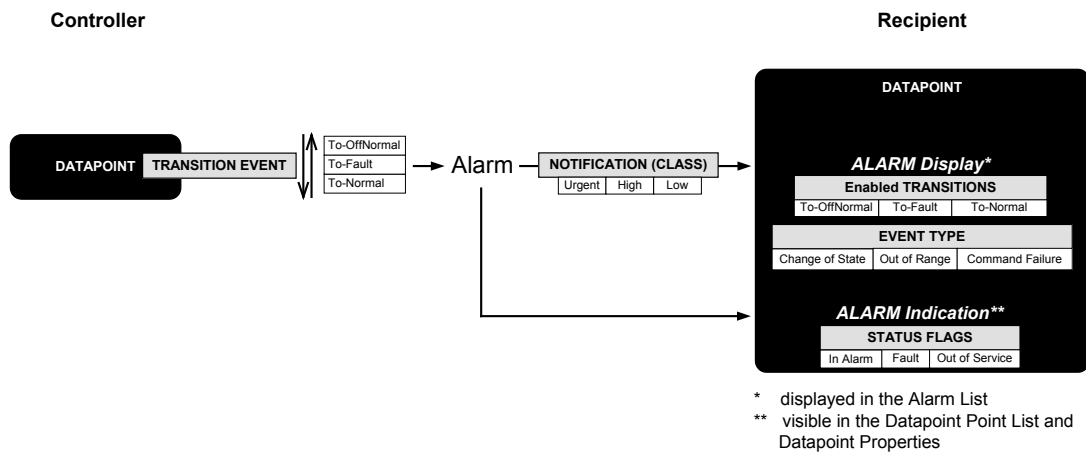

Fig. 8. Alarm Handling

The following table shows the relationship between categories and transitions as they are defined for the BACnet client in the CARE engineering tool by default.

Event (Alarm) Category	Transitions		
	To Normal	To Off-Normal	To Fault
Urgent (range 0...84)	83	0	42
High (range 85...169)	168	86	127
Low (range 170...250)	250	171	210

Datapoint Status Flags

The event state of a datapoint is indicated by the enabled/disabled status flags:

In Alarm

When enabled, the datapoint is in alarm. Cause can be faults and Off-Normal conditions.

Fault

When enabled, the datapoint or the physical input is not reliable, e.g. in case of sensor break (Open Loop). See “Status Flag Indications” for details.

Overridden

When enabled, the datapoint is in manual operating state. The value has been overwritten.

Out of Service

When enabled, this flag indicates that the physical datapoint is decoupled from the datapoint, e.g. in case of manual override for inputs. The present value displayed is not the present value, which would be delivered by the physical input.

NOTE: Multiple flag indications may be possible.

Example: A 'To-Fault transition' will also always enable the 'In Alarm' flag. Hence both, the 'In Alarm' and the 'Fault' status flags are enabled.

Alarm Buffer and Alarm Display

For the various datapoints, different triggering criteria must be fulfilled before an event is generated and reported (intrinsic reporting criteria). If all criteria are fulfilled, the event/alarm is generated and displayed in the alarm list. Depending on the datapoint type, the following three event types are described:

Datapoint type	Event triggering criteria (intrinsic reporting criteria)	Event type
Binary Input Binary Value Multi-state Input Multi-state Value	If present value changes to a new state for longer than the time delay AND the new transition is enabled in the event transitions options for reporting	CHANGE OF STATE
Analog Input Analog Output Analog Value Pulse Converter	If present value exceeds range between high limit and low limit for longer the time delay AND the new transition is enabled in the event transitions options for reporting and if high or low limit enable options are enabled OR Present value returns within the high limit - deadband to low Limit + deadband range for longer the time delay AND the new transition is enabled in the event transitions options for reporting and if high or low limit enable options are enabled	OUT OF RANGE
Binary Output Multi-state Output	If present value differs from feedback value for longer the time delay AND the new transition is enabled in the event transitions options for reporting NOTE: 'Feedback' value will be supported in a future version of Eagle	COMMAND FAILURE

Suppress Alarm Generation

If the alarm delay is set to 100,000 seconds or higher, the alarm will be suppressed. The 'In Alarm' flag and the 'State' will not change, even if the alarm conditions are reached. If the point is already in alarm state (Off-Normal) and the 'In Alarm' flag is set and the alarm delay is changed to 100,000 seconds or higher, the state of the point is set to 'Normal'.

Only the alarm conditions can be disabled with the alarm delay of 100,000 seconds or higher.

The fault condition cannot be disabled with alarm delay.

Start Alarm Time

The start alarm time is the time during which the notification of alarms is suppressed. The start alarm time will become effective upon every start/restart of the Eagle controller, e.g. power-on, application start, etc. Entering a start alarm time is requested to prevent alarm shower at start/restart of the controller. If alarms are still active after the start alarm time has elapsed, these alarms will be notified as usual.

Alarm Delay

Besides the datapoint's specific alarm values, e.g. high and low limit of an analog input, the alarm delay is important for the alarm behavior of all datapoint types.

The alarm delay determines how long a 'To-Off-Normal' or 'To-Normal transition' must exist before an alarm is generated.

Alarm Settings and Alarm Display for Analog Inputs and Outputs

For analog inputs and outputs, the event states and transitions according to the BACnet standard can be as follows:

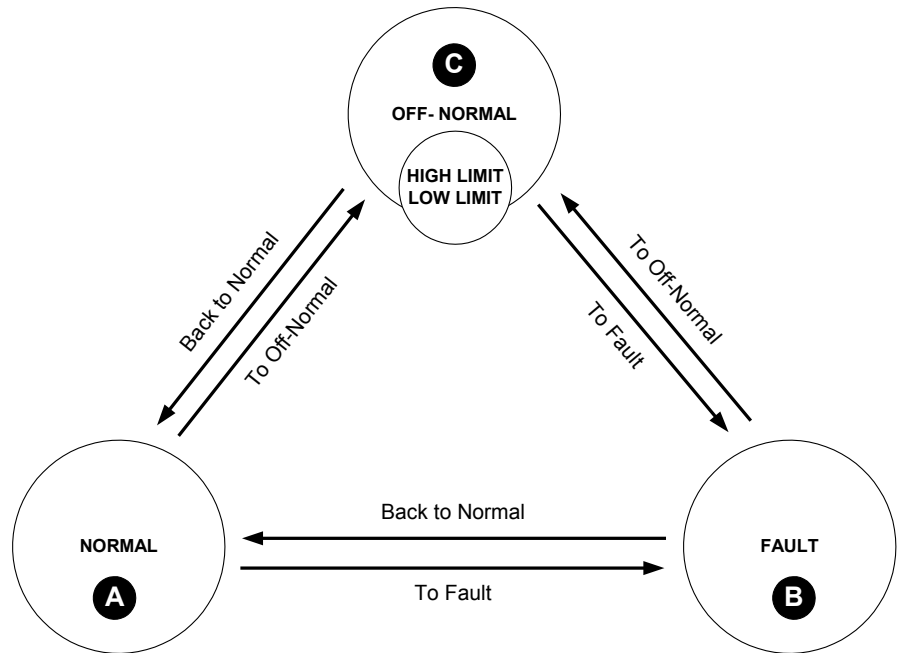

Besides the actual alarm value or alarm condition, the combination of the settings for intrinsic reporting (transitions) and Off-Normal conditions have a decisive influence on the alarm state displayed in the alarm buffer (BACnet client) and in the point dialog (see table):

Selected Event Transition (Reporting)		Selected Off Normal Condition		Allowed Event Transitions	Event State (Alarm Buffer)	Event State (Point Dialog)
Back To Normal	x			A ← B A ← C	Normal	Normal
To Off-Normal	x			A → C B → C	Off-Normal	Off-Normal
To Fault	x			A → B B ← C	Fault	Fault
		High Limit Enable	x	A → C A ← C	Off-Normal	Off-Normal
		Low Limit Enable	x	A → C A ← C	Off-Normal	Off-Normal

For analog input and output points, the event state display of an analog input or output point in the alarm buffer and in the point dialog are not the same if the following settings have been set:

The "To Off-Normal" reporting and the Off-Normal Conditions "High Limit Enable" and "Low Limit Enable" are disabled.

Due to these selections, the following transitions (dashed in the following graphic) are not possible:

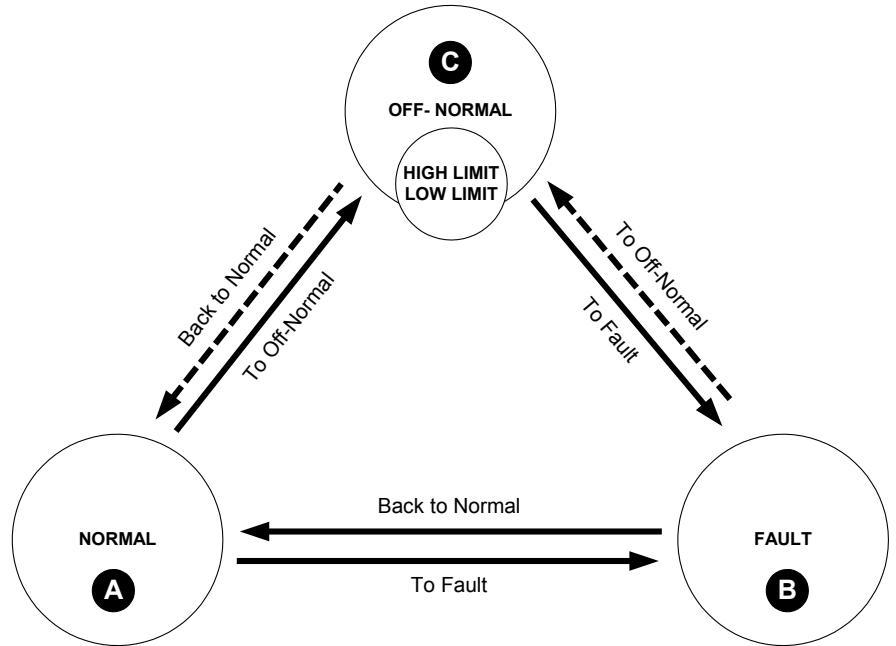
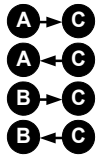

Recommendation Set the high and/or low limits to extremely high or low values, so that a real measured value will not be above the limits. Always enable the High limit Enable and Low Limit Enable options even if the Off-Normal Reporting is disabled.

Analog Input

The following diagram shows the alarm behavior of an analog input.

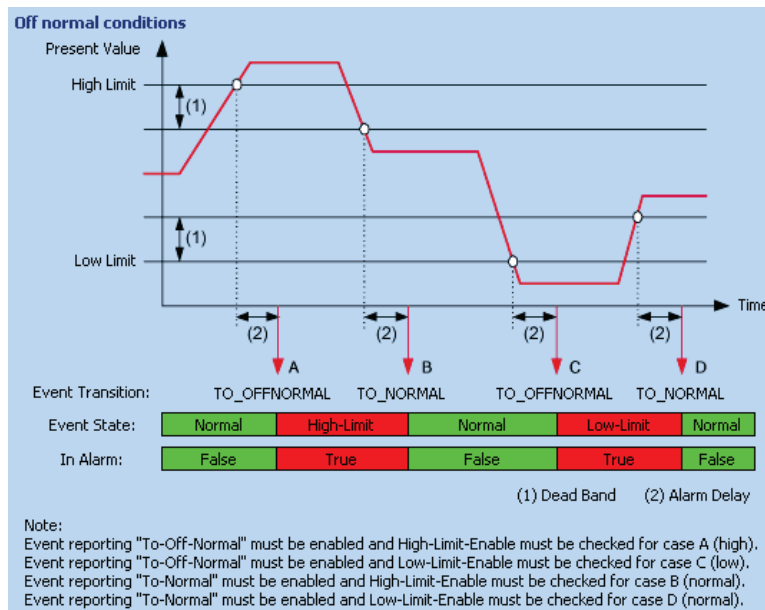

Fig. 9. Alarm behavior of analog input datapoint

Analog Output

The following diagram shows the alarm behavior of an analog output.

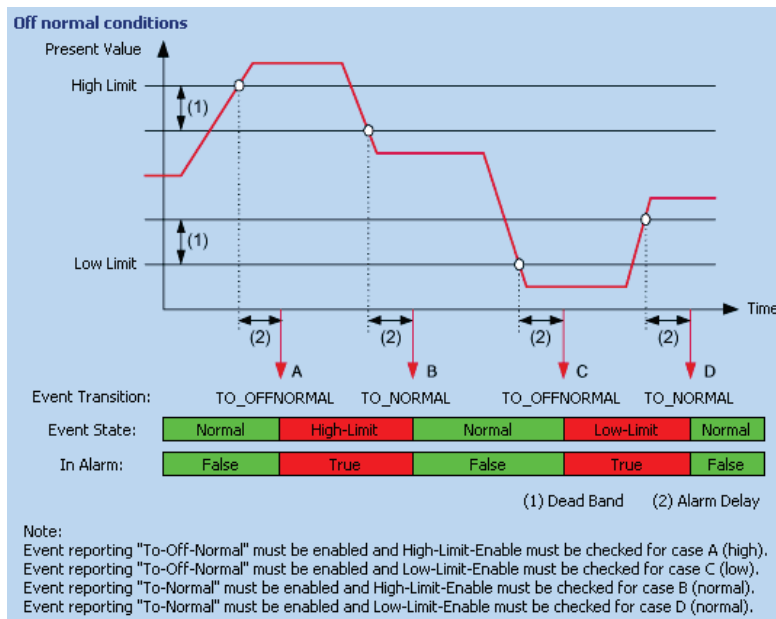

Fig. 10. Alarm behavior of analog output datapoint

Analog Value

The following diagram shows the alarm behavior of an analog value.

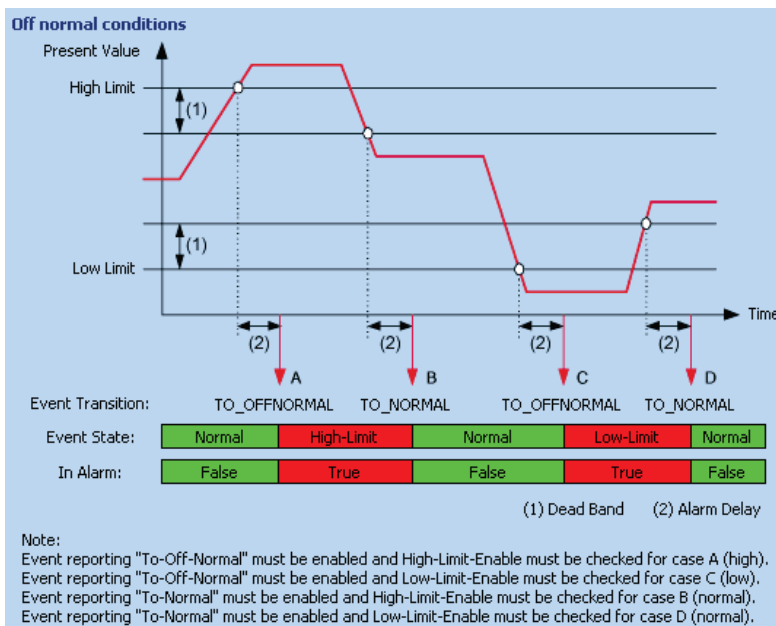

Fig. 11. Alarm behavior of analog value datapoint

Binary Input

The following diagram shows the alarm behavior of a binary input.

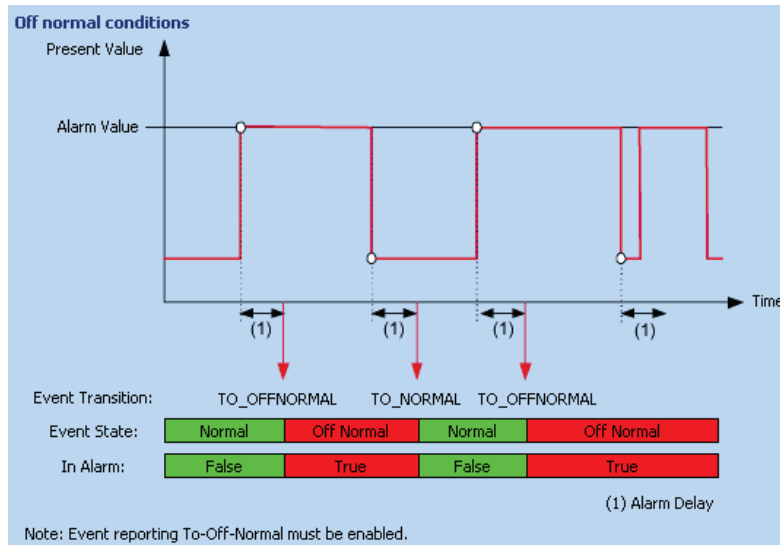

Fig. 12. Alarm behavior of binary input datapoint

Binary Output

The following diagram shows the alarm behavior of a binary output.

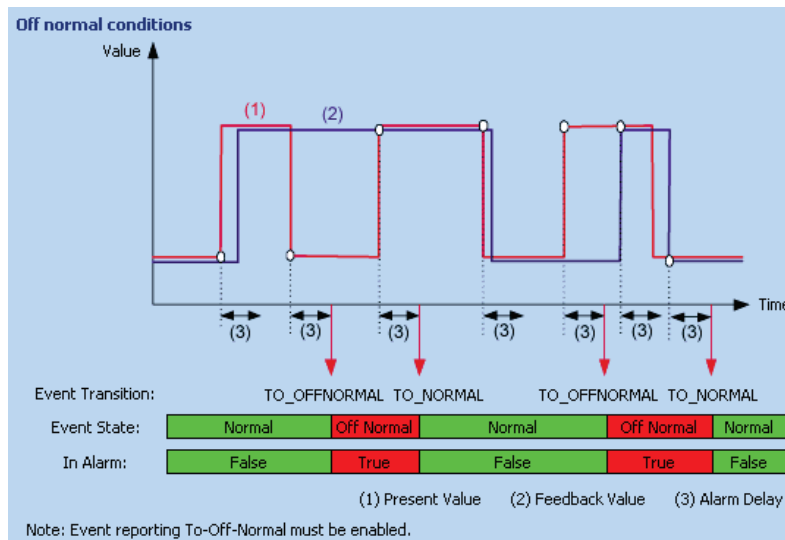

Fig. 13. Alarm behavior of binary output datapoint

Binary Value

The following diagram shows the alarm behavior of a binary value.

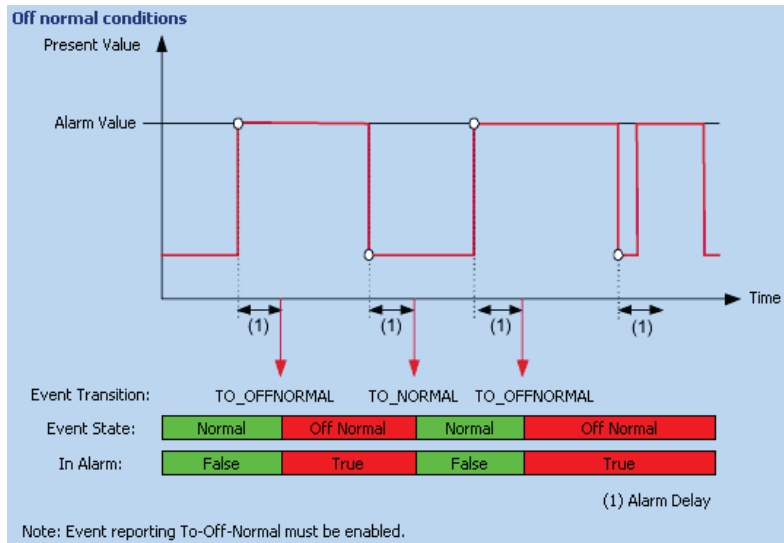

Fig. 14. Alarm behavior of binary value datapoint

Multi-state Input

The following diagram shows the alarm behavior of a multi-state input.

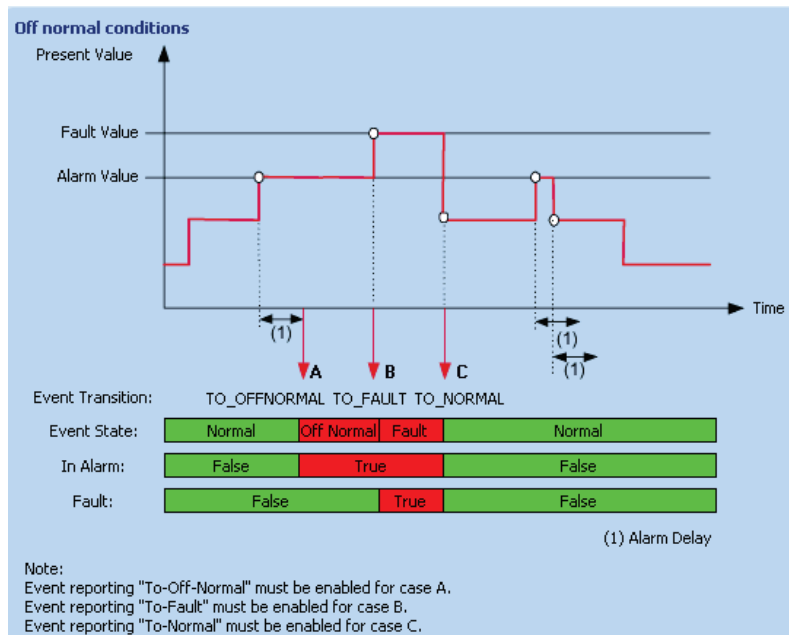

Fig. 15. Alarm behavior of multi-state input datapoint

Multi-state Output

The following diagram shows the alarm behavior of a multi-state output.

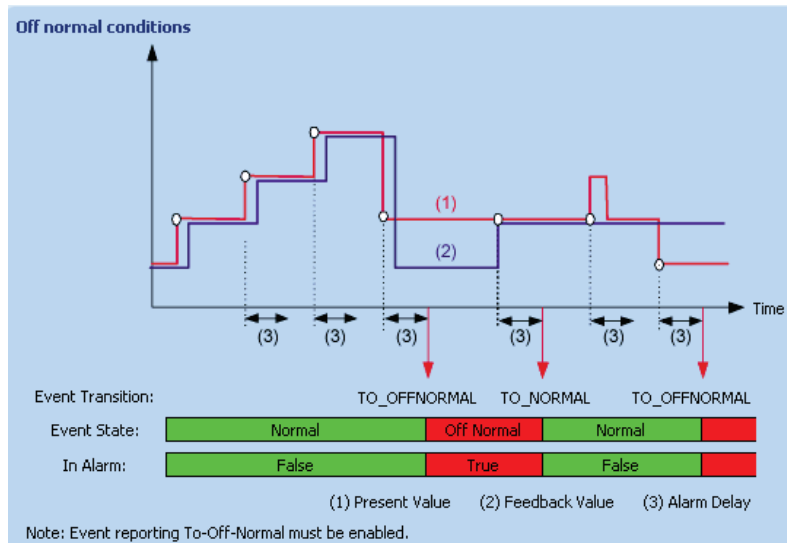

Fig. 16. Alarm behavior of multi-state output datapoint

Multi-state Value

The following diagram shows the alarm behavior of a multi-state input.

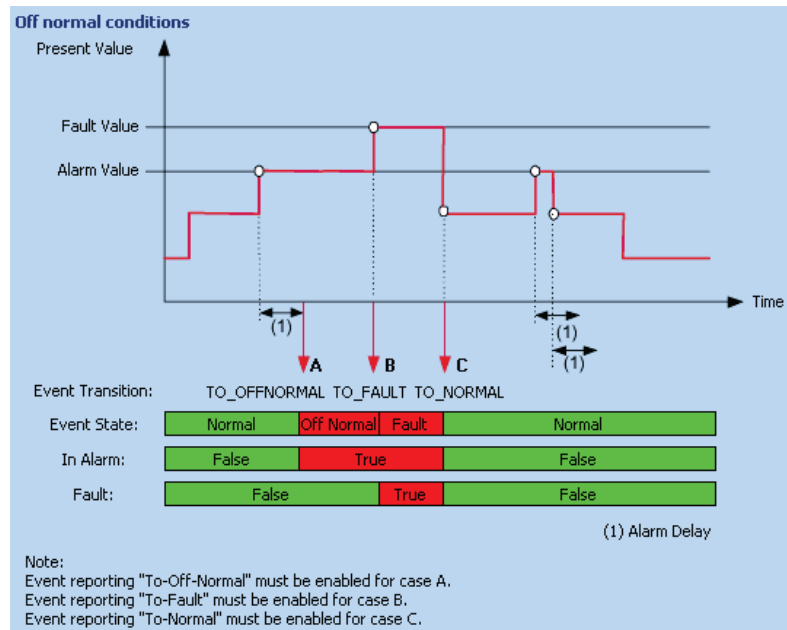

Fig. 17. Alarm behavior of multi-state value datapoint

Pulse Converter

The following diagram shows the alarm behavior of pulse converter.

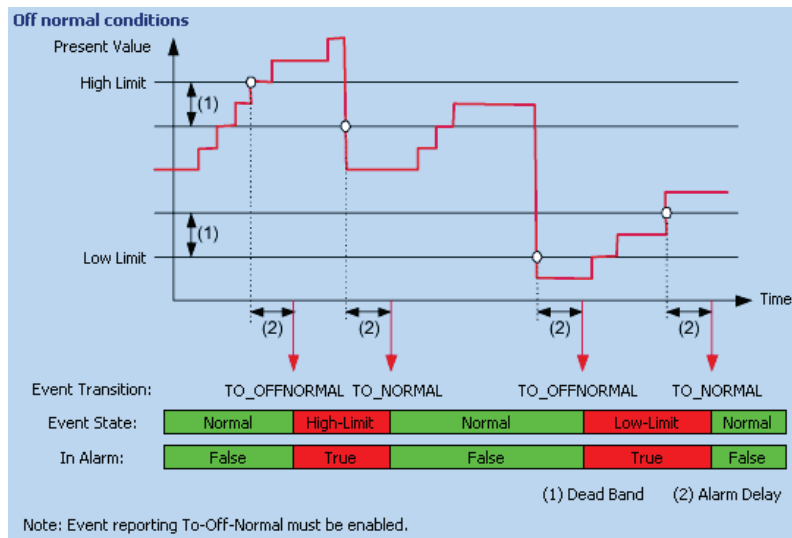

Fig. 18. Alarm behavior of pulse converter datapoint

Notification Class Manager

The notification class manager in CARE is used for adapting the alarming to the BACnet client and 3rd party BACnet clients according to the requirements.

This is done by creating, editing and deleting notification class objects. Notification class objects will be assigned to datapoints in order to enable alarming for datapoints.

About Notification Class Object Types

Notification class objects represent and contain information required for the distribution of event notifications within a BACnet system. Notification Classes are useful for event-initiating objects that have identical needs in terms of how their notifications should be handled, what the recipient(s) for their notifications should be, and how they should be acknowledged.

A notification class defines how event notifications shall be prioritized in their handling according to TO-OFFNORMAL, TO-FAULT, and TO-NORMAL events; whether these categories of events require acknowledgment (nearly always by a human operator); and what recipient devices (e.g. Eagle Web Interface, BACnet client) or processes should receive notifications.

The purpose of prioritization is to provide a means to ensure that alarms or event notifications with critical time considerations are not unnecessarily delayed. The possible range of priorities is 0 - 255. A lower number indicates a higher priority. Priorities may be assigned to TO OFF-NORMAL, TO FAULT, and TO NORMAL events individually within a notification class.

In CARE, the alarms/event notifications are prioritized by default as follows:

Event / Alarm Category	Transitions		
	To Normal	To Off-Normal	To Fault
Urgent (range 0...84)	83	0	42
High (range 85...169)	168	86	127
Low (range 170...250)	250	171	210

NOTE: The CARE ranges slightly differ from the event / alarm priority ranges defined in the BACnet standard which affects the associated network priority (see "Alarm and Event Priority Classification" section below).

The transitions have the following denotation:

Back To-Normal

The alarm is going to normal state, that is, the value of the datapoint remains under the high limit, or exceeds the low limit.

To Off-Normal

The alarm reaches off-normal state, that is, the datapoint value exceeds the high limit, or remains under the low limit.

To Fault

The alarm originates in a fault such as sensor break, etc. See "Point Flag Indications" for details.

The purpose of acknowledgment is to provide assurance that a notification has been acted upon by some other agent, rather than merely having been received correctly by another device. In most cases, acknowledgments come from human operators.

TO OFF-NORMAL, TO FAULT, and TO NORMAL events may, or may not, require individual acknowledgment within a notification class.

It is often necessary for event notifications to be sent to multiple recipients or to different recipients based on the time of day or day of week. Notification Classes may specify a list of recipients, each of which is qualified by time, day of week, and type of handling. A recipient is specified by a set of days of the week (Monday through Sunday) during which the recipient is considered viable by the Notification

Class object. In addition, each recipient has a FromTime and ToTime, which specify a window, on those days of the week, during which the recipient is viable. If an event that uses a notification class object occurs and the day is one of the days of the week that is valid for a given recipient and the time is within the window specified for the recipient, then the recipient shall be sent a notification. Recipients may be further qualified, as applicable, by any combination of the three event transitions TO OFF-NORMAL, TO FAULT, or TO NORMAL.

The recipient also defines the device to receive the notification and a process within the device. Processes are identified by numeric handles that are only meaningful to the recipient device. The administration of these handles is a local matter. The recipient device may be specified by either its unique Device Object Identifier or its BACnet Address. In the latter case, a specific node address, a multicast address, or a broadcast address may be used. The recipient further specifies whether the notification shall be sent using a confirmed or unconfirmed event notification.

How the notification class assignment is handled in CARE: please see the following graphic.

NOTIFICATION CLASSES AND EVENT HANDLING

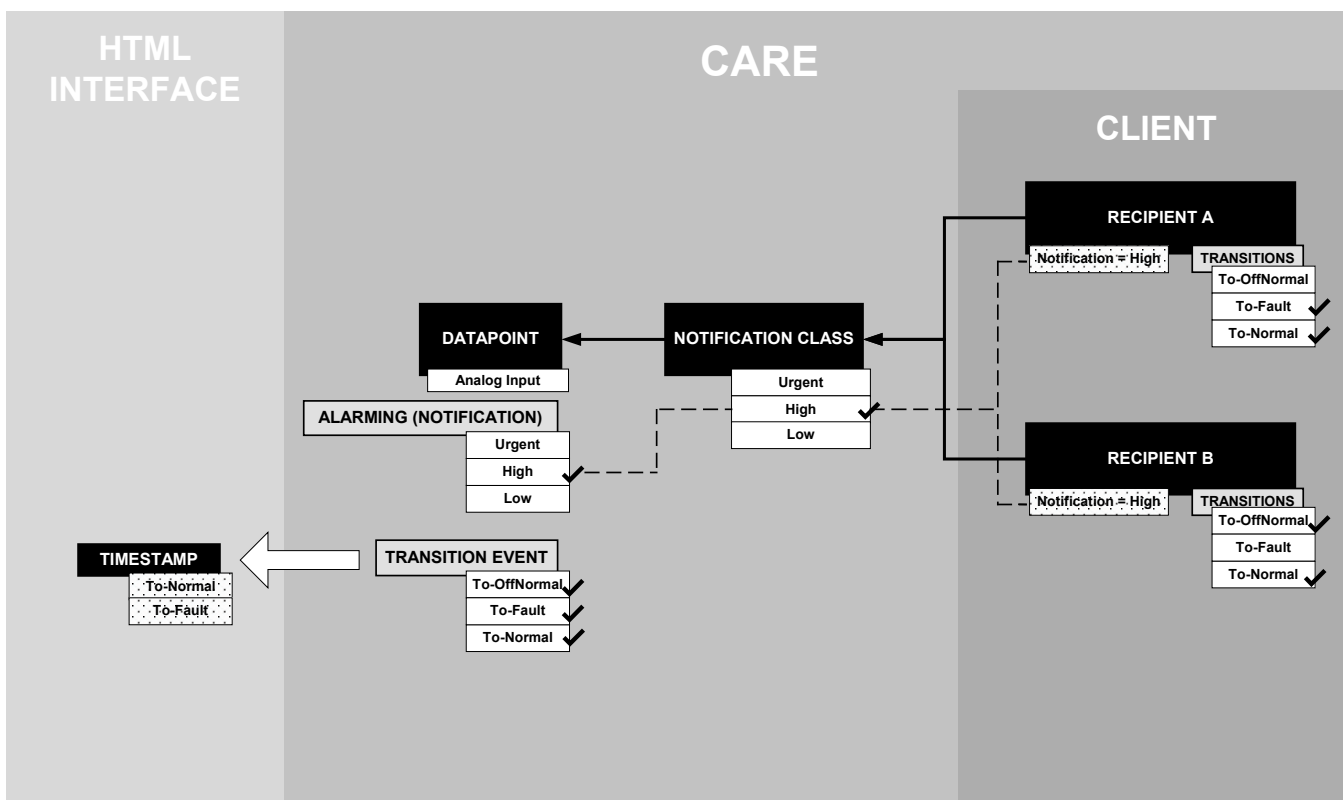

Fig. 19. Notification classes and event handling

Alarm and Event Priority Classification Alarms and events traversing the BACnet network need prioritization to assure that important information reaches its destination and is acted upon quickly. To assure alarm prioritization at the network level, the network priority as defined in the network layer protocol control is set automatically according to the alarm and event priority settings. The following table shows the alarm and event priorities classifications including semantic meaning.

Message Group	Priority Range	Network Priority	Description
Life Safety	00 – 31	Life Safety	Message Notifications related to an immediate threat to life, safety or health such as fire detection or armed robbery
Property Safety	32 – 63	Life Safety message	Notifications related as an immediate threat to property such as forced entry

Message Group	Priority Range	Network Priority	Description
Life Safety	00 – 31	Life Safety	Message Notifications related to an immediate threat to life, safety or health such as fire detection or armed robbery
Supervisory	64 – 95	Critical Equipment Message	Notifications related to improper operation, monitoring failure (particularly of Life Safety or Property Safety monitoring), or monetary loss
Trouble	96 - 127	Critical Equipment message	Notifications related to communication failure (particularly of Life Safety or Property Safety equipment)
Miscellaneous Higher Priority Alarm and Events	128 - 191	Urgent message	Higher-level notifications related to occupant discomfort, normal operation, normal monitoring, or return to normal
Miscellaneous Lower Priority Alarm and Events	192 - 255	Normal message	Lower-level notification related to occupant discomfort, normal operation, normal monitoring, or return to normal.

TIME PROGRAMS

Schedules and Calendars

Time programs comprise schedules and calendars.

Schedules Schedules are daily and weekly time programs.

Whenever you want, you can use schedules to enter the setpoint or status for any datapoint.

Schedules are assigned to plants. Each plant of a controller can have multiple schedules assigned and each schedule can command datapoints of that plant.

Each schedule specifies a list of datapoint properties to command (switchpoints) on a weekly basis. The week program defines the normal daily activity of the system by specifying which switchpoints are to be commanded each day of the week. The week program applies to a definable time period. There is only one week program per schedule.

Schedules offer 16 write priorities that define the priority for writing to the present value of output and value datapoints. Note, that only the priorities 9 to 16 are allowed in the controller.

Besides the week program, specific programs called exceptions can be created. Exceptions have higher priority than the week program and will overwrite the week program for a definable time period. Exceptions can have four different time periods:

- Specific Date
e.g. Christmas Eve or 5.5., the whole of May, or the whole year of 2004
- Date Range
e.g. Summer holidays from 29.7-7.9.2004
- Recurring Event
e.g. every last Friday of every month
- Calendar Reference
A project-wide calendar provides dates, e.g. regional holidays and public/religious festivals or any other particular date. The time period can be a specific date, a date range or a recurring event.

Calendars Calendars are assigned to a whole project. They contain exception days or periods, e.g. Christmas, holidays.

If controller schedules are referring to the same calendar(s), project wide scheduling is possible for these controllers, because calendar dates are executed in each controller of the project, which has references to the calendar. Changes in multiple particular controller schedules can be quickly made by simply changing the referenced calendar(s).

Switchpoints / Switched Properties

By default, the property 'present value' is assigned to a datapoint. Hence, when switching a datapoint, the present value of the datapoint is switched. This is the standard case. In addition, in enhanced case, multiple datapoints and or other properties than the present value can be switched.

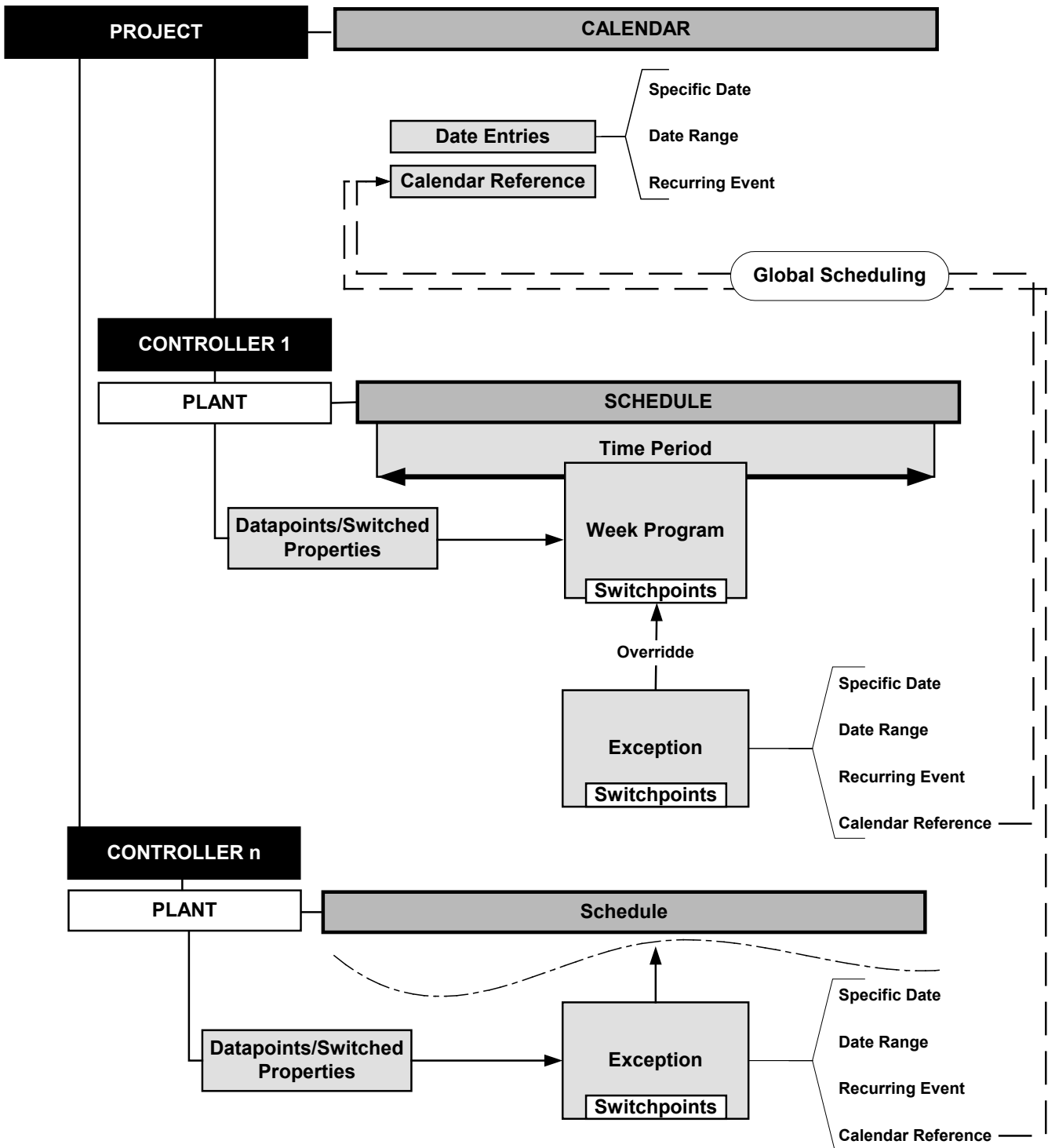

Fig. 20. Schedules and Calendars

TRENDING

Trending Trending can be performed via the Excel Web II HTML Interface residing on any PC platform and via BACnet clients. Trend data is stored on the integrated Flash via "Trend-log" objects. 3 Trend-log objects are set up by default for the BACnet and LON statistics in the Excel Web II controller. 497 trend objects can be set up freely. Per Trend-log object 10.000 trend records can be stored on the integrated Flash. Trend data storage can be in 'Ringbuffer' mode or in 'Stop When Full' mode. Trend data are dynamically created in the controller and can be saved and downloaded as a .CSV file

Trend data have unlimited lifetime and survive a firmware download under the following precondition:

- The trend object(s) must have been active at least 80 seconds before a firmware download is executed, because only every 80 seconds online changes like trends are saved into the Flash memory

Trend objects must be explicitly deleted via Eagle Web Interface or BACnet. This deletes also the corresponding trend records. The trended object may be a local or a reference point in the same controller and the trended property may be integer or floating point, e.g. point value, point state, alarm limit, time stamp.

PLANTS

The Eagle application can comprise several plants. This is defined in the CARE programming tool.

Plants are typically defined to match the controlled application, e.g. Air Conditioning Plant, Boiler Room, Chillers, etc.

On plant level you can shutdown and restart the application which is running in the corresponding controller. This is possible via the Eagle Web Interface and via BACnet. In the Eagle Web Interface also the latest start and stop date is displayed.

CONTROL LOOPS

The data processing of the controller is programmed in control loops. Authorized users, using the CARE software, define them. A control loop receives the input values from sensors and other hardware or software components. The controller calculates with these values and determines if a regulation is necessary. In such a case, the controller initiates the predefined reaction by switching the connected hardware or software.

There are three types of control loop functions:

- **Functions**
Functions are basic logic elements with which you can build macros. They cannot be created, edited or removed.
- **Macros in a plant**
Macros are software modules programmed from functions. Macros in a plant are available in a single plant. It is up to the user to create, edit or remove such macros. The same macro can be used many times in a plant. If a macro in a plant is changed, the macro change will appear in all instances of the macro in this plant, but not in other plants.
- **System Macros**
Honeywell provides system Macros. They are available for all projects of the Database. These macros are protected against editing and removing.
- **Library Macros**

Library Macros are project independent macros created by the user. The same macro can be used many times in a library. If a macro in a library is changed, the macro change will appear in all instances of the macro in this library, but not in other libraries.

Parameters

Parameters are used for configuration and tuning of the application program via control loops. A typical example of a parameter is the Integral Time of the PID control function.

Parameters are part of a control icon which itself is part of a control loop which itself is part of a plant, etc. Hence, the parameter can be described and addressed by its path as follows:

plant – control loop – control macro - control icon – parameter

Example: airconditioning.contloop1.supply_temp.integral time

A parameter is defined by:

- Name
- Value
- Engineering unit/state text (in the Eagle Web Interface only supported for control macros, not for control functions)

Cycle Time Category

The cycle time category defines the time in ms after a control loop is restarted automatically. To view/set cycle time categories, please refer to the "View/Change Cycle Time Categories" section.

SYSTEM SETTINGS

System settings include the following settings:

- System date, time and time zone
- Cycle time category (see also "Cycle Time Category" section).
- Communication settings

Communication Settings

Communication settings include:

- Interface settings for Ethernet, LON, and Web-Server, such as IP address, neuron chip ID, automatic logout time of web server
- User name and password definition
- Selection of remote front-end
- Dial out parameter (re-dial algorithm) definition

Diagnostics

Diagnostics allow trending and display of LON specific parameters such as:

- Transmission errors
- Lost messages
- Collisions
- Etc.

For trending LON parameters, basic settings such as start and stop time, trend buffer values and enable/disable logging are defined.

Diagnostics also allow BACnet diagnostic (MS/TP statistics) by showing the actual communication status on the BACnet bus and search for BACnet objects and identifiers.

EMAIL ALARMING

Purpose Sending an email to a definable email-recipient in case of alarms of selectable datapoints. Alarms may be generated for each datapoint that has the appropriate notification class assigned and the alarm reporting enabled. The email includes an attachment (.TXT) that shows a detailed description of the alarm data, for example:

```
Democase_Controller
http://192.168.200.10
URGENT (193)
Outdoor_Temperature
2008-March-12 We 14:29:16
Notify Type: Alarm
Event Type: Out Of Range
Description: Smart_IO_AI2
Present Value: 50 °C
Low Limit: 3 °C - High Limit: 40 °C
```

Steps Setting up the email alarming process includes the following major steps:

In CARE

- Enter E-Mail alarming properties
- Connect to controller
- Translate and download application
- Download controller settings

For information on the procedure, please refer to the CARE User Guide, EN2Z-0970GE51.

In the Eagle Web Interface

1. Assign email address to the user that receives the alarm email(s) (recipient)
2. Assign email address (recipient) to the notification class
3. Define alarming conditions for datapoint(s) that should send alarm emails
4. Send Test Email

NOTE: Steps 1 through 3 can also be done in CARE

For detailed information on the procedure, please refer to "Email Alarming" in the "Operating the Eagle Web Interface" section.

EVENT ENROLLMENTS

Event Enrollment Objects / Algorithmic Change Reporting

Event Enrollment Objects

The primary purpose for Event Enrollment objects is to define an event and to provide a connection between the occurrence of an event and the transmission of a notification message to one or more recipients.

The Event Enrollment object contains the event-type description, the parameters needed to determine if the event has occurred (Algorithmic Change Reporting), and a device to be notified. Alternatively, a Notification Class object may serve to identify the recipients of event notifications. A device is considered to be "enrolled for event

notification" if it is the recipient to be notified or one of the recipients in a Notification Class object referenced by the Event Enrollment object. Event Enrollment objects are the basics for algorithmic change reporting.

Algorithmic Change Reporting

Algorithmic change reporting enables a BACnet device to provide one or more alarm or event sources, defined by Event Enrollment objects, to generate alarm or event notifications that may be directed to one or more recipients. Any of the standardized algorithms may be used to establish criteria for change reporting. Once established, occurrences of change may be reported to one or more recipients based on further criteria. Changes of value of specific properties of an object may be programmed to trigger event notifications to be sent to one or more recipients based on a notification class. Typically, event notifications are sent to application programs represented by processes within a notification-client device. The object(s) whose properties are referred to is known as the Reference Object(s). The criteria used to ascertain that an event has occurred are determined by the Event Type, for example, CHANGE OF BITSTRING, CHANGE OF STATE etc.

The Eagle Web Interface allows enabling event enrollments for

- Plant
See "Enable Event Enrollment Alarming for Plant" in the "Operating the Eagle Web Interface" section.
- Controller
See "Enable Event Enrollment Alarming for Controller System Status" in the "Operating the Eagle Web Interface" section.
- Datapoints
See "View / Edit Event Enrollment Alarming" in the "Operating the Eagle Web Interface" section.
- Email alarming
See "Enable Event Enrollment Alarming for Controller Email Alarming" in the "Operating the Eagle Web Interface" section.

OPERATING THE EAGLE WEB INTERFACE

Start Eagle Web Interface

Prerequisites The PC platform hosting the Eagle Web Interface must be physically connected to the controller as described under "Access Modes to Eagle Controller" in the "System Overview" section.

Procedure 1. Start your web browser

NOTE: Depending on the CARE IP port settings (see "Define BACnet IP Bus Properties" section in the CARE User Guide), you are logging in via HTTP (Port 80 enabled) or via HTTPS (ports 80 and 443 enabled). When logging in via HTTPS, please refer to the subsequent "Login via HTTPS" section after finishing with this section.

2. In the address field of the web browser, enter the IP address of the controller you want to operate.

RESULT: The Login page is displayed.

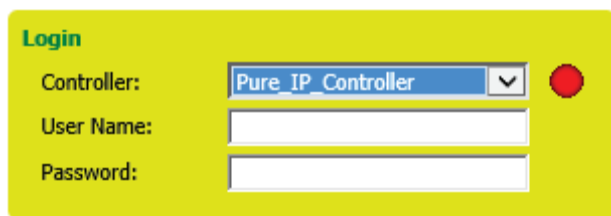

3. From the **Controller** drop-down listbox, select the controller. Any controller that has alarms is red colored and blue highlighted. The alarm indicator icon shows whether alarms are on the BACnet bus (red) or not (green).

4. In the **User Name** field, enter your user name, or select the user name from the drop-down listbox (only selectable if the **Enable Comfortable Login** option was enabled in the CARE project, see also step 6).

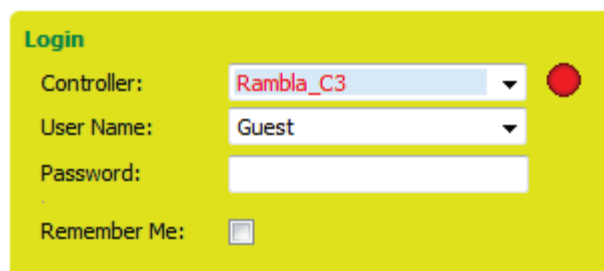

5. In the **Password** field, enter your password.

NOTE: For the user 'Guest' or 'guest', login is no longer possible using the unsecure passwords 'Guest' or 'guest' or blanks (no password).

6. If the **Enable Comfortable Login** option was enabled in the CARE project, the **Remember Me** check box is available. Check this option if you want to login next time without the necessity to enter user name and password again.

! CAUTION

If checked, make sure that the controller is operated in a closed network or VPN to avoid misuse through cyber attacks or easy login by other persons not knowing your password and user name.

7. Click the LOGIN button.

RESULT: The *Main* screen of the Eagle Web Interface displays.

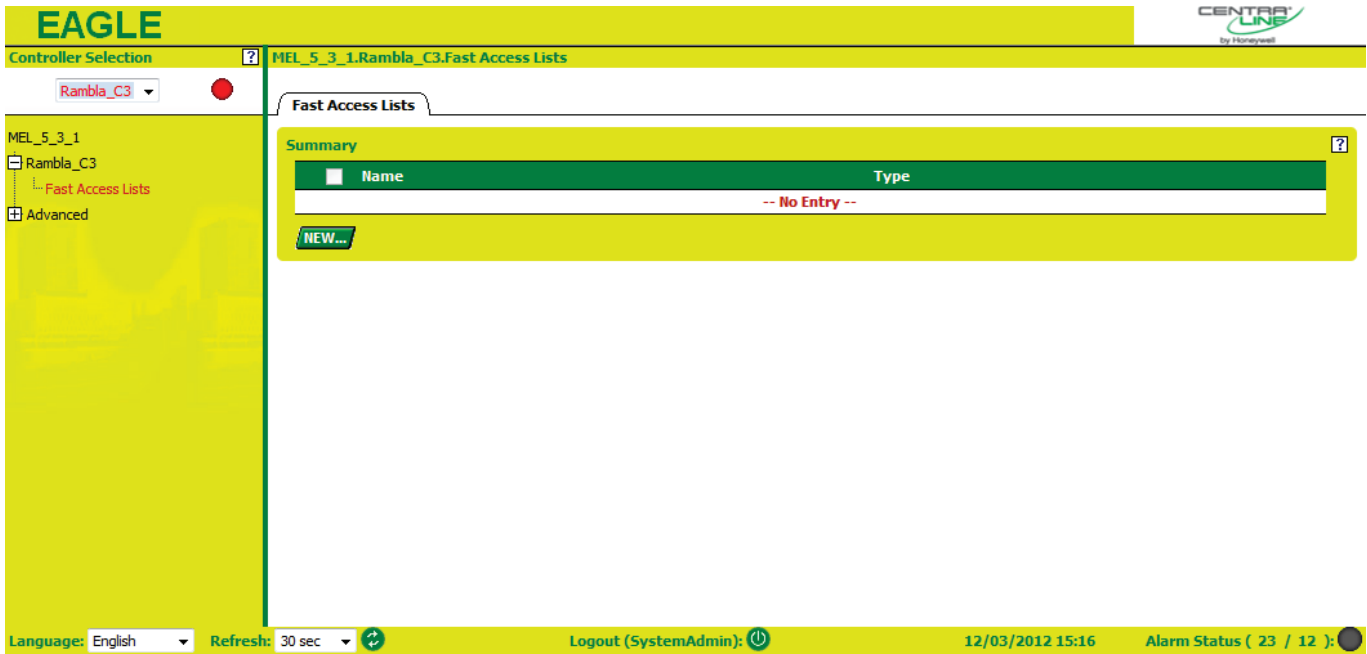

Login Retry Limits

Browser login retry limit

60 sec wait time after five wrong inputs.

If an input (correct or false) is done during the 60 sec wait time, 60 sec wait-time starts again.

FTP login retry limit

300 sec wait time after five wrong inputs.

Login via HTTPS

With CARE 10.05.00 and higher you can define a certificate for the Excel Web II controller and download it into the Excel Web II. A certificate allows communication via the HTTPS standard which provides a higher cyber security level for communication.

SECURITY NOTICE!

These certificates are self-defined end-entity certificates, which the Excel Web II is signing and hence are insecure and not comparable to trusted certificates from certification authorities.

When accessing the controller via web browser, there are 4 options how certificates are applied and handled:

HTTPS

Trusted CA-signed certificates

Use of IP ports 443 and 80. Automatic re-direct to HTTPS. Recommended. .

SECURITY NOTICE!

This kind of certificate is recommended for internet facing controllers

Self-signed controller certificates

Use of IP ports 443 and 80. Automatic re-direct to HTTPS.

Self-signed root certificate and derived controller certificates

Use of IP ports 443 and 80. Automatic re-direct to HTTPS.

SECURITY NOTICE!

Self-signed certificates must not be used for internet-facing controllers, because they are not secure. Users may consider using self-signed certificates in secured networks, like VPN or closed networks, based on their own security assessment.

HTTP Use of IP port 80. Non-repudiation. Not recommended, but HTTP is necessary for special HTTP access solutions, that are not using web-browsers and therefore cannot handle certificates.

Depending on the used browser, the steps are different when working with certificates.

In the following, the HTTPS options are described.

Trusted CA-signed Certificates**SECURITY NOTICE!**

This kind of certificate is recommended for internet facing controllers.

- Procedure**
1. Setup a full qualified domain name for the controller, e.g. CPU1.customer.com. This is typically done by applying your own dynamic DNS server.
 2. Organize the CA certificate from the certification authority which includes the following tasks:
 - a. Create CSR = Certificate Signing Request
 - b. Answer verification email (domain validation)
 - c. Receive certificate & private key
 3. Access the controller via browser login using HTTPS.
 4. Install the CA certificate via browser (see "Web Server Certificates" section). This includes:
 - CA intermediate certificate + controller certificate + private Key

NOTE: Because the web browser connection is not secure at the time of the installation (download), it is recommended to access the browser via the local USB-B port connection of the controller.

For further detailed information on CA-signed certificate handling, please refer to common literature about Certificates, e.g. the X.509 cryptography standard.

Self-signed Controller Certificates**SECURITY NOTICE!**

Self-signed certificates must not be used for internet-facing controllers, because they are not secure. Users may consider using self-signed certificates in secured networks, like VPN or closed networks, based on their own security assessment.

Self-signed controller certificates are handled in one of the following ways:

- Certificate automatically created at controller start-up. The application with IP address must be loaded.

- Certificate information is defined in CARE. The information must be that of the network domain owner.
- Certificate created using any OpenSSL tool (e.g. XCA). The certificate consists of a private key, root certificate and a derived certificate. The root certificate must be imported into the web browser. The derived certificate must be downloaded into the controller.

NOTE: Because the web browser connection is not secure at the time of the download, it is recommended to access the browser via the local USB connection of the controller.

Procedure

1. In CARE, create the certificate. This triggers the controller to create the certificate and the private key.

2. Access the controller via browser login using HTTPS.

RESULT: The web browser does not accept the self-signed certificate and displays a warning. You must accept and install an untrusted certificate.

3. Accept the warning and install the untrusted certificate.

RESULT: The behavior and URL display depends on the used browser and its version. But, in every case, HTTPS communication will be established and encryption is enabled.

4. In the following, for Internet Explorer, Chrome and Firefox.

Internet Explorer Browser and Self-signed Certificates Handling

When the following message displays in Internet Explorer after login, click **Continue to this website (not recommended)**.

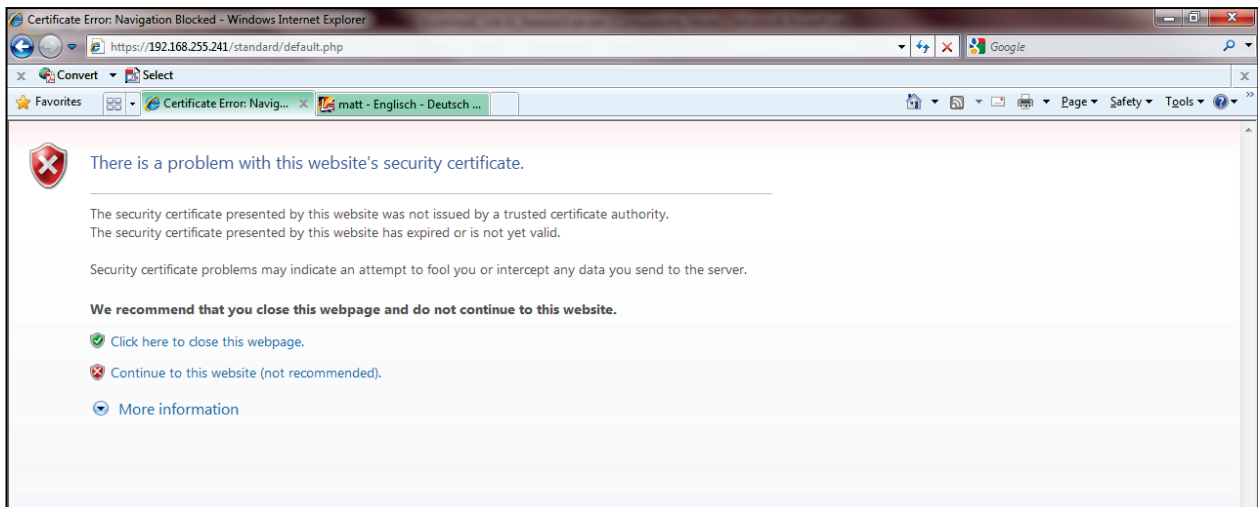

In the following screen, click **View certificates**.

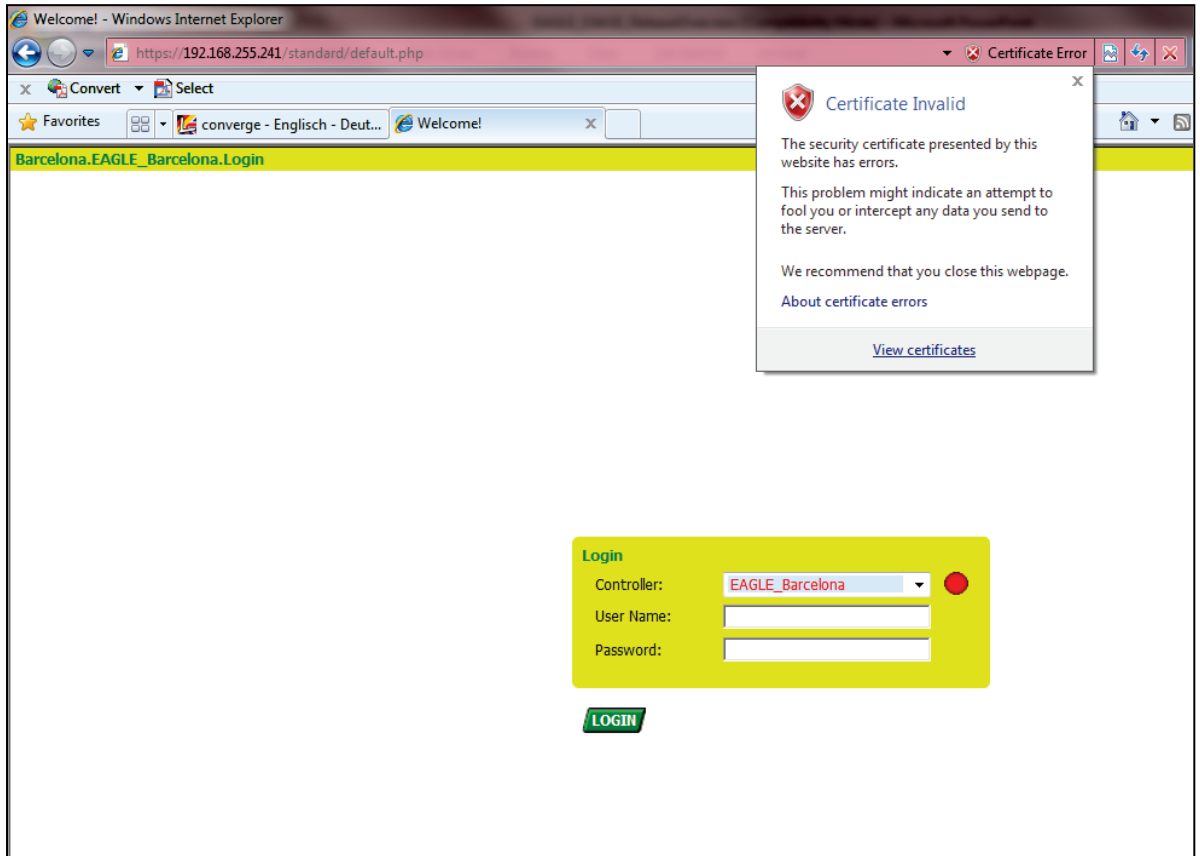

In the Certificate dialog box, click **Install Certificate**.

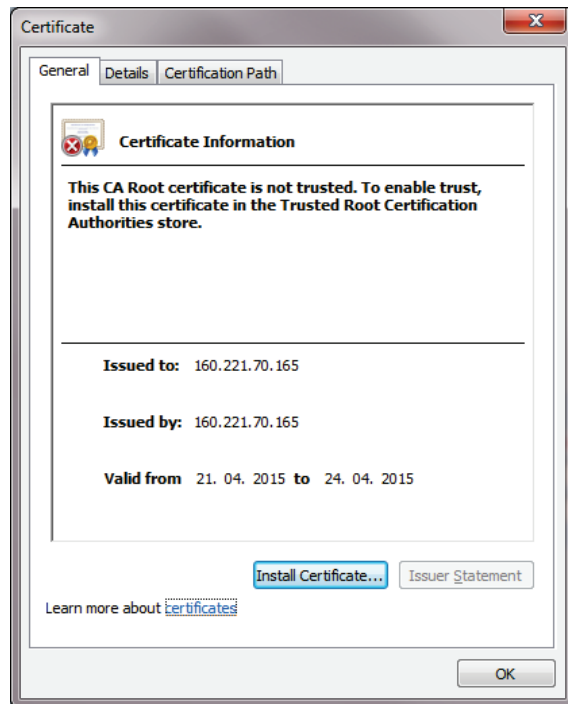

Confirm the following message box by clicking **OK**.

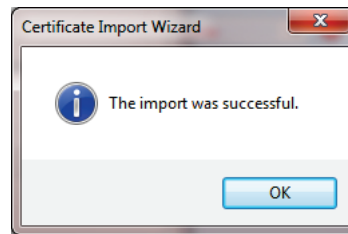

After successful import, the "Certificate Error" warning remains and the URL is displayed in red.

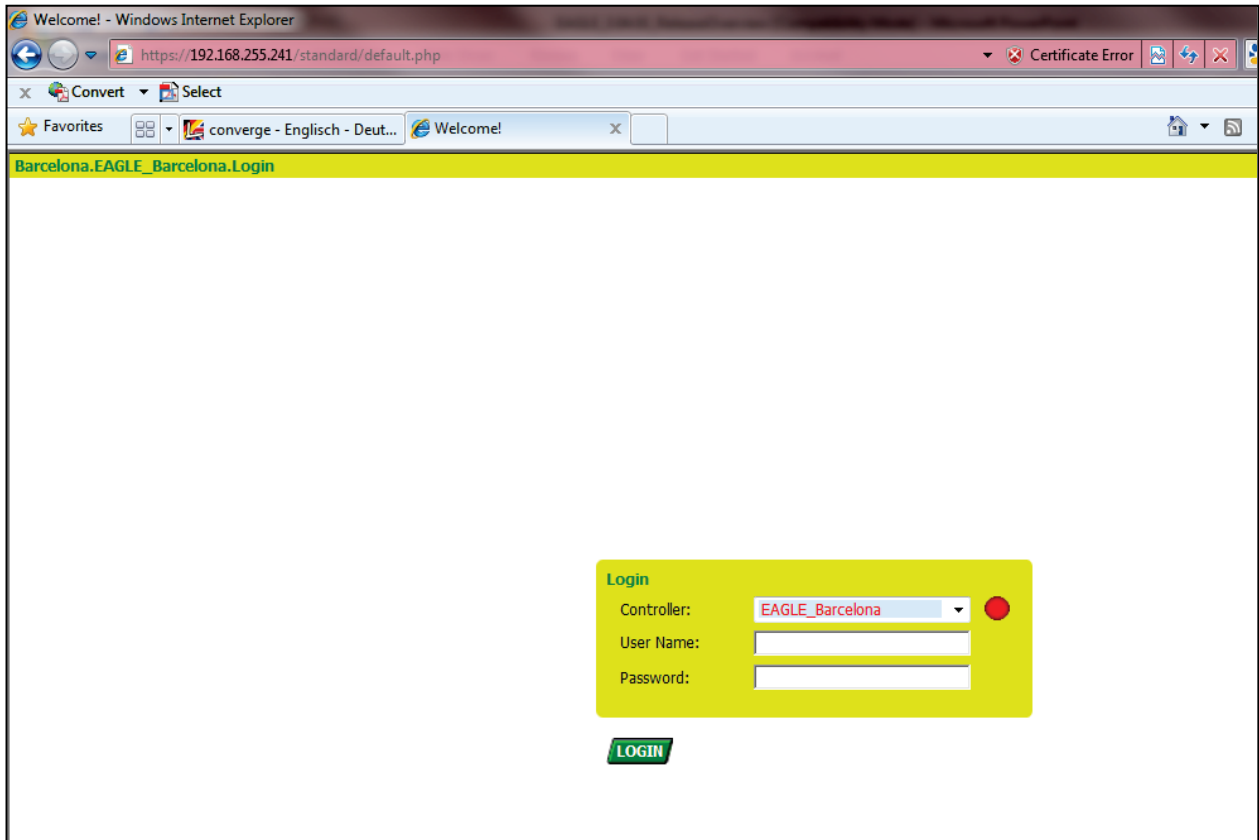

Chrome Browser and Self-signed Certificates Handling

When the following message displays in Chrome after login, click **Advanced**.

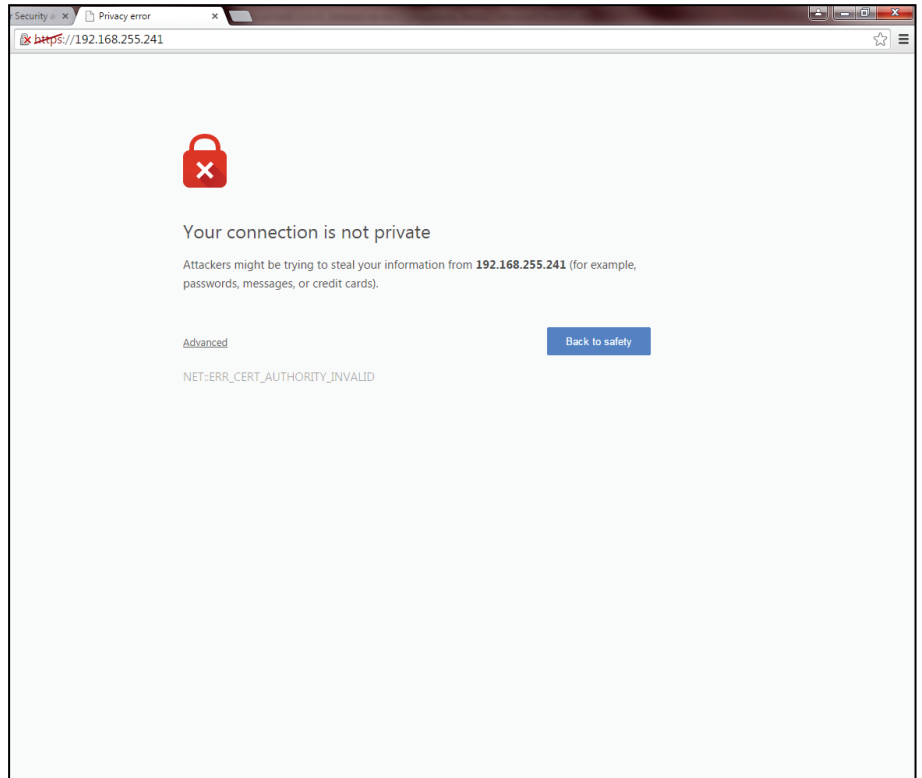

In the following screen, click **Proceed to <IP address> (unsafe)**.

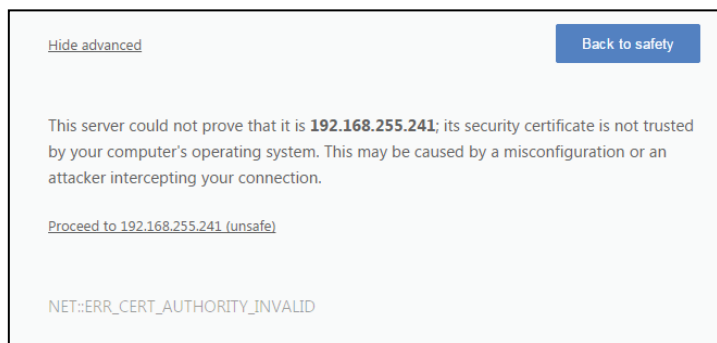

In the address line, the warning remains after acknowledgement. The URL displays "disabled https in red" but encryption is working.

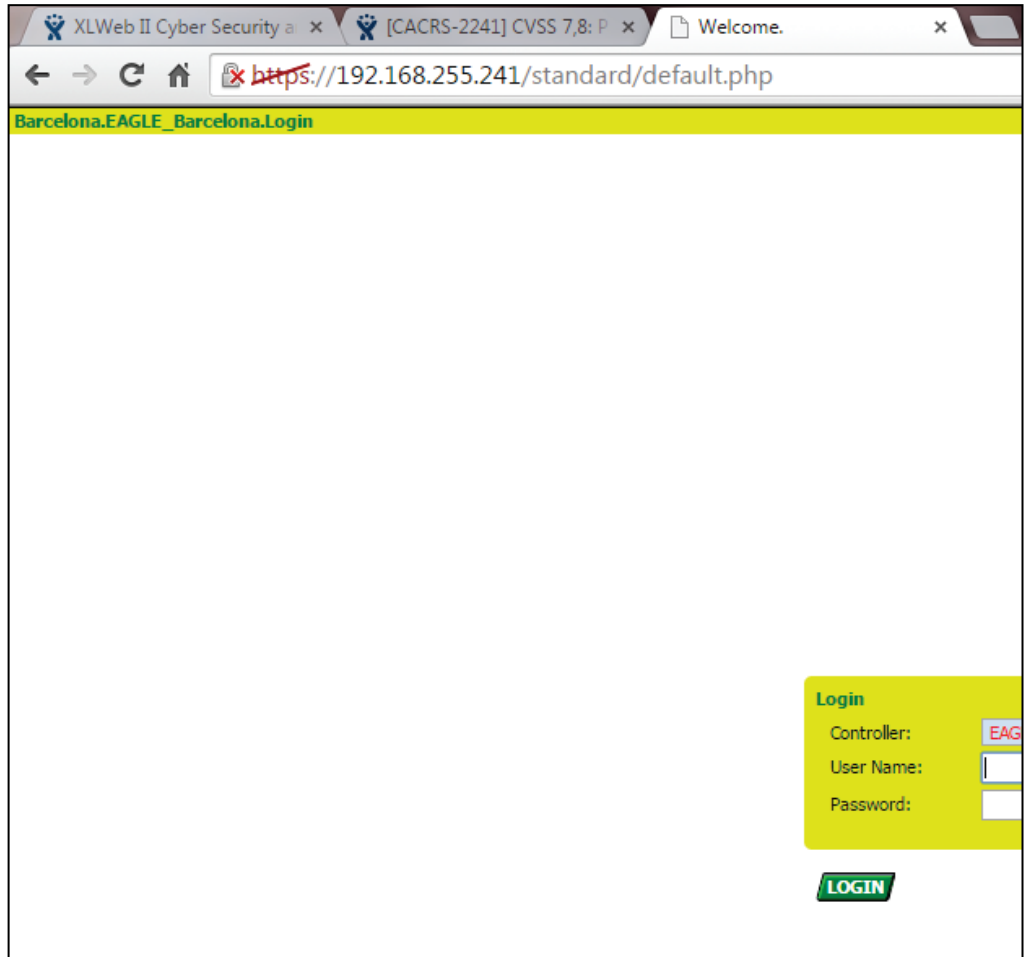

Firefox Browser and Self-signed Certificates Handling

When the following message displays in Firefox after login, click **I Understand the Risks**.

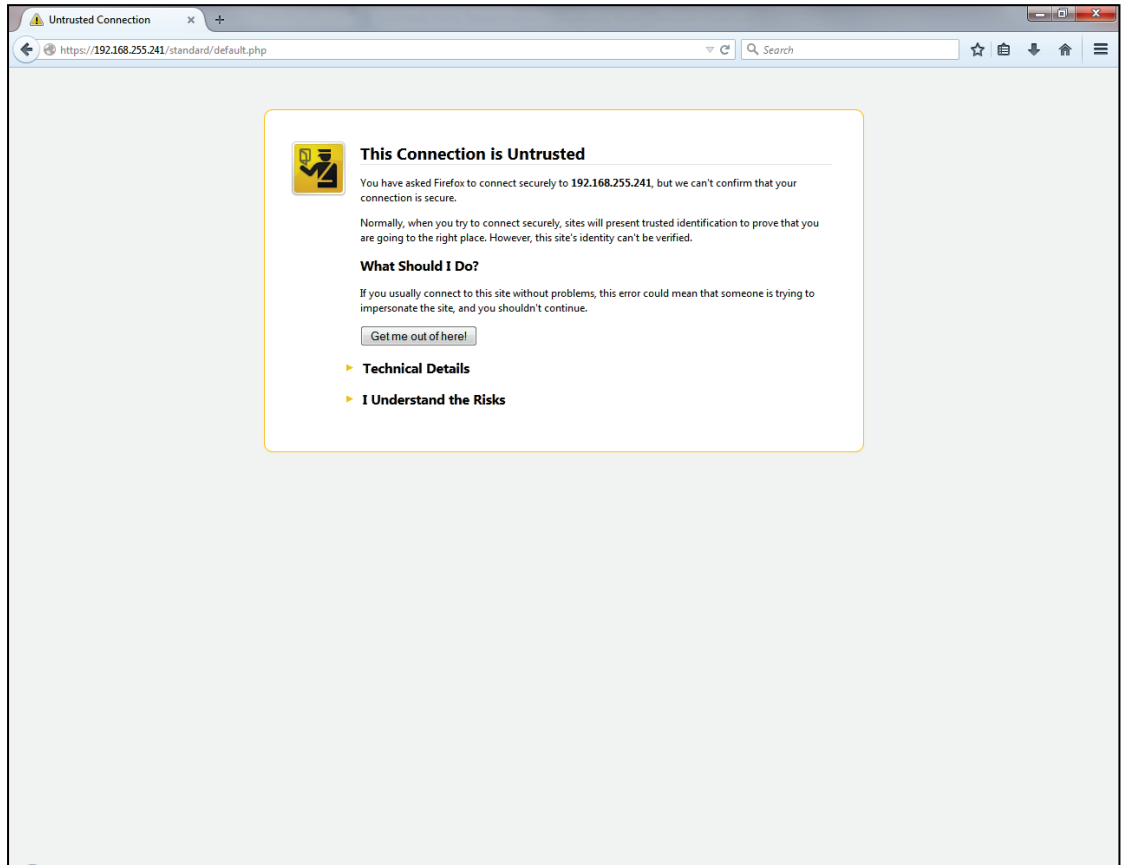

In the following screen, click **Add Exception**.

▼ **Technical Details**

192.168.255.241 uses an invalid security certificate.

The certificate is not trusted because it is self-signed.

(Error code: sec_error_unknown_issuer)

▼ **I Understand the Risks**

If you understand what's going on, you can tell Firefox to start trusting this site's identification. **Even if you trust the site, this error could mean that someone is tampering with your connection.**

Don't add an exception unless you know there's a good reason why this site doesn't use trusted identification.

Add Exception...

In the Add Security Exception dialog box, click **Get Certificate**, and select the certificate.

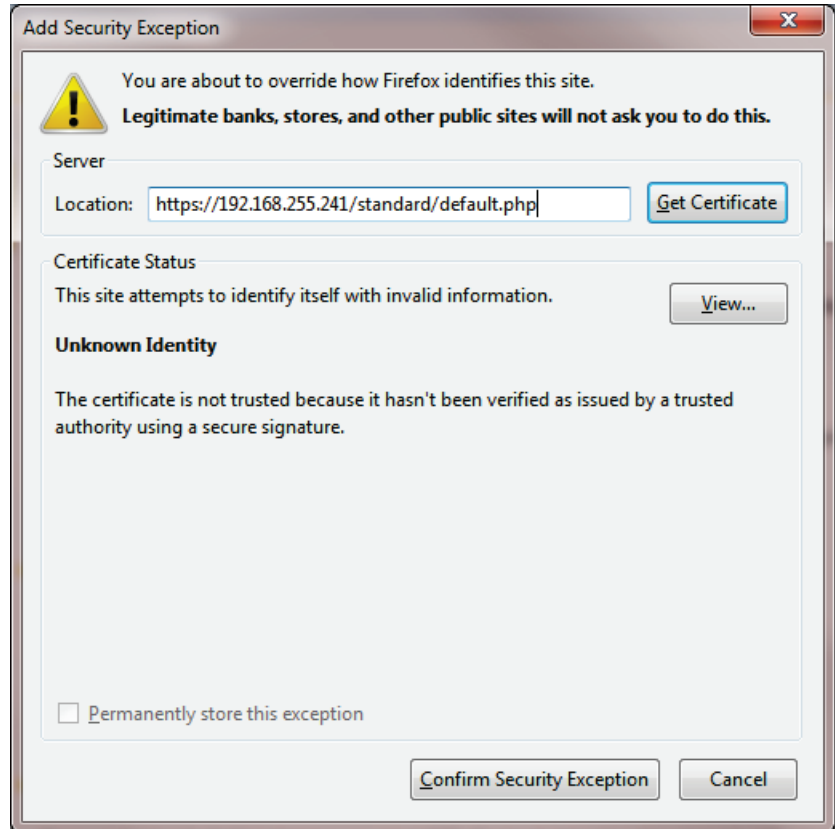

Then, confirm by clicking **Confirm Security Exception**.



After successful addition, the URL displays "https" on white background.

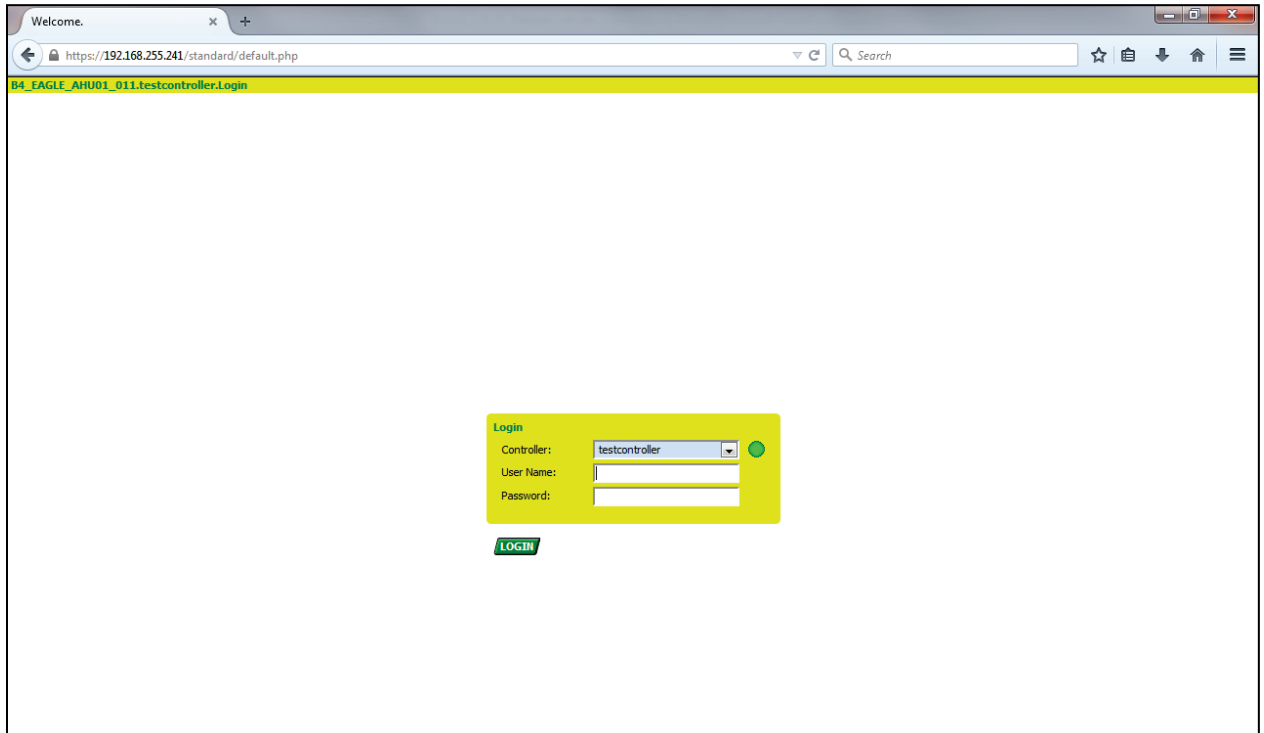

Self-signed Root Certificate and Derived Controller Certificates

SECURITY NOTICE!

Self-signed certificates must not be used for internet-facing controllers, because they are not secure. Users may consider using self-signed certificates in secured networks, like VPN or closed networks, based on their own security assessment.

Procedure

1. By using an OpenSSL Tool (e.g. XCA), create a root certificate and derived certificate(s) for the controller(s).
2. Download the derived certificate(s) and the private key into the controller(s).
3. Download the root certificate into the web browser.
4. Access the controller via browser login using HTTPS.

RESULT: HTTPs communication will be established without warning.

User Tasks Overview for Different Certificates

The following table shows the various tasks to be done by the user dependant on the applied certificates.

	CA-Certificate	Self-Signed Certificate	Self-Signed Root Certificate and Derived Controller Certificates
		MUST NOT BE USER FOR INTERNET FACING CONTROLLERS!	
First browser contact to controller			
New controller, or controller upgrade	Domain Owner: Organize controller certificate and download it into controller	CARE User: Create controller certificate	Web User: Acknowledge risk warning Import certificate into browser
Changed controller IP address			
Certificate expired			
Controller private key compromised			
			Domain Owner: Create root certificate and derived controller certificates Download certificates into controller and browser

Main Screen Description and Basic Functions

Main Screen Description

The *Main* screen provides two basic panes, the controller selection pane and the information and editing pane (see next page).

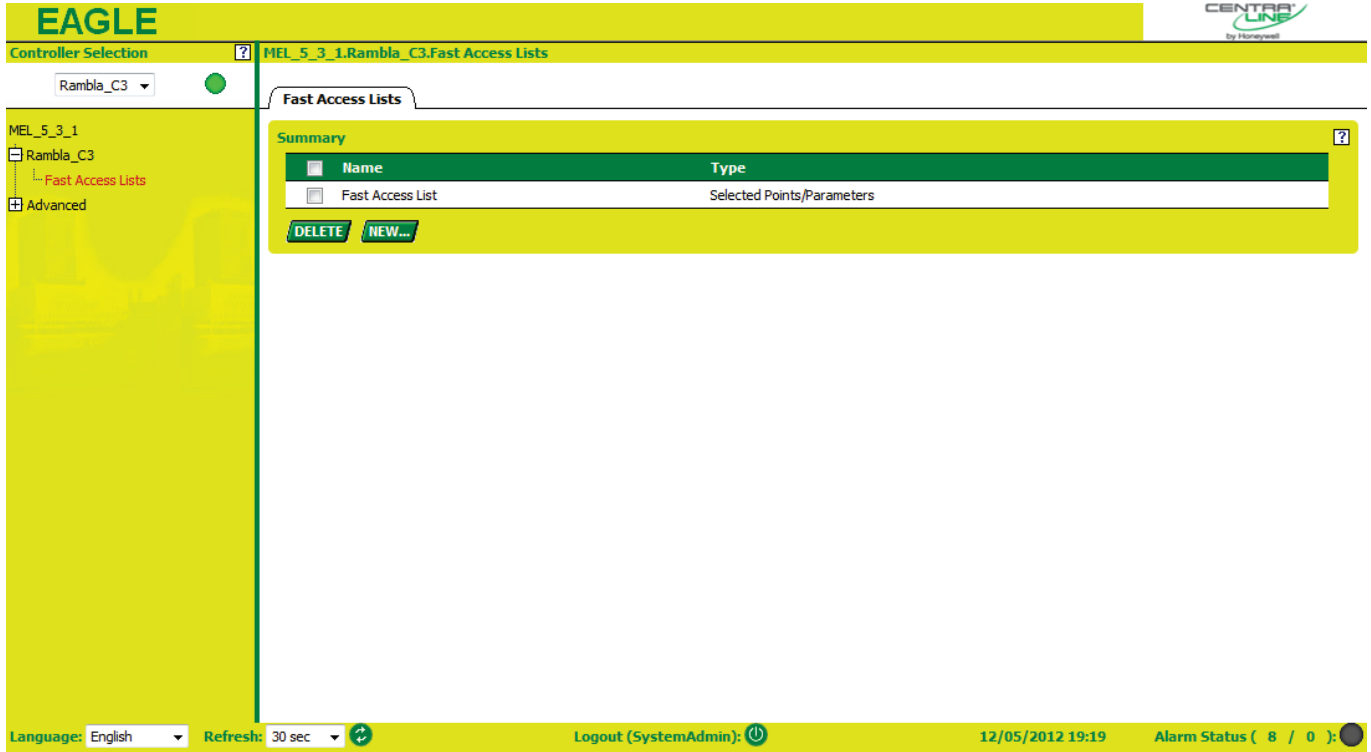

Controller Selection Pane (see next page)

The controller selection pane on the left (in the following just named tree) displays the application of the current controller in a hierarchical tree structure. From the Controller Selection drop-down list on the top, the controller can be selected among all controllers residing on the network. Any controller which has alarms is marked in red. The alarm indicator icon next to the drop-down listbox indicates whether alarms exist (red) on the BACnet bus or not (green).

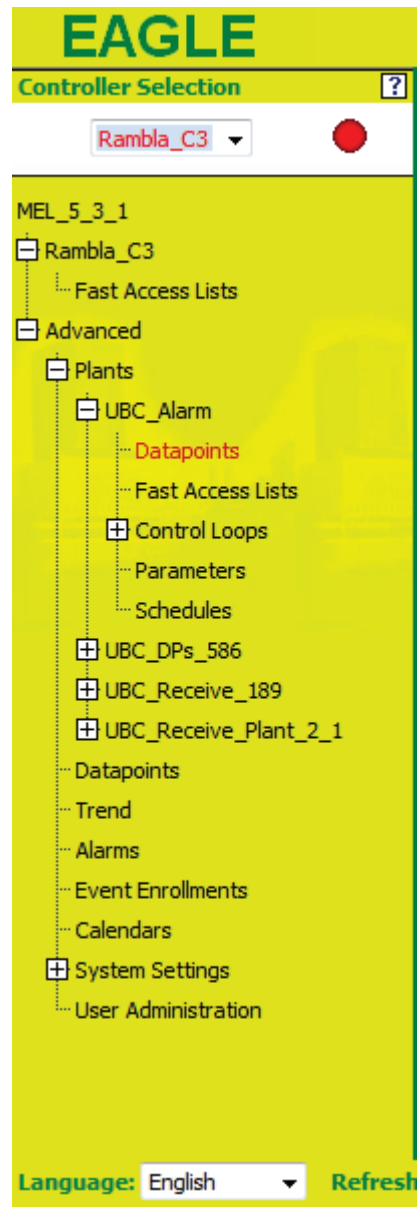

Information and Editing Pane (see next page)

The right pane shows the properties of the selected item, which may look very different depending on the selected item. For example, it may show project information, a datapoint list, or any of the details of the Advanced tree.

Datapoints

Datapoint Filter ▲▼ ?

Plant: Points in Alarm Points in Manual

Type:

<input type="checkbox"/> All Types	<input checked="" type="checkbox"/> Analog Input (AI)	<input checked="" type="checkbox"/> Binary Input (BI)	<input checked="" type="checkbox"/> Multi-State Input (MI)	<input checked="" type="checkbox"/> Pulse Converter (PC)	<input type="checkbox"/> Reference Input (RI)
<input checked="" type="checkbox"/> Analog Output (AO)	<input checked="" type="checkbox"/> Binary Output (BO)	<input checked="" type="checkbox"/> Multi-State Output (MO)	<input type="checkbox"/> Reference Output (RO)		
<input checked="" type="checkbox"/> Analog Value (AV)	<input checked="" type="checkbox"/> Binary Value (BV)	<input checked="" type="checkbox"/> Multi-State Value (MV)	<input type="checkbox"/> Flag Point (FP)		

Name: GO

Datapoint List ?

Sort by: Entries per Page: 50 ▼

Name	Description	Value/Unit	Event State	Type	ALM	FLT	OVR	OOS
UBC_A1		8.00 V	Normal	AI	<input type="checkbox"/>	<input type="checkbox"/>	<input type="checkbox"/>	<input checked="" type="checkbox"/>
UBC_AI2		9.00 V	Normal	AI	<input type="checkbox"/>	<input type="checkbox"/>	<input type="checkbox"/>	<input checked="" type="checkbox"/>
UBC_AITemp		0.00 °C	Fault	AI	<input checked="" type="checkbox"/>	<input checked="" type="checkbox"/>	<input type="checkbox"/>	<input type="checkbox"/>
UBC_AI_xlweb2_188_1		8.92 V	Normal	AI	<input type="checkbox"/>	<input type="checkbox"/>	<input type="checkbox"/>	<input type="checkbox"/>
UBC_AI_xlweb2_188_2		8.91 V	Normal	AI	<input type="checkbox"/>	<input type="checkbox"/>	<input type="checkbox"/>	<input type="checkbox"/>
UBC_AO_Alarm_1		12.00 %	Normal	AO	<input type="checkbox"/>	<input type="checkbox"/>	<input checked="" type="checkbox"/>	<input type="checkbox"/>
UBC_AO_Alarm_2		0.00 %	Low Limit	AO	<input checked="" type="checkbox"/>	<input type="checkbox"/>	<input type="checkbox"/>	<input type="checkbox"/>
UBC_AO_SpaceTemp		1.00 °C	Normal	AO	<input type="checkbox"/>	<input type="checkbox"/>	<input type="checkbox"/>	<input type="checkbox"/>
UBC_AO_xlweb2_188_1		100.00 %	Normal	AO	<input type="checkbox"/>	<input type="checkbox"/>	<input type="checkbox"/>	<input type="checkbox"/>
UBC_AO_xlweb2_188_2		100.00 %	Normal	AO	<input type="checkbox"/>	<input type="checkbox"/>	<input type="checkbox"/>	<input type="checkbox"/>
UBC_AV_Alarm_1		0.00 K	Low Limit	AV	<input checked="" type="checkbox"/>	<input type="checkbox"/>	<input type="checkbox"/>	<input type="checkbox"/>
UBC_AV_Alarm_2		0.00 K	Low Limit	AV	<input checked="" type="checkbox"/>	<input type="checkbox"/>	<input type="checkbox"/>	<input type="checkbox"/>
UBC_AV_Cycle_Ramp_Off_Time		300.00	Normal	AV	<input type="checkbox"/>	<input type="checkbox"/>	<input type="checkbox"/>	<input type="checkbox"/>
UBC_AV_Cycle_Ramp_On_Time		300.00	Normal	AV	<input type="checkbox"/>	<input type="checkbox"/>	<input type="checkbox"/>	<input type="checkbox"/>

30 sec Logout (SystemAdmin): 12/05/2012 19:22 Alarm Status (8 / 9)

Sizing the Pane Displays

The size of the pane display can be varied by moving the red separator horizontally to the left or right.

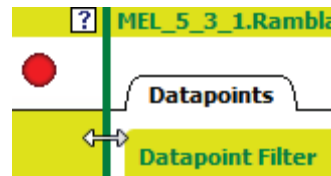

Tree Navigation

You can navigate through the tree by clicking on tree items, or by clicking the plus-/minus icons at the tree items.

Viewing and Editing Information

To view or edit data and properties of an item, select an item by clicking on the item in the tree.

On the right pane, the corresponding data and properties of the selected item are displayed. In the tree, the selected item is marked red.

In the headline, the path (separated by dots) of the selected item is displayed.

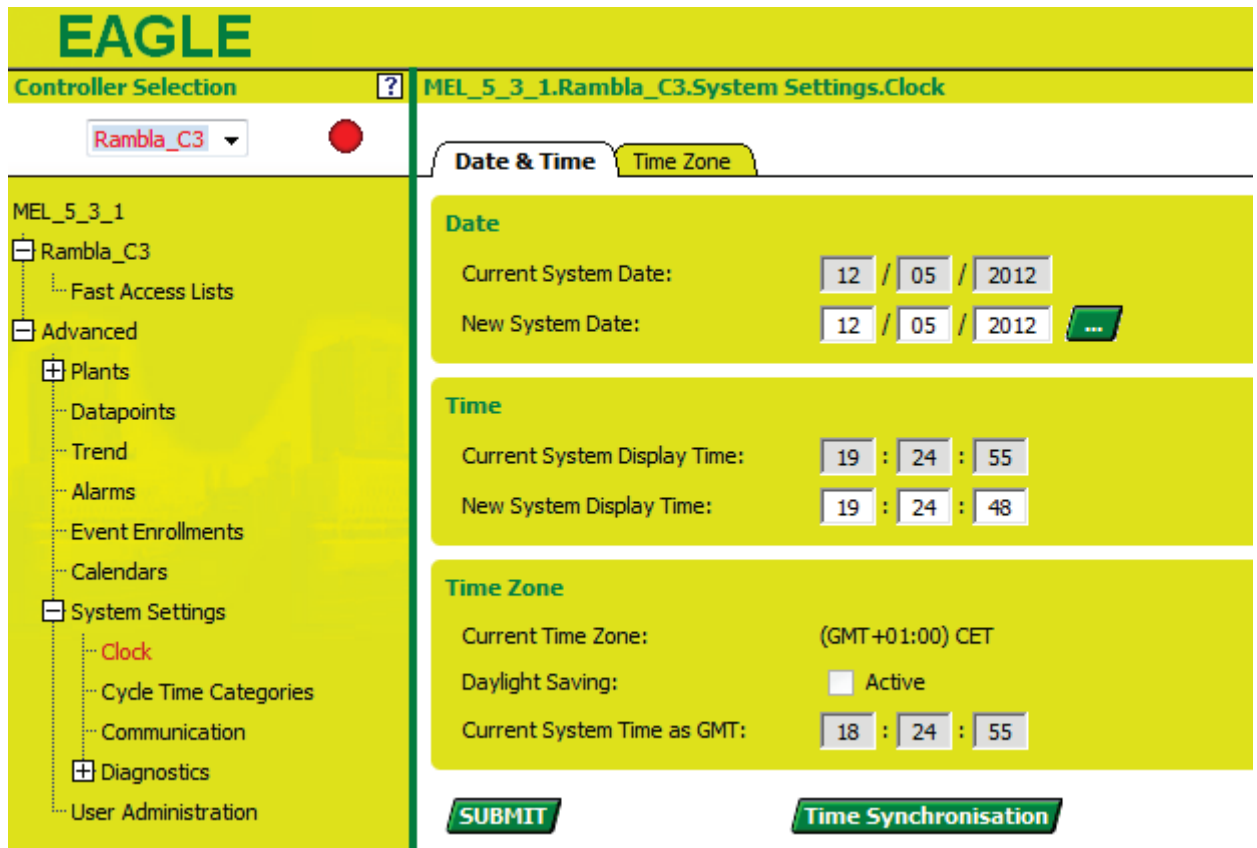

NOTE: Some items, for example 'Advanced' may not have properties and data for display on the right pane.

Footer

In the footer on the bottom the following functions are available:



Language

From the **Language** drop-down list box, select the language the Eagle application should use.

If a language is missing, please ask you Honeywell representative if your desired language can be provided.

Refresh

From the **Refresh** drop-down list box, select the value for automatically refreshing data in the Eagle application. A manual instant refresh can be done by clicking the *Refresh* icon right from the **Refresh** drop-down list box.

NOTE: If you use the 'Refresh' command of the Internet Explorer, you will need to login in to the Eagle controller again.

Logout

By clicking the *Logout* icon, you can logout.

Date and Time display

Shows the current date and time in country-specific format

Alarm Status display

Shows the number of alarms (new/total) and the alarm status. The alarm icon on the right indicates alarms as follows:

- Blinking red = new and unviewed alarms exist
- Constantly red = alarms have been viewed but alarm conditions still exist
- Constantly green = no alarm conditions exist

The alarm numbers will only be refreshed if the **Refresh** function is active.

Context Sensitive Online Help

Clicking on the *Help* icon  displays information on the corresponding area.

Basic Functions

The properties of a selected item in the tree, for example, Fast Access Lists, are displayed on tabs on the right pane.

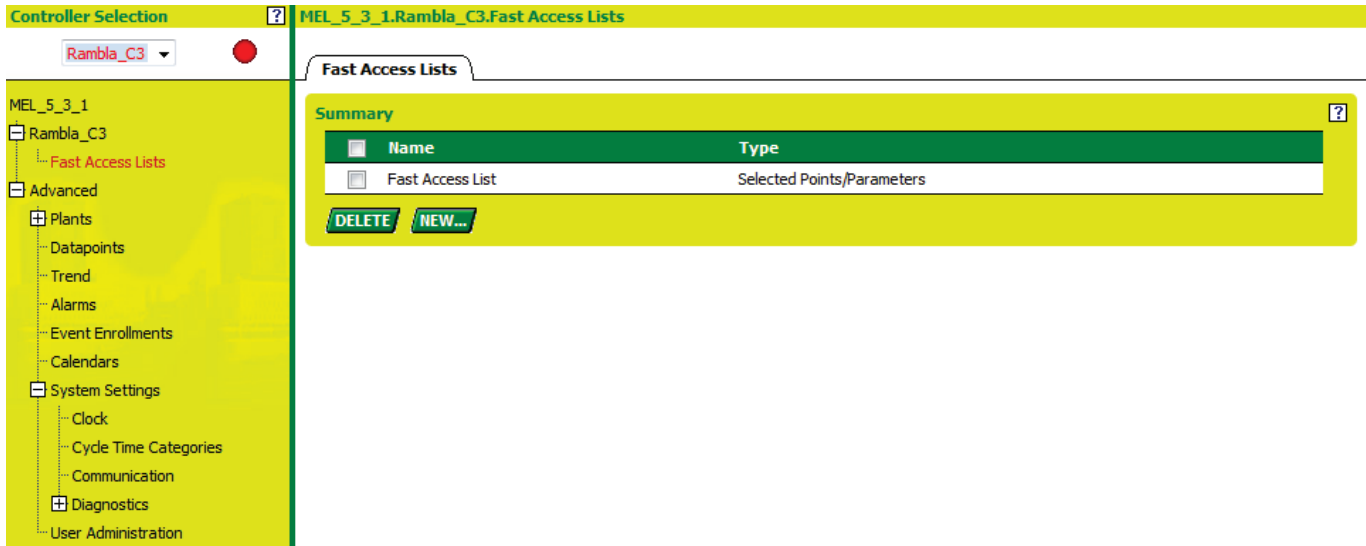

Data can be modified by clicking the appropriate buttons, such as NEW, DELETE, COPY etc.

When hovering over a list item with the mouse-cursor, the item will be highlighted in red and underlined.

A green item in a list indicates that this item links to a further dialog showing more details of the item.

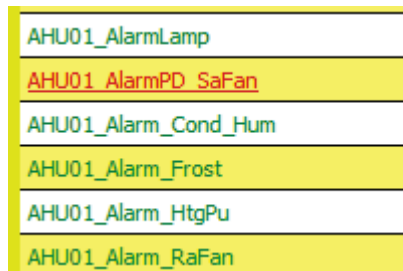

By clicking on the item, you can edit details of the selected item.

For each button, a tool tip is provided which will be visible while the cursor remains over the button for a few seconds.



Updating Data (Refresh)

The default time interval for data updates can be defined by selecting the desired value in the **Refresh** drop-down list box in the footer (see Footer description in the Main Screen Description section).

A manual instant refresh of the data can be done by clicking the *Refresh* icon right from the **Refresh** drop-down list box.

The same functionality is available in certain dialogs, e.g. in the datapoint details dialogs. In this case you can define different update intervals for several datapoint types. In addition, the manual instant refresh is possible.

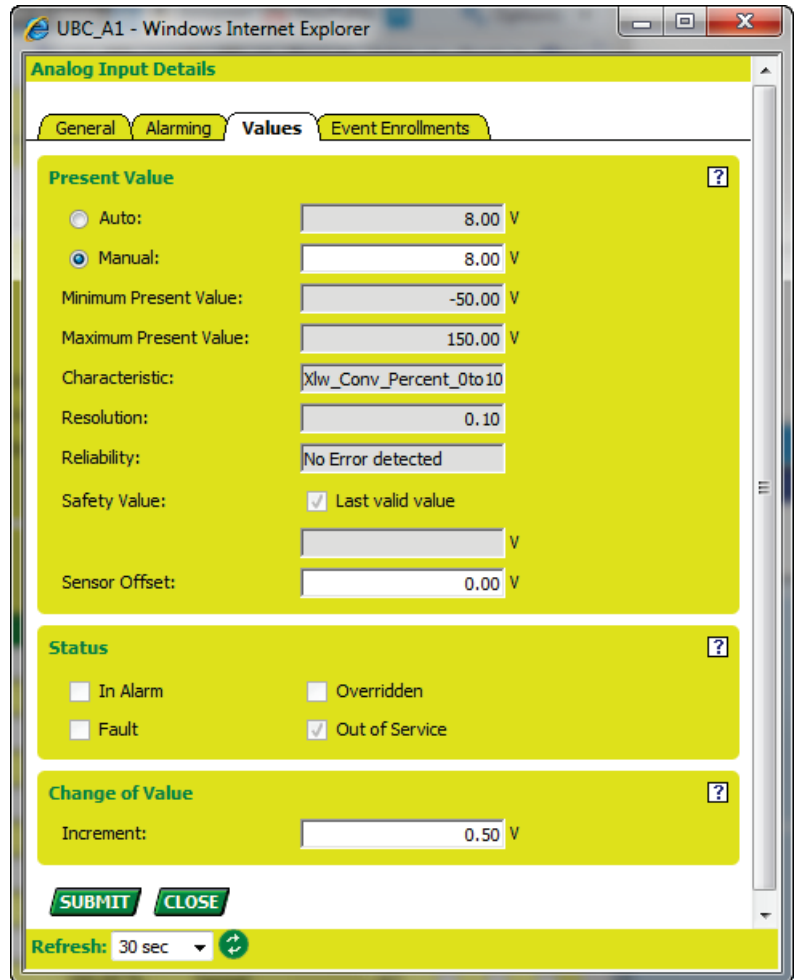

Saving Data

Saving and discarding changed data is handled by using the following buttons (dependent on the dialog):



Saves changes done in the current dialog



Discards changes done in the current dialog

Viewing / Hiding Filter Options

For datapoints, parameters, alarms, and schedules, the filter dialog options can be made visible or hidden by toggling the combined down arrow /up arrow icon

Datapoints

Datapoint Filter

Plant: Points in Alarm Points in Manual

Type:

All Types

Analog Input (AI) Binary Input (BI) Multi-State Input (MI) Pulse Converter (PC) Reference Input (RI)

Analog Output (AO) Binary Output (BO) Multi-State Output (MO) Reference Output (RO)

Analog Value (AV) Binary Value (BV) Multi-State Value (MV) Flag Point (FP)

Name:

Datapoint List

Sort by: Entries per Page: 50

Name	Description	Value/Unit	Event State	Type	ALM	FLT	OVR	OOS
UBC_A1		8.93 V	Normal	AI	<input type="checkbox"/>	<input type="checkbox"/>	<input type="checkbox"/>	<input type="checkbox"/>
UBC_AI2		8.92 V	Normal	AI	<input type="checkbox"/>	<input type="checkbox"/>	<input type="checkbox"/>	<input type="checkbox"/>
UBC_AITemp		0.00 °C	Fault	AI	<input checked="" type="checkbox"/>	<input checked="" type="checkbox"/>	<input type="checkbox"/>	<input type="checkbox"/>
UBC_AI_xlweb2_188_1		8.92 V	Normal	AI	<input type="checkbox"/>	<input type="checkbox"/>	<input type="checkbox"/>	<input type="checkbox"/>
UBC_AI_xlweb2_188_2		8.91 V	Normal	AI	<input type="checkbox"/>	<input type="checkbox"/>	<input type="checkbox"/>	<input type="checkbox"/>
UBC_AO_Alarm_1		12.00 %	Normal	AO	<input type="checkbox"/>	<input type="checkbox"/>	<input checked="" type="checkbox"/>	<input type="checkbox"/>

30 sec Logout (SystemAdmin): 12/03/2012 15:24 Alarm Status (23 / 12)

Filter Options visible

Datapoints

Datapoint Filter

Datapoint List

Sort by: Entries per Page: 50

Name	Description	Value/Unit	Event State	Type	ALM	FLT	OVR	OOS
UBC_A1		8.93 V	Normal	AI	<input type="checkbox"/>	<input type="checkbox"/>	<input type="checkbox"/>	<input type="checkbox"/>
UBC_AI2		8.92 V	Normal	AI	<input type="checkbox"/>	<input type="checkbox"/>	<input type="checkbox"/>	<input type="checkbox"/>
UBC_AITemp		0.00 °C	Fault	AI	<input checked="" type="checkbox"/>	<input checked="" type="checkbox"/>	<input type="checkbox"/>	<input type="checkbox"/>
UBC_AI_xlweb2_188_1		8.92 V	Normal	AI	<input type="checkbox"/>	<input type="checkbox"/>	<input type="checkbox"/>	<input type="checkbox"/>
UBC_AI_xlweb2_188_2		8.91 V	Normal	AI	<input type="checkbox"/>	<input type="checkbox"/>	<input type="checkbox"/>	<input type="checkbox"/>
UBC_AO_Alarm_1		12.00 %	Normal	AO	<input type="checkbox"/>	<input type="checkbox"/>	<input checked="" type="checkbox"/>	<input type="checkbox"/>
UBC_AO_Alarm_2		0.00 %	Low Limit	AO	<input checked="" type="checkbox"/>	<input type="checkbox"/>	<input type="checkbox"/>	<input type="checkbox"/>
UBC_AO_SpaceTemp		23.00 °C	Normal	AO	<input type="checkbox"/>	<input type="checkbox"/>	<input type="checkbox"/>	<input type="checkbox"/>
UBC_AO_xlweb2_188_1		80.00 %	Normal	AO	<input type="checkbox"/>	<input type="checkbox"/>	<input type="checkbox"/>	<input type="checkbox"/>
UBC_AO_xlweb2_188_2		80.00 %	Normal	AO	<input type="checkbox"/>	<input type="checkbox"/>	<input type="checkbox"/>	<input type="checkbox"/>
UBC_AV_Alarm_1		0.00 K	Low Limit	AV	<input checked="" type="checkbox"/>	<input type="checkbox"/>	<input type="checkbox"/>	<input type="checkbox"/>
UBC_AV_Alarm_2		0.00 K	Low Limit	AV	<input checked="" type="checkbox"/>	<input type="checkbox"/>	<input type="checkbox"/>	<input type="checkbox"/>
UBC_AV_Cycle Ramp Off Time		300.00	Normal	AV	<input type="checkbox"/>	<input type="checkbox"/>	<input type="checkbox"/>	<input type="checkbox"/>

30 sec Logout (SystemAdmin): 12/03/2012 15:24 Alarm Status (23 / 12)

Filter Options hidden

Further Button Functions



(Browse) This button opens, for example, the Sort Order dialog where you can define the sort order for lists. Or, for example, it opens a calendar for picking a date.

GO / **NEW...** / **COPY** / and others

Those kind of specific buttons perform functions as the button name indicates in its functional context. For example, the NEW button on the *Fast Access Lists* tab creates a new fast access list.

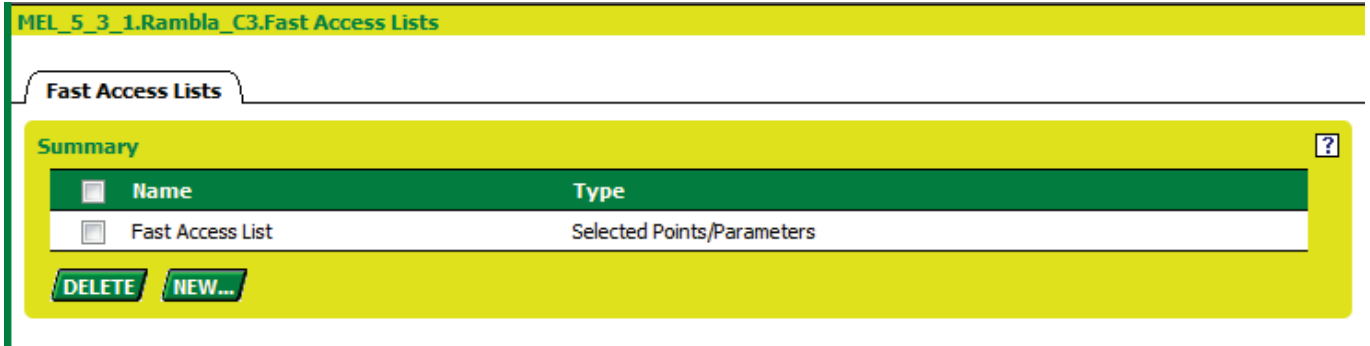

Multiselection of Items

Clicking the checkbox in the title line of a list,

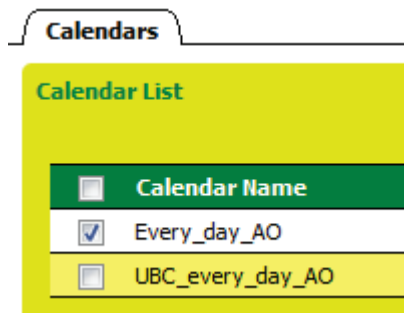

Simultaneously selects all entries in the list.

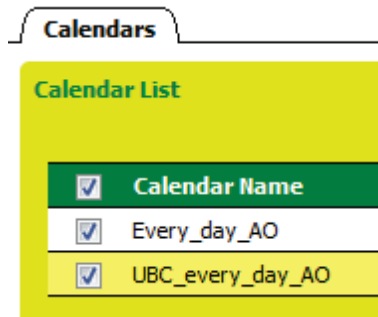

In particular dialogs, multiple items can be selected by using the SHIFT or the CTRL key simultaneously with the mouse clicking.

Configure List Display

Entries per page

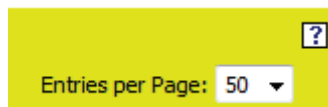

This option allows setting the number of entries to be displayed in a list. Small values enable you to quickly view a small number of entries. Large values enable you to get an overview of a long list but with decreased performance.

Page

Page: < | 1 | 2 | 3 | 4 | 5 | 6 | 7 ... 13 | >

By clicking on a specific page number you can display certain pages and/or by using the ≤ ≥ icons you can scroll through the list.

User Administration

Please refer also to the general "User Administration" section, p. 19.

Invoke User Administration

Procedure 1. In the tree, expand the *Advanced* item and click on **User Administration**.

RESULT: On the right, the *User* tab displays showing all existing users.

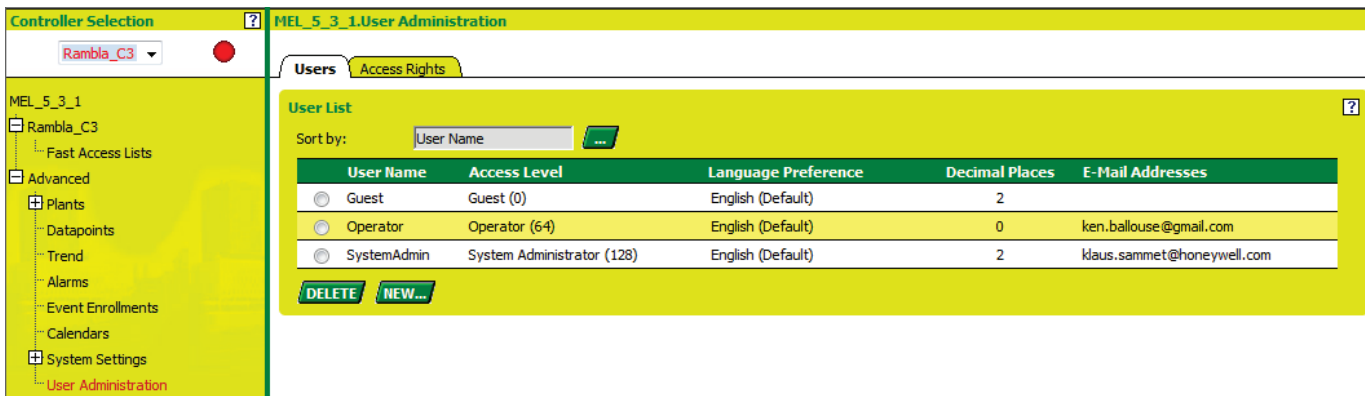

On the *User* tab, users can be newly created, edited and deleted. In addition, the user's password can be changed. By default the SystemAdmin and the Guest users are already available. For each user, the following properties are shown:

- User Name
- Access Level
- Language Preference
- Decimal Places
- E-Mail Addresses

On the *Access Rights* tab, the access rights for all users will be defined by assigning the predefined user levels to the executable functions (see Create Access Rights section).

Settings	
Description	User Level
Create & Delete Calendars	Operator (64) ▼
Create & Delete Schedules	Operator (64) ▼
Change Trend Settings	Operator (64) ▼
Display Diagnostics	Building Engineer (96) ▼
Display Communication Settings	Building Engineer (96) ▼
Change Communication Settings	Building Engineer (96) ▼
Start/Stop Plant Control Programs	Building Engineer (96) ▼
Display Cycle Speed Settings	Building Engineer (96) ▼
Change Cycle Speed Settings	Building Engineer (96) ▼
Change Clock Settings	Building Engineer (96) ▼
Create & Delete Fast Access Lists	Building Engineer (96) ▼
Create & Delete Users	System Administrator (128) ▼
Create & Delete E-Mail Addresses	Building Engineer (96) ▼

SUBMIT

Create Access Rights List

NOTE: Only the user who has System Admin or Project Admin user level can create or edit access rights. The System Admin level is automatically assigned to the user who has created the project initially in CARE.

- Procedure** 1. Select the *Access Rights* tab.

Settings	
Description	User Level
Create & Delete Calendars	Operator (64) ▼
Create & Delete Schedules	Operator (64) ▼
Change Trend Settings	Operator (64) ▼
Display Diagnostics	Building Engineer (96) ▼
Display Communication Settings	Building Engineer (96) ▼
Change Communication Settings	Building Engineer (96) ▼
Start/Stop Plant Control Programs	Building Engineer (96) ▼
Display Cycle Speed Settings	Building Engineer (96) ▼
Change Cycle Speed Settings	Building Engineer (96) ▼
Change Clock Settings	Building Engineer (96) ▼
Create & Delete Fast Access Lists	Building Engineer (96) ▼
Create & Delete Users	System Administrator (128) ▼
Create & Delete E-Mail Addresses	Building Engineer (96) ▼
	Guest (0) Tenant (32) Operator (64) Building Engineer (96) Project Administrator (115) System Administrator (128)

SUBMIT

2. To each function described in the *Description* column, assign the appropriate user level by selecting it in the corresponding line in the *User Level* column.

Note that the user levels are arranged hierarchically with the following sequence of descending priority:

- System Administrator (128) = highest priority

- Project Administrator (115)
- Building Engineer (96)
- Operator (64)
- Tenant (32)
- Guest (0) = lowest priority

3. Click SUBMIT button to save settings.

4. To create a new user, continue as described under the "Create User" section.

Create User

NOTE: Only the user who has System Admin user level can create users, edit, or delete existing users.

Procedure 1. Select the *User* tab.

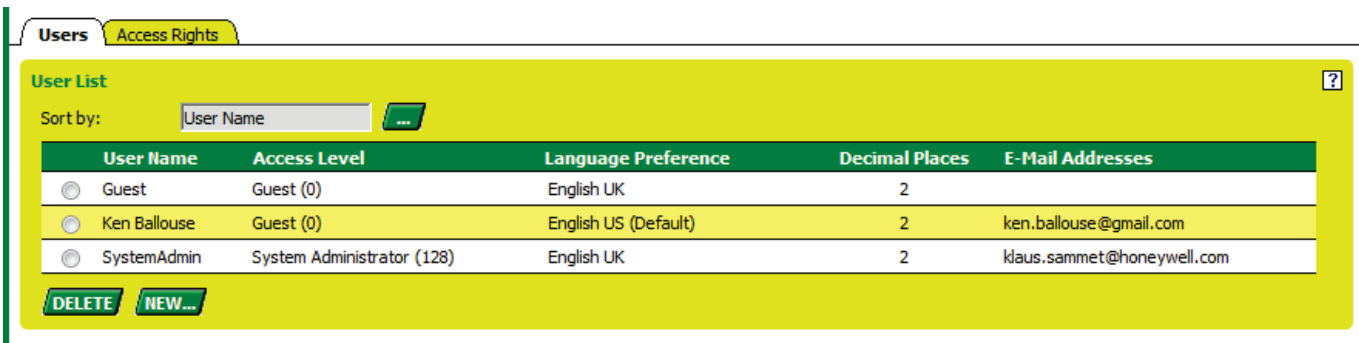

2. Click the NEW button.

RESULT: The *New / Edit User Profile* dialog box for creating a new user profile displays.

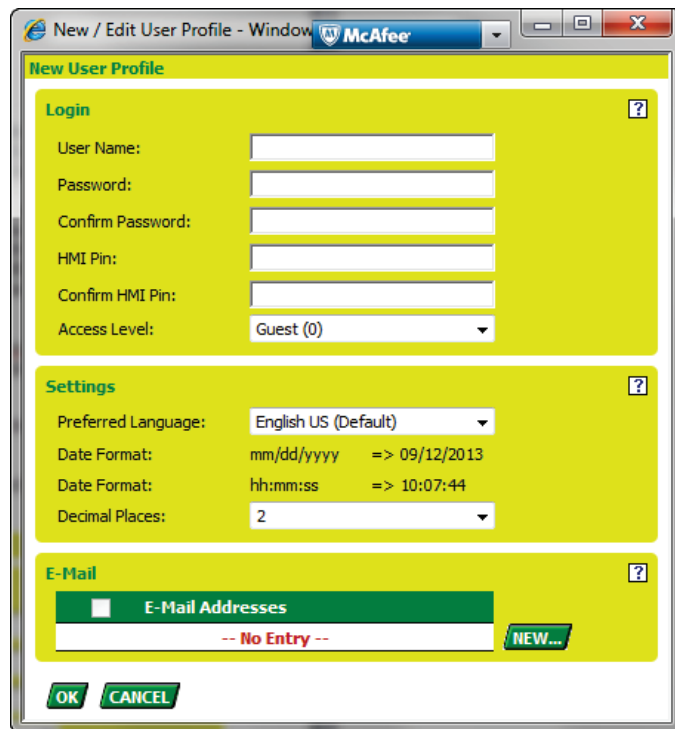

3. In the **User Name** field, enter the user name.

4. In the **Password** field, enter the password for the user.
5. In the **Confirm Password** field, confirm the new password by entering the password again.
6. In the **HMI Pin** field, enter a 4-digit pin number the user should enter in order to access the BACnet controller via Onboard HMI.
7. In the **Confirm HMI Pin** field, confirm the pin by entering the same number.
8. From the **Access Level** drop-down list box, select the user level.

Note that the user levels are arranged hierarchically with the following sequence of descending priority:

System Administrator (128)
Project Administrator (115)
Building Engineer (96)
Operator (64)
Tenant (32)
Guest (0)

Due to the access rights list definitions (see "Create Access Rights" section), this assignment automatically determines the set of access rights, which the user is allowed to execute in the Eagle Web Interface.

9. From the **Preferred Language** drop-down list box, select the language in which the Eagle Web Interface should be displayed for the user. If information is not available in the user's preferred language, the controller will send the information in the default language, defined in CARE. After logging in, the Eagle Web Interface is displayed in the user's preferred language.

Date Format

Displays the date format. It may be either dd.mm.yyyy or mm/dd/yyyy. The controller stores the date format along with the language setting.

Time Format

Displays the time format. The controller stores the time format along with the language setting.

10. From the **Decimal Places** drop-down list box, select the number of decimal places for the display of values.

New User Profile

Login [?]

User Name:

Password:

Confirm Password:

HMI Pin:

Confirm HMI Pin:

Access Level:

Settings [?]

Preferred Language:

Date Format: mm/dd/yyyy => 09/11/2013

Date Format: hh:mm:ss => 17:21:22

Decimal Places:

E-Mail [?]

E-Mail Addresses
-- No Entry --

- 10. To create an email address for the user for receiving email alarms created by the Eagle controller, click **New** button.

New E-Mail Address - Win McAfee

E-Mail Address [?]

Name:

- 11. In the New / Edit Address Entry dialog box, enter the email address, and then click OK.

NOTE: You can enter max. 5 email addresses per user.

RESULT: The email address is created and displayed in the *New / Edit User Profile* dialog box.

New User Profile

Login ?

User Name:

Password:

Confirm Password:

HMI Pin:

Confirm HMI Pin:

Access Level:

Settings ?

Preferred Language:

Date Format: mm/dd/yyyy => 09/11/2013

Date Format: hh:mm:ss => 17:23:27

Decimal Places:

E-Mail ?

E-Mail Addresses

<input type="checkbox"/>	tester@honeywell.com	DELETE
--------------------------	----------------------	---------------

NEW...

OK **CANCEL**

12. Click OK button to save settings.

RESULT: The created user is displayed on the *Existing Users* tab.

Users **Access Rights**

User List ?

Sort by: **...**

	User Name	Access Level	Language Preference	Decimal Places	E-Mail Addresses
<input type="radio"/>	Guest	Guest (0)	English UK	2	
<input type="radio"/>	Ken Ballouse	Guest (0)	English US (Default)	2	ken.ballouse@gmail.com
<input type="radio"/>	SystemAdmin	System Administrator (128)	English UK	2	klaus.sammet@honeywell.com
<input type="radio"/>	Tester	Guest (0)	English US (Default)	2	tester@honeywell.com

DELETE **NEW...**

Edit User

NOTE: Only the user who has System Admin user level can create new users and edit or delete existing users. The user name cannot be changed.

Procedure 1. On the *User* tab, click on the user in the *User Name* column.

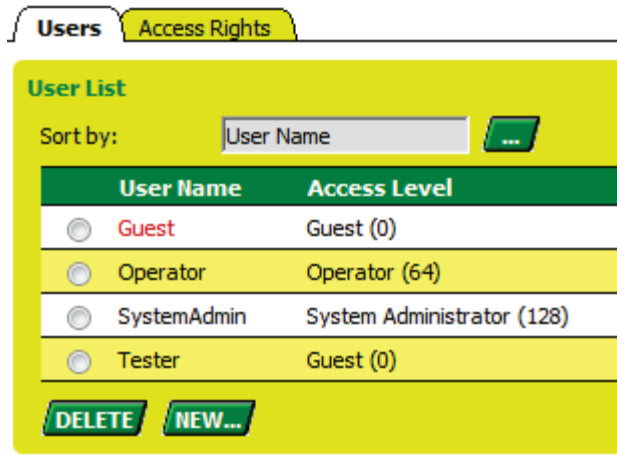

RESULT: The *New / Edit User Profile* dialog box displays.

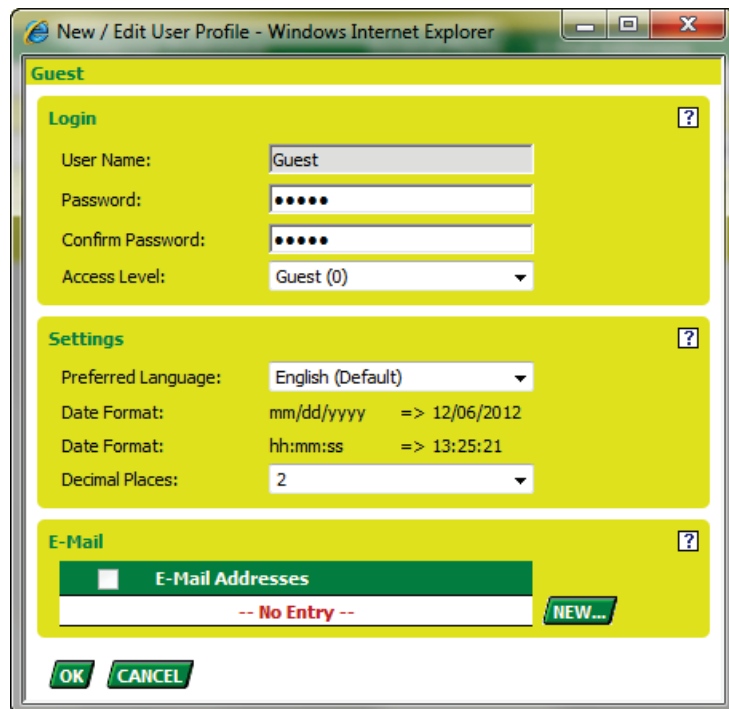

2. If desired, change the user level by selecting another level from the **Access Level** drop-down list box.

When changing the user level, note the sequence of descending priority of user levels:

- System Administrator (128)
- Project Administrator (115)
- Building Engineer (96)
- Operator (64)
- Tenant (32)
- Guest (0)

If the user level has been changed, you should note the current access rights definitions on the *Access Rights* tab in the *User administration* dialog box.

3. To change the password, click the **Password** button, and then change the password in the Change Password dialog box.
4. Click OK in the Change Password dialog box.
5. If desired, change the language in which the Eagle Web Interface should be displayed for the user by selecting another language from the **Preferred Language** drop-down list box. If information is not available in the user's preferred language, the controller will sent the information in the default language, defined by the CARE engineering tool. After logging in, the Eagle Web Interface is displayed in the user's preferred language.

Date Format

Displays the date format. It may be either dd.mm.yyyy or mm/dd/yyyy. The controller stores the date format along with the language setting.

Time Format

Displays the time format. The controller stores the time format along with the language setting.

6. If desired, change the number of decimal places for the display of values in the Eagle Web Interface by selecting another value from the **Decimal Places** drop-down list box.
7. If desired, create an email address for the user by clicking the **New** button (details, see "Create User" section). Or, delete the email address of the user by selecting the email address and then clicking the **Delete** button.
8. Click the OK button to save settings.

User Data Synchronization

CARE will synchronize user definitions made online in the Eagle Web Interface with the CARE database when the controller application is uploaded with CARE.

Delete User

NOTE: Only the user who has System Admin user level can create new users and edit or delete existing users.

Procedure

1. On the *User* tab, select the user you want to delete by clicking the corresponding radio button in the first column.

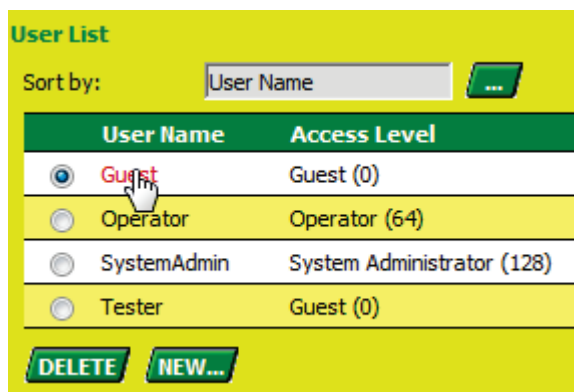

2. Click the DELETE button.

RESULT: The user is deleted from the list.

Display Project Information

Procedure

1. In the tree on the left, click on the project which is the top-level tree item.

RESULT: On the *Project* tab on the right, **Project Information** is displayed with the following properties:

The screenshot shows the Eagle Web Interface with the 'Project' tab selected. The left sidebar displays a tree view with 'MEL_5_3_1' selected. The main content area shows the 'Project Information' form with the following fields and values:

- Project Name: MEL_5_3_1
- Reference Number: 0
- Description: (empty text area)
- Customer: (empty text area)
- Order Number: 0
- Project Engineer: (empty text area)
- Units of Measurement: International Imperial
- Character Set: ANSI X3.4 / UTF-8 ISO 8859-1 Unicode UCS-2

- **Project Name**
Name of project, for example, site location
- **Reference Number**
A number that further describes the project. For example, branch number
- **Description**
Default Text about the project that may help to identify it.
- **Customer**
Customer name
- **Order Number**
Number assigned to project order
- **Project Administrator**
Name of responsible project engineer
- **Units of Measurement**
International or Imperial (English). This selection affects the operation of the icons in Control Strategy that perform EMS operations. The values for the inputs and outputs are different depending on the selection of International or English units.
- **Character Set**
The appropriate character set is necessary for unobstructed communication between devices on the BACnet bus. For proper communication between Eagle controllers and the BACnet client, the ANSI (or ISO Latin I) character set must have been selected in CARE.

Display Controller Information

Procedure 1. In the tree on the left, click on the controller.

RESULT: On the *General* tab on the right, general controller data are displayed:

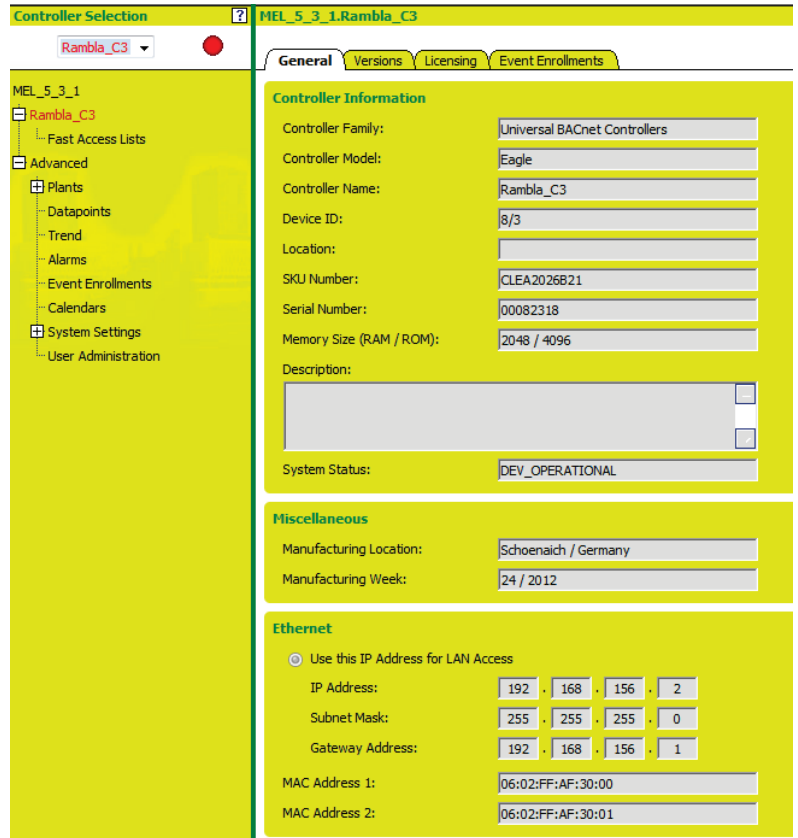

Controller Information

Shows controller specific properties such as:

- Controller Family
- Controller Model
- Controller Name
- Device ID
Object identifier of the BACnet device object. This is a unique ID is issued by CARE for any device on the BACnet bus. If the BACnet device is an Eagle controller, the device ID is the same as the controller number.
- NOTE:
When integrating 3rd party BACnet devices, it must be ensured that no identical device IDs exist in the whole BACnet system. For that reason, an offset can be defined. Adding this offset to the controller number generates the device ID.
- Location
Additional Text for the controller, which indicates the location of the controller, e.g. Floor 4, Section Nord.
- SKU Number
OS number
- Serial Number
- Memory Size (RAM / ROM)
- Description
Additional descriptive text
- System Status
DEV_OPERATIONAL, which means the controller is operating

Miscellaneous

- Manufacturing location
Factory where the controller has been produced
- Manufacturing week
Week when the controller has been produced

Ethernet

Shows network specific properties of the IP address allocation mode:

- Use this IP address for LAN Access
IP address, subnet mask and gateway address have been allocated explicitly in CARE.
- MAC address 1
shows MAC address 1
- MAC address 2
shows MAC address 2

LON Bus

Shows LON specific properties of the controller such as:

- Neuron Chip ID
Displays neuron ID of the controller.
- Subnet-Node Address Domain 0
Displays subnet/node address of domain 0 as defined in CARE
- Subnet-Node Address Domain 1
Defaults to zero.

2. To view Version information of the controller, click the *Versions* tab.

Controller Selection MEL_5_3_1.Rambla_C3

Rambla_C3

General Versions Licensing Event Enrollments

Controller Related Data

Controller Name: Rambla_C3

SKU Number: CLEA2026B21

Firmware Version: UBC_3-00-00-10 Last Download: 11/29/2012, 18:39:59

Object Synchronisation Version: 1.0.0

Linux Image Version: UBC-Linux_1-00-00-09 Last Download: 12/03/2012, 11:39:33

BACnet Stack Version: UBC_3-00-00-10 Last Download: 11/29/2012, 18:40:00

PHP Version: UBC_3-00-00-10 Last Download: 11/29/2012, 18:24:19

Web Server Version: UBC_3-00-00-10 Last Download: 11/29/2012, 18:24:18

Web Pages Version: UBC_3-00-00-10 Last Download: 11/29/2012, 18:23:09

Application Related Data

Appl. Software Version: 2

Last Download: 12/03/2012, 11:36:24

Tool Name: CARE

Tool Version: 10.00.00.241

Application Files:

Name	Type	Sequence	Last Saved
	1024	2	12/03/2012 11:39:17
	1031	1	12/03/2012 09:37:01
	1030	1	12/03/2012 09:37:01
	1043	1	12/03/2012 09:37:01
	256	1	12/03/2012 09:37:01
	1036	1	12/03/2012 09:37:01
	1038	1	12/03/2012 09:37:01
	1025	2	12/03/2012 11:39:17
	1029	2	12/03/2012 11:39:17

Version data includes:

Controller Related Data such as:

- Controller Name
- SKU Number
- Firmware Version
- Object Synchronization Version
- Linux Image Version
- BACnet Stack Version
- PHP Version
- Web Server Version
- Web Pages Version

For all data except object synchronization version, the date of the last download is shown right to the item.

Application Related Data such as:

- Appl. Software Version
Number of the translated application. With each translation and download of the application, the number will be increased.
- Last Download (date and time)
- Tool Name (used for application creation)

- Tool Version
- Application Files
 - The application is stored in different files for plants, loops, controllers etc. Each file has a name, type (data type), version (controller), sequence (version of application file) and date.
 - Version indicates the firmware version.
 - Type indicates which Object Types are contained in the application file.
 - Sequence indicates online changes, e.g. of Quick Access Groups, Parameters, User Administration etc.
 - With every online change, the sequence number is incremented.
 - Last Saved indicates the time when this application file was created in the CARE tool (time of last CARE translation) or when the file has been saved due to an online change.

3. To view licensing information of the controller, click the *Licensing* tab.

The screenshot shows the 'Licensing' tab selected. The main content area is titled 'License Related Data' and contains the following information:

- Controller Family: Universal BACnet Controllers (UBC)
- Controller Model: Eagle
- SKU Number: CLEA2026B21
- Serial Number: 00082318
- License File Creation Date: 08/21/2012, 09:37:00
- Status: OK

Below this information is a table of Licensed Features:

Feature Name	Value
bacnet_ip	1
bacnet_ip_max_fd	*
bacnetmstp	1
bacnetmstp_max_fd	*
free_prog_applications	1
lonbus	1
lonbus_max_fd	*
panelbus	1
webservice	1

* No limit due to licensing

Licensing data includes:

License Related Data such as:

- Controller Family
- Controller Model
- SKU Number
- Serial Number
- License File Creation Date
- Status
 - OK = license files status is OK
 - WRONG_CONTROLLER_ID = the license file does not fit to the controller hardware
 - SIG_INVALID = a signature within the license file is not valid
 - CANNOT_READ = cannot read xml content of license file correctly
 - CANNOT_OPEN = license file not available or corrupt

In any case the license is invalid or damaged, the DDC engine of the controller does not run. The tools connection to the controller already works to notify about the situation, In addition, the red alarm LED of controller will be ON in case of a failure

- Licensed Features
 - 1 = feature enabled
 - * = no limit due to licensing

4. To view event enrollments information of the controller, click the *Event Enrollments* tab. Note that the event enrollment must be enabled in CARE on the System Status tab of the controller.

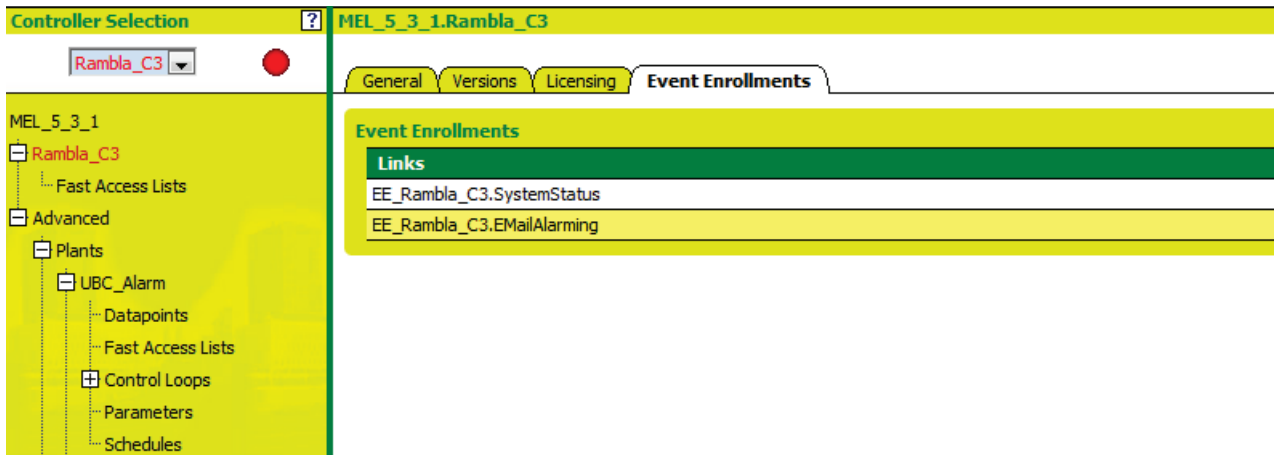

5. To view event enrollments information of the controller, click the *Event Enrollments* tab. For details, please refer the "Enable Event *Enrollment* Alarming for Controller System Status" section and the "Enable Event *Enrollment* Alarming for Controller Email Alarming" section.

Device Name

For 3rd party BACnet devices, a freely editable device name can be defined. If the BACnet device is an Eagle controller, the device name is the same as the controller name.

IMPORTANT

Do not use blanks or special characters.

Display Plant Information

Please refer also to the "Plants" section, p. 99.

Procedure

1. In the tree on the left, expand the *Advanced* item, then the *Plants* item and click on the single plant.

RESULT: On the *Plant* tab on the right, general plant data are displayed.

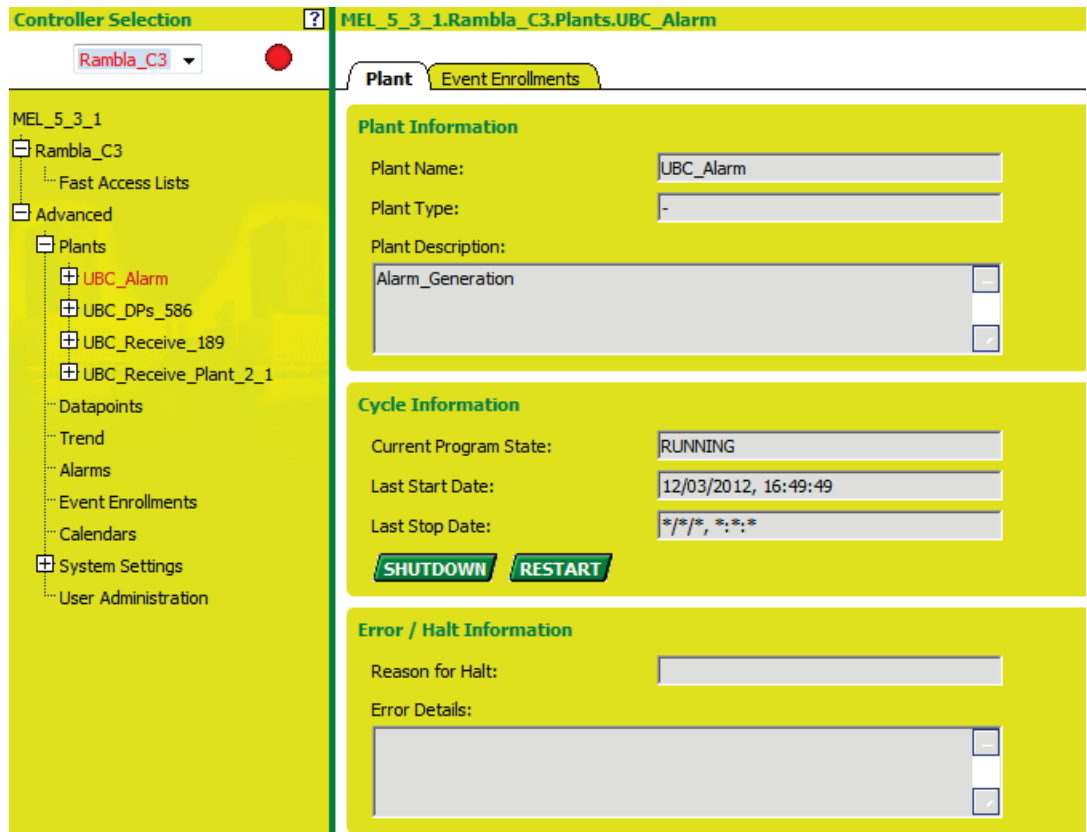

Plant Information

Shows general plant properties such as:

- Plant Name
- Plant Type
- Plant Description

Cycle Information

Shows application specific properties related to the plant such as:

- Current Program State (running or stopped)
- Last Start Date
- Last Stop Date

The application program controlling the plant can be stopped individually by clicking the SHUTDOWN button and restarted by clicking the RESTART button.

IMPORTANT

Stopping and restarting the program does not stop and restart the entire controller application, but parts of the application which control that particular plant.

Error / Halt Information

Shows errors and halt information such as:

- Reason for Halt
- Error Details

NOTE: You can only shutdown or restart the control program if your access level is equal to or higher than the access level defined for these actions in the User Administration.

Fast Access Lists

Fast access lists are user specific lists which show suited information to dedicated people (e.g. electrician, project engineer, tenant).

Information can be either a list of certain datapoints, e.g. all outputs by using a filter template, or a list showing the impact of selected parameter values on datapoints.

Fast access lists can be created on controller level and on plant level. In plant related fast access lists, you can only view datapoints/parameters of this particular plant whereas controller related fast access lists can comprise datapoints/parameter of different plants of the controller.

Selected Points List

Name	Value/Unit	Event State	Type	ALM	FLT	OOS	Description	OVR
UBC_A1	8.00 V	Normal	AI	<input type="checkbox"/>	<input type="checkbox"/>	<input checked="" type="checkbox"/>		<input type="checkbox"/>
UBC_AI2	9.00 V	Normal	AI	<input type="checkbox"/>	<input type="checkbox"/>	<input checked="" type="checkbox"/>		<input type="checkbox"/>
UBC_AITemp	0.00 °C	Fault	AI	<input checked="" type="checkbox"/>	<input checked="" type="checkbox"/>	<input type="checkbox"/>		<input type="checkbox"/>
UBC_AO_Alarm_1	12.00 %	Normal	AO	<input type="checkbox"/>	<input type="checkbox"/>	<input type="checkbox"/>		<input checked="" type="checkbox"/>
UBC_AO_Alarm_2	0.00 %	Low Limit	AO	<input checked="" type="checkbox"/>	<input type="checkbox"/>	<input type="checkbox"/>		<input type="checkbox"/>
UBC_Alarm_Cycle_On_Off_time	30.00	Normal	AV	<input type="checkbox"/>	<input type="checkbox"/>	<input type="checkbox"/>		<input type="checkbox"/>
UBC_AV_Alarm_1	0.00 K	Low Limit	AV	<input checked="" type="checkbox"/>	<input type="checkbox"/>	<input type="checkbox"/>		<input type="checkbox"/>
UBC_AV_Alarm_2	0.00 K	Low Limit	AV	<input checked="" type="checkbox"/>	<input type="checkbox"/>	<input type="checkbox"/>		<input type="checkbox"/>

Selected Parameters List

Name	Value/Unit	Symbol Type	Parameter Path
on time	30.00	Cycle	.UBC_Alarming.Alarm_Takt
off time	30.00	Cycle	.UBC_Alarming.Alarm_Takt

< BACK MODIFY...

Create Fast Access List

NOTE: The user can only create and delete a fast access list if his/her access level is equal to or higher than the access level defined for these actions. Otherwise the CREATE and DELETE buttons are not displayed.

A fast access list is only displayed for the user if the user's read access level is equal to or higher than the read access level of the fast access list.

Procedure

1. In the tree on the left, expand the tree and navigate to the item (either controller or plant) you want to create the fast access list for.
2. Click on **Fast Access Lists**.

If available all existing user-defined fast access lists are displayed on the *Fast Access Lists* tab. A fast access list can be created either as datapoint/parameter overview or as filter template.

Fast Access Lists

Summary

Name	Type
Fast Access List	Selected Points/Parameters

DELETE NEW...

3. In the *Name* column, the fast access lists are listed by name.

4. In the *Type* column, the type (datapoint/parameter overview or filter template) is shown.
5. To create a new fast access list, click the NEW button.

RESULT: The *New / Edit Fast Access List* dialog box displays.

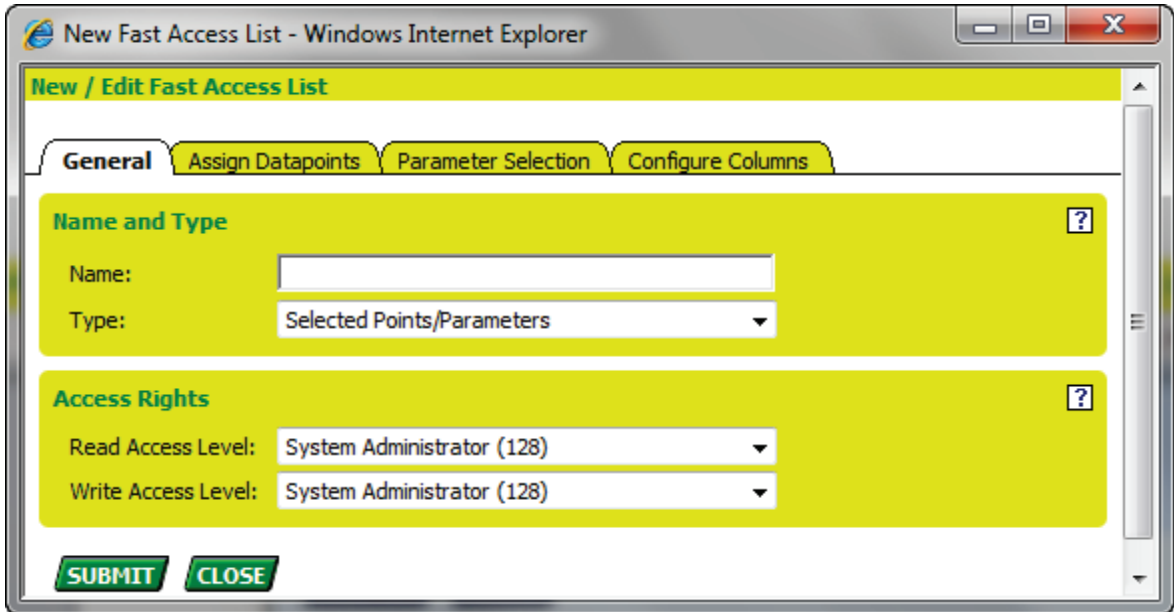

6. On the *General* tab, enter a name in the **Name** field.

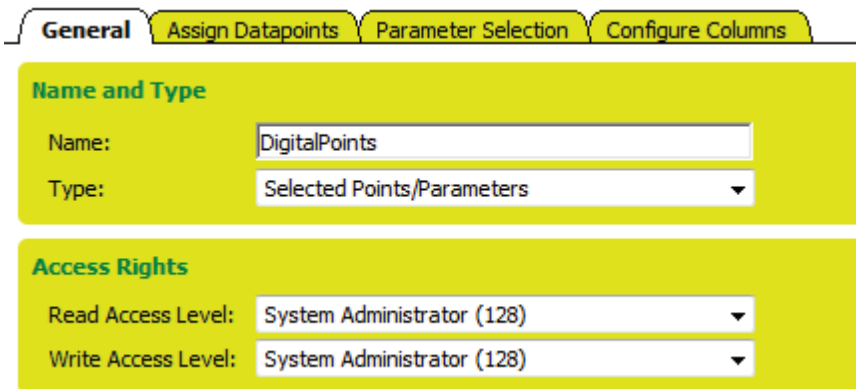

7. From the **Type** drop-down list box, select the fast access list type under:

Selected Points/Parameters

Allows watching the impact of changed parameter values on datapoints. The parameter values are changed online.

Filter Template

Allows quickly displaying certain datapoints of a plant.

NOTE: If this option is selected, the *Assign Parameters* tab will not be available.

8. From the **Read Access Level** and **Write Access Level** drop-down list boxes, select the user levels that should have read and write access of the fast access list.
9. If you have selected the fast access list type 'Selected Points/Parameters', continue with step 10. If you have selected the fast access list type 'Filter Template', continue with step 34.

10. Click on the *Assign Datapoints* tab.

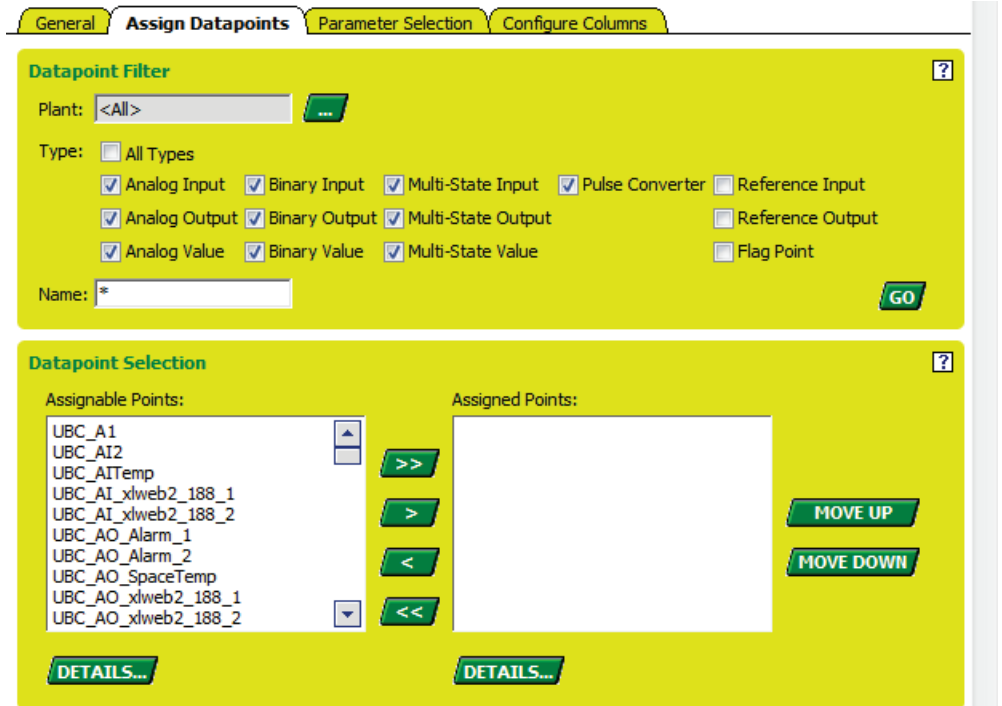

11. Under **Datapoint Filter**, select the point types that should be used in the fast access list, as follows:

- a. Under **Plant**, select plant(s) of which datapoints you want to be displayed by clicking the BROWSE button and selecting the plants in the *Select Plants* dialog box.

RESULT: Only the datapoints belonging to these plant(s) will be shown.

- b. Under **Type**, check/uncheck specific datapoint types to be included/excluded from the filter.

- c. Under **Name**, specific datapoint names can be filtered by entering a search text. By default all datapoints will be displayed as indicated by an asterisk. To display specific datapoint (names), enter the appropriate search text.

12. Click the GO Button to apply the filter.

RESULT: In the *Assignable Points* list, all datapoints matching the filter criteria will be displayed.

In the *Assigned Points* list, already-assigned datapoints are displayed.

13. To move points between lists, that is, to make them assigned or assignable, do one of the following:

- a. In the *Assigned Points* list or in the *Assignable Points* list, highlight the points to be moved. Multiselection by using the CTRL or the SHIFT key is possible.
- b. Click the SINGLE ARROW button with desired direction.

Or,

- c. To move all points in one step,

d. Click the DOUBLE ARROW button with desired direction.

NOTE: Only those datapoints are displayed of which read access level is equal to or lower than the read access level of the user.

- To change the row sort order in the fast access list, use the MOVE UP and MOVE DOWN buttons. Multiselection by using the CTRL or the SHIFT key is possible.

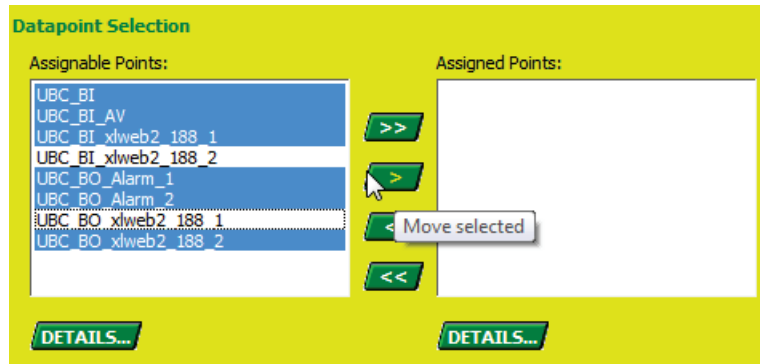

- Click on the Assign Parameters tab.

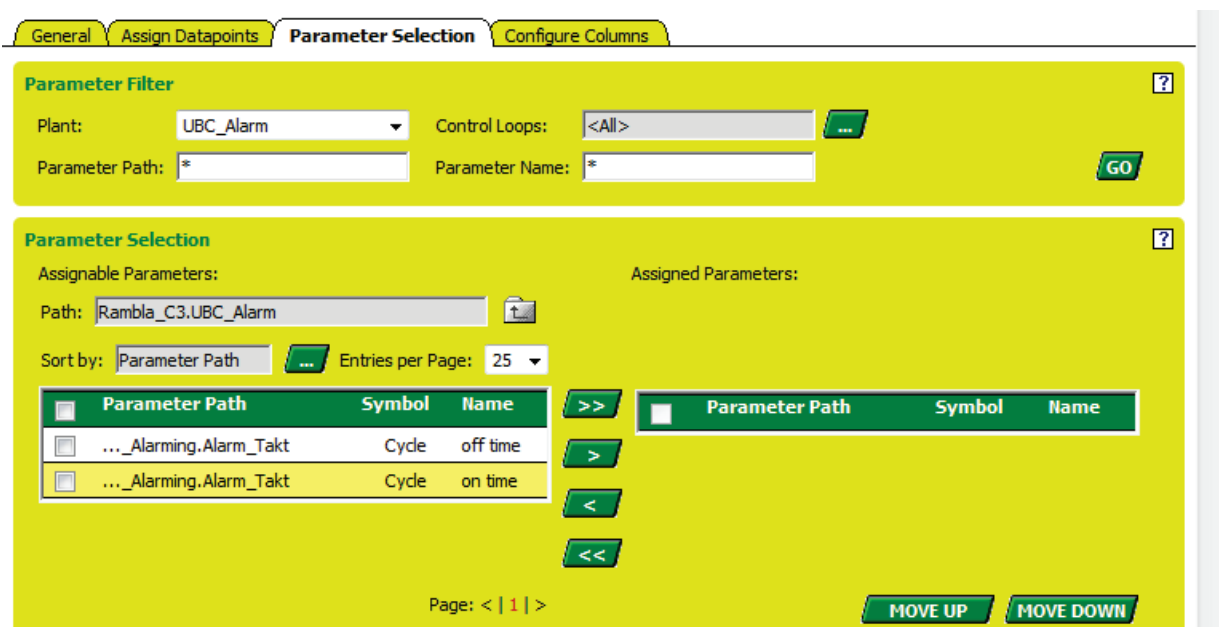

Here can you configure the parameter filter for assigning parameters to the fast access list. Filtering is possible for control loops on plant level. Filter criteria are parameter path and parameter name. All parameters matching the filter criteria will be displayed in the *Assignable Parameters* list.

- From the **Plant** drop-down list box, select the plant.
- Under **Control Loops**, select control loop(s) by clicking the BROWSE button.
- In the **Parameter Path** field, parameters can be filtered by their path. In the **Parameter Name** field, parameters can be filtered by their names.
- Enter search criteria in the **Parameter Path** field and/or the **Parameter Name** field.

The search is case-sensitive and wildcards (*) and jokers (?) can be used. The asterisk * can only be used at the beginning or the end of the search entry. By default, the filter shows *, displaying parameters of all icons below the current

level. If any text is entered without wildcards, software searches for the exact match.

20. Click the GO Button to start search according to the filter criteria. All parameters matching the filter criteria will be displayed in the datapoints list in the lower *Assignable Parameters* area.

RESULT: In the *Assigned Parameters* list, already-assigned parameters are displayed.

In each list, the parameter path, name, and symbol are shown.

The path of the *Assignable Parameters* is displayed in the **Path** field. The *Assignable Parameters* list shows the parameter path, the name and the symbol of each parameter.

21. To navigate upwards in the path, click on *Up on Level* icon . To navigate downwards, click the on the parameter path entry in the list. Note the path display in the **Path** field.

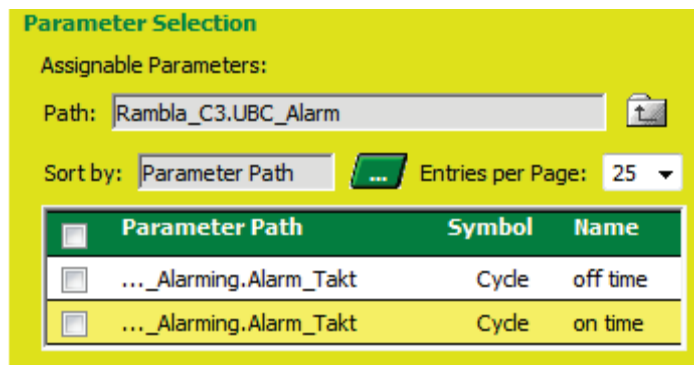

22. To sort the *Assignable Parameters* list differently, click the BROWSE button at the **Sort by** field.
23. To change the row sort order for the fast access list, use the MOVE UP and MOVE DOWN buttons in the *Assigned Parameters* list.
24. To move parameters between lists, that is, to make them assigned or assignable, do one of the following:
 - a. In the *Assigned Parameters* list or in the *Assignable Parameters* list, highlight the parameters to be moved. Multiselection by using the CTRL or the SHIFT key is possible.
 - b. Click the SINGLE ARROW button with desired direction.

Or,

 - c. To move all parameters in one step, Click the DOUBLE ARROW button with desired direction.

Parameter Selection

Assignable Parameters: Path:

Sort by: Entries per Page:

<input type="checkbox"/>	Parameter Path	Symbol	Name
<input type="checkbox"/>	..._Alarming.Alarm_Takt	Cycle	off time
<input type="checkbox"/>	..._Alarming.Alarm_Takt	Cycle	on time

Assigned Parameters:

<input type="checkbox"/>	Parameter Path	Symbol	Name
<input type="checkbox"/>	..._Alarming.Alarm_Takt	Cycle	off time
<input type="checkbox"/>	..._Alarming.Alarm_Takt	Cycle	on time

25. Click the *Configure Columns* tab.

General Assign Datapoints Parameter Selection **Configure Columns**

Datapoint columns to display

Available Columns:

Visible Columns:

* The marked columns can be neither removed nor be moved up/down.

Parameter columns to display

Available Columns:

Visible Columns:

* The marked columns can be neither removed nor be moved up/down.

Here you can configure the columns display for the datapoints and parameters in the fast access list by selecting the column titles and the column order. The *Available Columns* list shows the max. number of available columns. The *Visible Columns* list shows the columns that will be displayed in the fast access list.

Column display will be configured by moving the columns between the *Available Columns* list and *Visible Columns* list.

26. To move column(s) between lists, that is, to make them visible or not, do one of the following:
 - a. To move single column(s),
In the *Available Columns* list or in the *Visible Columns* list, highlight the columns to be moved. Multiselection by using the CTRL or the SHIFT key is possible.
 - b. Click the SINGLE ARROW button with desired direction.

Or,

- c. To move all column(s) in one step,
Click the DOUBLE ARROW button with desired direction.

NOTE: Columns marked with asterisk * cannot be removed from the *Visible Columns* list.

- d. To set the display order in the *Visible Columns* list, highlight the column and use the MOVE UP and MOVE DOWN buttons.

- 27. Click the SUBMIT button to save settings done on the *General, Assign Datapoints, Assign Parameters* and *Configure Columns* tabs and click the CLOSE button.

RESULT: The list is inserted under *Summary* on the *Fast Access List* tab.

MEL_5_3_1.Rambla_C3.Fast Access Lists

Fast Access Lists

Summary

<input type="checkbox"/>	Name	Type
<input type="checkbox"/>	DigitalPoints	Selected Points/Parameters
<input type="checkbox"/>	Fast Access List	Selected Points/Parameters

DELETE **NEW...**

- 28. To change a parameter, click on the fast access list in the *Name* column under **Summary**.

RESULT: The fast access list displays.

MEL_5_3_1.Rambla_C3.Fast Access Lists.DigitalPoints

DigitalPoints

Selected Points List

Name	Description	Value/Unit	Event State	Type	ALM	FLT	OVR	OOS
UBC_BI		ALARM	Off Normal	BI	<input checked="" type="checkbox"/>	<input type="checkbox"/>	<input type="checkbox"/>	<input checked="" type="checkbox"/>
UBC_BI_AV		ALARM	Off Normal	BI	<input checked="" type="checkbox"/>	<input type="checkbox"/>	<input type="checkbox"/>	<input type="checkbox"/>
UBC_BI_xlweb2_188_1		ON	Normal	BI	<input type="checkbox"/>	<input type="checkbox"/>	<input type="checkbox"/>	<input checked="" type="checkbox"/>
UBC_BO_Alarm_1		ALARM	Normal	BO	<input type="checkbox"/>	<input type="checkbox"/>	<input type="checkbox"/>	<input type="checkbox"/>
UBC_BO_Alarm_2		ALARM	Normal	BO	<input type="checkbox"/>	<input type="checkbox"/>	<input type="checkbox"/>	<input type="checkbox"/>
UBC_BO_xlweb2_188_2		ON	Normal	BO	<input type="checkbox"/>	<input type="checkbox"/>	<input type="checkbox"/>	<input type="checkbox"/>

Selected Parameters List

Parameter Path	Symbol Type	Name	Value/Unit
.UBC_Alarming.Alarm_Takt	Cycle	off time	30.00
.UBC_Alarming.Alarm_Takt	Cycle	on time	30.00

< BACK **MODIFY...**

- 29. Click on the parameter in the *Name* column under **Selected Parameters List**.

Selected Parameters List			
Parameter Path	Symbol Type	Name	Value/Unit
.UBC_Alarming.Alarm_Takt	Cycle	off time	30.00
.UBC_Alarming.Alarm_Takt	Cycle	on time	30.00

[< BACK](#) [MODIFY...](#)

RESULT: The *Parameter Value* dialog box displays.

- Click the DETAILS << button if you want to display additional information such as plant name, control loop name, parameter path and symbol type.

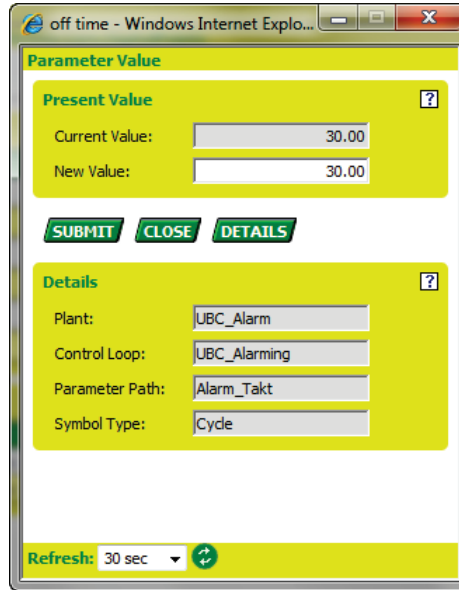

- In the **New Value** field, enter the changed parameter value and click the SUBMIT button.

RESULT: Under **Selected Parameters List**, the value is updated in the *Value/Unit* column.

Name	Value/Unit
off time	20.00
on time	30.00

- Watch the impact on values under **Selected Points List** above.
- To finish, click the BACK button.

RESULT: The *Fast Access Lists* tab is redisplayed.

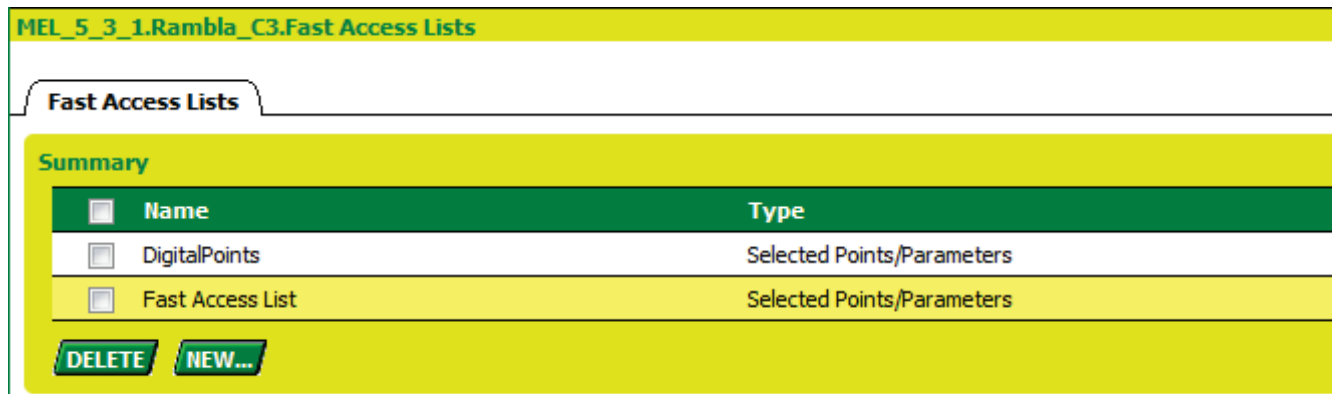

34. ...continued from step 7 when having selected fast access list type 'Filter Template'. Click on the *Assign Datapoints* tab.

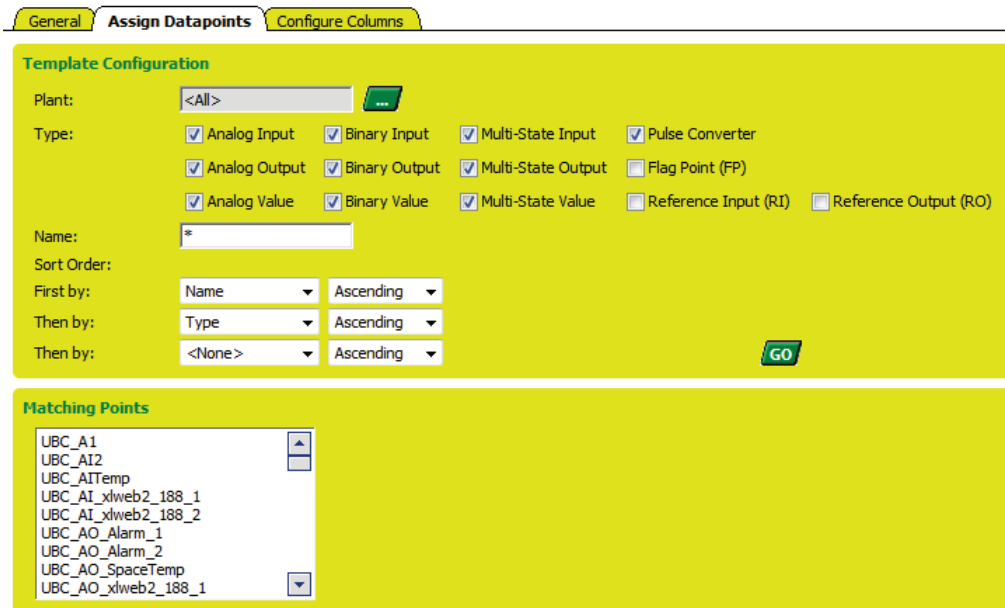

35. Under **Template Configuration**, configure the filter template by selecting the plant and point types that should be displayed (filter criteria) in the fast access list as follows:

Under **Plant**, select plant(s) of which datapoints you want to be displayed by clicking the BROWSE button. Only the datapoints belonging to these plant(s) will be shown.

Under **Type**, check/uncheck specific datapoint types to be included/excluded from the filter.

Under **Name**, specific datapoint names can be filtered by entering a search text. By default all datapoints will be displayed as indicated by an asterisk. To display specific datapoint (names), enter the appropriate search text.

Under **Sort Order**, define the sort order for the list by selecting the column titles and the sorting mode. For the basic naming of the column titles, see the *Configure Column* tab description in the following steps.

36. Click the GO Button to apply the filter. All datapoints matching the filter criteria will be displayed under **Matching Points**.

NOTE: Only those datapoints are displayed of which read access level is equal to or lower than the read access level of the user.

General Assign Datapoints **Configure Columns**

Template Configuration

Plant: <All> [...]

Type: Analog Input Binary Input Multi-State Input Pulse Converter
 Analog Output Binary Output Multi-State Output Flag Point (FP)
 Analog Value Binary Value Multi-State Value Reference Input (RI) Reference Output (RO)

Name: *

Sort Order:

First by: Name [v] Ascending [v]
 Then by: Type [v] Ascending [v]
 Then by: <None> [v] Ascending [v] [GO]

Matching Points

UBC_BI
 UBC_BI_AV
 UBC_BI_xlweb2_188_1
 UBC_BI_xlweb2_188_2
 UBC_BO_Alarm_1
 UBC_BO_Alarm_2
 UBC_BO_xlweb2_188_1
 UBC_BO_xlweb2_188_2
 UBC_BV_Alarm_1

37. Click on the *Configure Columns* tab.

General Assign Datapoints **Configure Columns**

Datapoint columns to display

Available Columns: Object ID

Visible Columns: Point Name*
 Description
 Value/Unit
 Event State
 Point Type
 Status Flag "In Alarm"
 Status Flag "Fault"
 Status Flag "Overridden"
 Status Flag "Out Of Service"

[>>] [>] [<] [<<] [MOVE UP] [MOVE DOWN]

* The marked columns can be neither removed nor be moved up/down.

[SUBMIT] [CLOSE]

Here you can configure the columns display for the datapoints list of the fast access list by selecting the column titles and the column order.

The *Available Columns* list shows the max. number of available columns. The *Visible Columns* list shows the columns of which the datapoints list consists. Column display will be configured by moving the columns between the *Available Columns* list and *Visible Columns* list.

38. To move column(s) between lists, that is, to make them visible or not, do one of the following:
- To move single column(s),
 - In the *Available Columns* list or in the *Visible Columns* list, highlight the columns to be moved. Multiselection by using the CTRL or the SHIFT key is possible.
 - Click the SINGLE ARROW button with desired direction.
Or,
 - To move all column(s) in one step,
Click the DOUBLE ARROW button with desired direction.

NOTE: Columns marked with an asterisk * cannot be removed from the *Visible Columns* list.

- e. To set the display order in the *Visible Columns* list, highlight the column and use the MOVE UP and MOVE DOWN buttons.
- 39. Click the SUBMIT button to save settings done on the *General*, *Assign Datapoints* and *Configure Columns* tabs.
- 40. Click the BACK button.

RESULT: The fast access list is displayed on the *Fast Access Lists* tab. To modify a fast access list, please refer to the "View/Modify Fast Access List" section.

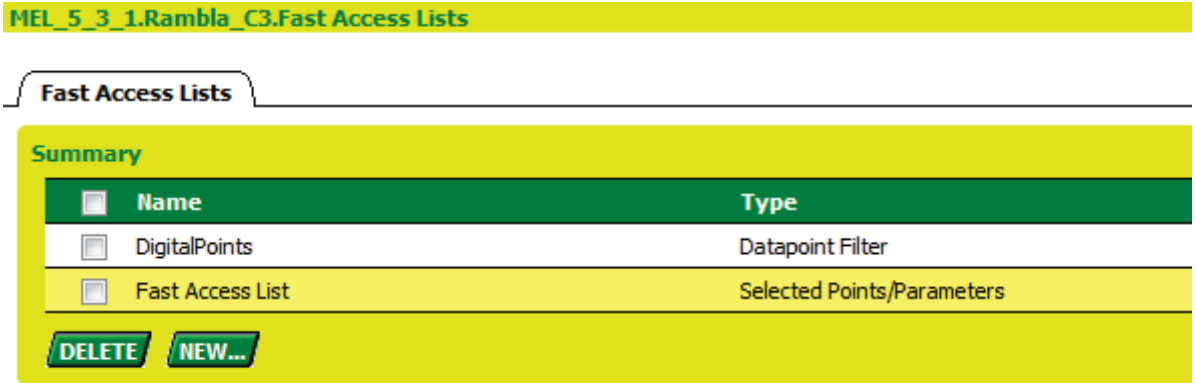

View / Modify Fast Access List

- Procedure**
1. To display a fast access list, click on the name under **Summary**.

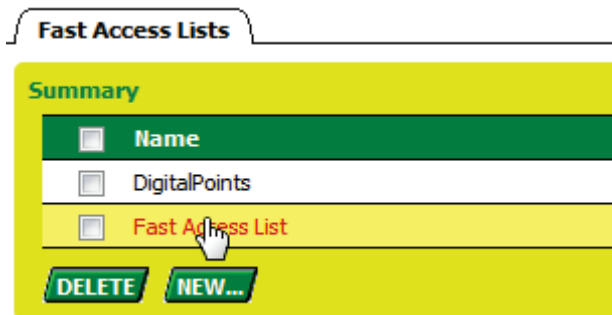

RESULT: The datapoint list will be displayed. In this case, all value points are displayed.

Fast Access List

Selected Points List

Name	Value/Unit	Event State	Type	ALM	FLT	OOS	Description	OVR
UBC_A1	8.00 V	Normal	AI	<input type="checkbox"/>	<input type="checkbox"/>	<input checked="" type="checkbox"/>		<input type="checkbox"/>
UBC_AI2	9.00 V	Normal	AI	<input type="checkbox"/>	<input type="checkbox"/>	<input checked="" type="checkbox"/>		<input type="checkbox"/>
UBC_AITemp	0.00 °C	Fault	AI	<input checked="" type="checkbox"/>	<input checked="" type="checkbox"/>	<input type="checkbox"/>		<input type="checkbox"/>
UBC_AO_Alarm_1	12.00 %	Normal	AO	<input type="checkbox"/>	<input type="checkbox"/>	<input type="checkbox"/>		<input checked="" type="checkbox"/>
UBC_AO_Alarm_2	0.00 %	Low Limit	AO	<input checked="" type="checkbox"/>	<input type="checkbox"/>	<input type="checkbox"/>		<input type="checkbox"/>
UBC_Alarm_Cycle_On_Off_time	30.00	Normal	AV	<input type="checkbox"/>	<input type="checkbox"/>	<input type="checkbox"/>		<input type="checkbox"/>
UBC_AV_Alarm_1	0.00 K	Low Limit	AV	<input checked="" type="checkbox"/>	<input type="checkbox"/>	<input type="checkbox"/>		<input type="checkbox"/>
UBC_AV_Alarm_2	0.00 K	Low Limit	AV	<input checked="" type="checkbox"/>	<input type="checkbox"/>	<input type="checkbox"/>		<input type="checkbox"/>

Selected Parameters List

Name	Value/Unit	Symbol Type	Parameter Path
on time	30.00	Cycle	.UBC_Alarming.Alarm_Takt
off time	30.00	Cycle	.UBC_Alarming.Alarm_Takt

< BACK MODIFY...

2. Click the MODIFY button.

RESULT: The *New / Edit Fast Access List* dialog box displays.

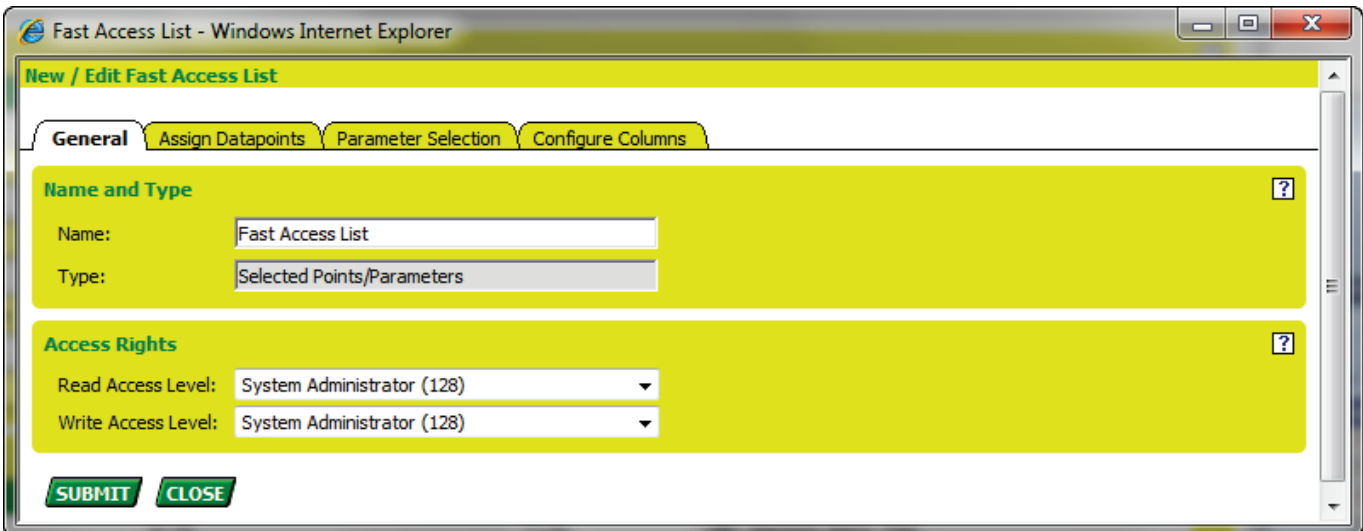

3. Assuming that you want to display only the analog value points, edit the name to analog value points in the **Name** field.

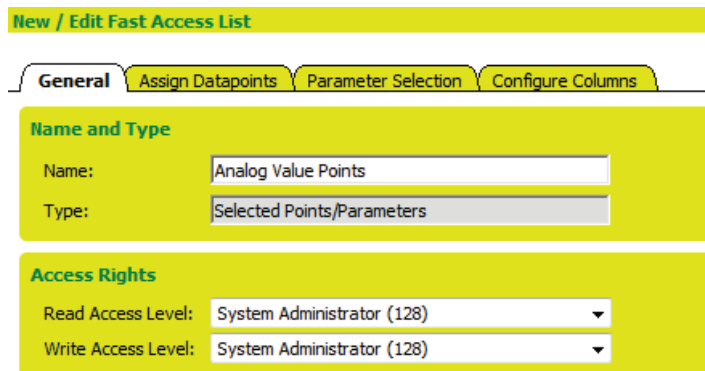

4. Click the *Assign Datapoints* tab.

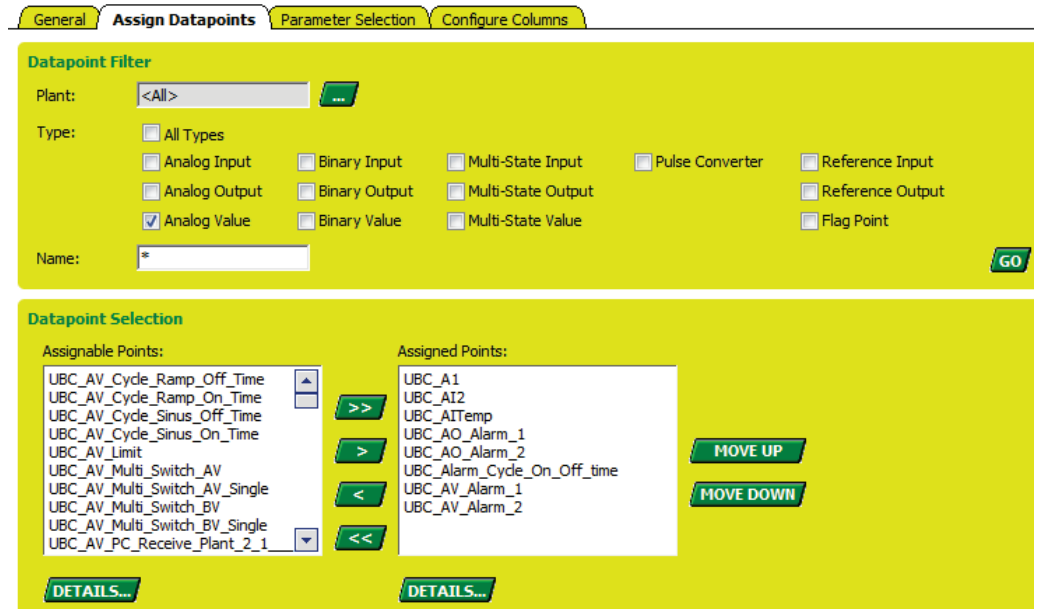

5. Remove all points from the Assigned Points list.
6. Under **Datapoint Filter**, uncheck All Types, check Analog Value, and then click the GO button.

RESULT: Under **Assignable Points**, all analog value points are listed.

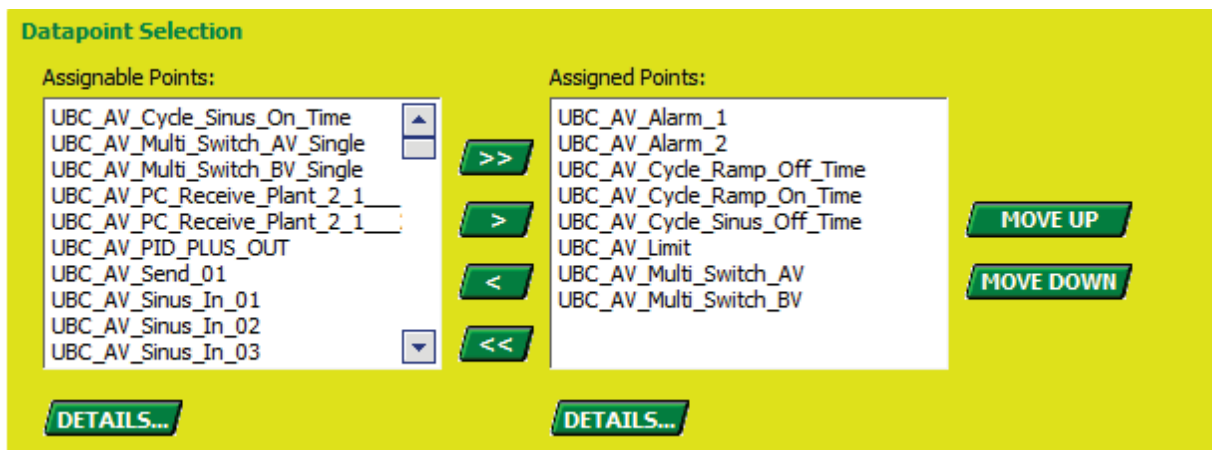

7. Select points you want to be assigned by doing the following:
 - a. In the *Assigned Points* list, highlight the points to be moved. Multiselection by using the CTRL or the SHIFT key is possible.
 - b. Click the SINGLE ARROW button with right direction.
 - Or,
 - c. To move all points in one step,
 - d. Click the DOUBLE ARROW button with right direction.
8. Click the SUBMIT button to save settings, and then click CLOSE button.
9. Click the BACK button.
10. Under **Summary**, click on the new name, in this case 'Analog Value Points'. The datapoint list is shown.

Fast Access Lists

Summary ?

<input type="checkbox"/> Name	Type
<input type="checkbox"/> Analog Value Points	Selected Points/Parameters
<input type="checkbox"/> DigitalPoints	Datapoint Filter

DELETE **NEW...**

Analog Value Points

Selected Points List ?

Name	Value/Unit	Event State	Type	ALM	FLT	OOS	Description	OVR
UBC_AV_Alarm_1	0.00 K	Low Limit	AV	<input checked="" type="checkbox"/>	<input type="checkbox"/>	<input type="checkbox"/>		<input type="checkbox"/>
UBC_AV_Alarm_2	0.00 K	Low Limit	AV	<input checked="" type="checkbox"/>	<input type="checkbox"/>	<input type="checkbox"/>		<input type="checkbox"/>
UBC_AV_Cycle_Ramp_Off_Time	300.00	Normal	AV	<input type="checkbox"/>	<input type="checkbox"/>	<input type="checkbox"/>		<input type="checkbox"/>
UBC_AV_Cycle_Ramp_On_Time	300.00	Normal	AV	<input type="checkbox"/>	<input type="checkbox"/>	<input type="checkbox"/>		<input type="checkbox"/>
UBC_AV_Cycle_Sinus_Off_Time	15.00	Normal	AV	<input type="checkbox"/>	<input type="checkbox"/>	<input type="checkbox"/>		<input type="checkbox"/>
UBC_AV_Limit	100.00	Normal	AV	<input type="checkbox"/>	<input type="checkbox"/>	<input type="checkbox"/>		<input type="checkbox"/>
UBC_AV_Multi_Switch_AV	0.00 %	Normal	AV	<input type="checkbox"/>	<input type="checkbox"/>	<input type="checkbox"/>	MultiSwitch TP or Ramp	<input type="checkbox"/>
UBC_AV_Multi_Switch_BV	0.00	Normal	AV	<input type="checkbox"/>	<input type="checkbox"/>	<input type="checkbox"/>	MultiSwitch TP or Takt	<input type="checkbox"/>

Selected Parameters List ?

Name	Value/Unit	Symbol Type	Parameter Path
on time	30.00	Cycle	.UBC_Alarming.Alarm_Takt
off time	30.00	Cycle	.UBC_Alarming.Alarm_Takt

< BACK **MODIFY...**

Delete Fast Access List

- Procedure**
1. To delete a single fast access list, click the checkbox at the name and click the DELETE button. To delete all fast access lists, click the top check box and click the DELETE button.
Or,
 2. To delete all fast access lists, click the top check box and click the DELETE button.

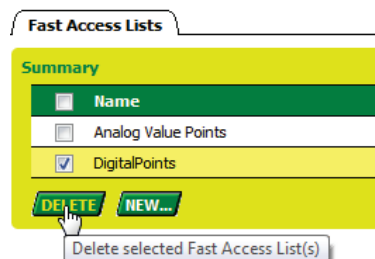

Schedules

Please refer also to the "Time Programs" section, p. 97.

Schedules are daily and weekly time programs, which switch datapoints by setpoints or statuses. Schedules are assigned to plants and each schedule can command datapoints of that plant.

Each schedule specifies a list of datapoint properties to command (switchpoints) on a weekly basis. The week program defines the normal daily activity of the system by specifying which switchpoints are to be commanded each day of the week. The week program applies to a definable time period. There is only one week program per schedule.

Besides the week program, specific programs called exceptions can be created. Exceptions have higher priority than the week program and will overwrite the week program for a definable time period.

View Existing Schedules

- Procedure**
1. In the tree, expand the *Advanced* item, then the *Plants* item and navigate to the plant of which schedules you want to display.
 2. On plant level, click on *Schedules*.

RESULT: On the *Schedules* tab on the right, all existing schedules of the plant are displayed.

The screenshot shows the Eagle Web Interface with the following components:

- Controller Selection:** A dropdown menu set to 'Rambla_C3'.
- Tree View:** A hierarchical tree on the left showing 'MEL_5_3_1' > 'Rambla_C3' > 'Advanced' > 'Plants' > 'UBC_Alarm' > 'Schedules'.
- Schedules Tab:** The active tab on the right, containing:
 - Schedule Filter:** Two radio buttons for 'By Schedule Name' (selected) and 'By Switched Properties'. A search string field with an asterisk (*) and a 'GO' button.
 - Schedule List:** A table with the following data:

Schedule Name	Switched Properties	Description
2012 / 2	UBC_AO_Alarm_1.Present Value	
2013 / 1	UBC_BO_Alarm_1.Present Value	

 Below the table are buttons for 'COPY', 'DELETE', and 'NEW...'.

The column order of the existing schedules can be displayed differently by applying a filter. When selecting **By Schedule Name**, the *Schedule Name* column will be the first column, followed by the *Switched Properties* column. When selecting **By Switched Properties**, the *Switched Properties* column will be the first column, followed by the *Schedule Name* column.

By entering a string in the **Search String** field specific schedules can be displayed. Usage of wildcards (* and ?) is possible.

By default, all schedules will be displayed indicated by the asterisk. A blank filter displays all schedules too. If any text without wildcards is entered, the filter will search for an exact match. The search is case-sensitive.

3. To display specific schedules, enter the appropriate search text.
4. Click the GO Button to apply the filter.

All schedules matching the filter criteria will be displayed under **Existing Schedules**. For each schedule its name, switched properties and the description is displayed.

Schedules can be newly created, edited, copied and deleted.

5. To create a new schedule, click the NEW button.
6. To edit a schedule, click on the schedule name listed in the *Schedule Name* column.
7. To copy a schedule, click the checkbox at the schedule name and click the COPY button.

RESULT: The name of a copied schedule will be replaced with "Copy of <source schedule name>".

After the successful copying we recommend to edit the schedule entries.

8. To delete a schedule, click the checkbox at the schedule name and click the DELETE button. To delete all schedules, click the top checkbox in the title line and click the DELETE button.

NOTE: Schedules are only displayed, if the read access level of the user is equal to or higher than the read access level of the schedule.

Creating, editing, deleting and copying schedules are only possible if:

- the user's access level is higher than the access level for creating, editing, deleting and copying schedules defined in the user administration. Otherwise the NEW, DELETE and COPY buttons are not displayed.
- the user's write access level is equal to or higher than the write access level of the individual schedule.

Create Schedule

- Procedure**
1. On the *Schedules* tab, click the NEW button.

RESULT: The *New / Edit Schedule* dialog box displays.

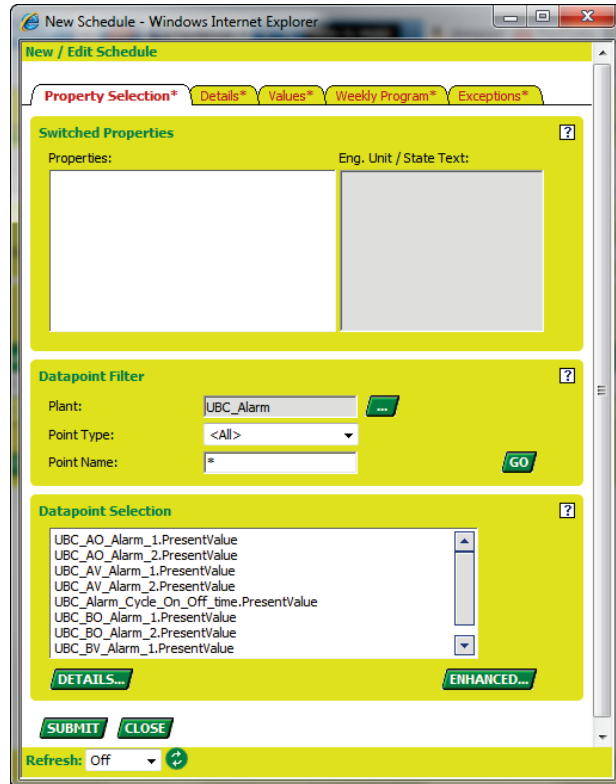

Here you select the datapoints to be switched. In addition, datapoint details can be edited.

Datapoints can be switched in the following two ways:

Standard

Just a single datapoint with its present value property can be switched. By default, a datapoint has the present value property assigned.

Enhanced

Multiple datapoints with their present value property can be switched (accessible via ENHANCED button).

2. Under **Plant**, select plant(s) of which datapoints you want to be filtered by clicking the BROWSE button.
3. Under **Point Type**, select the point type to be filtered.

NOTE: Inputs cannot be switched.

Under **Point Name**, specific datapoint names can be filtered by entering a search text. Wildcards can be used for filtering. By default all datapoints will be displayed as indicated by an asterisk. The filter function is case-sensitive.

4. To display specific datapoint names, enter the desired search text.
5. Click the GO Button to apply the filter.

RESULT: All datapoints matching the filter criteria will be displayed in the list below.

6. Click the datapoint you want to be switched.

RESULT: The datapoint will be inserted in the **Properties** field under **Switched Properties**.

7. To edit a datapoint's details that is selected in the list, click the DETAILS button.

Or,

8. To apply enhanced mode for switching multiple datapoints, click the ENHANCED button.

RESULT: The *Enhanced property selection* dialog box displays.

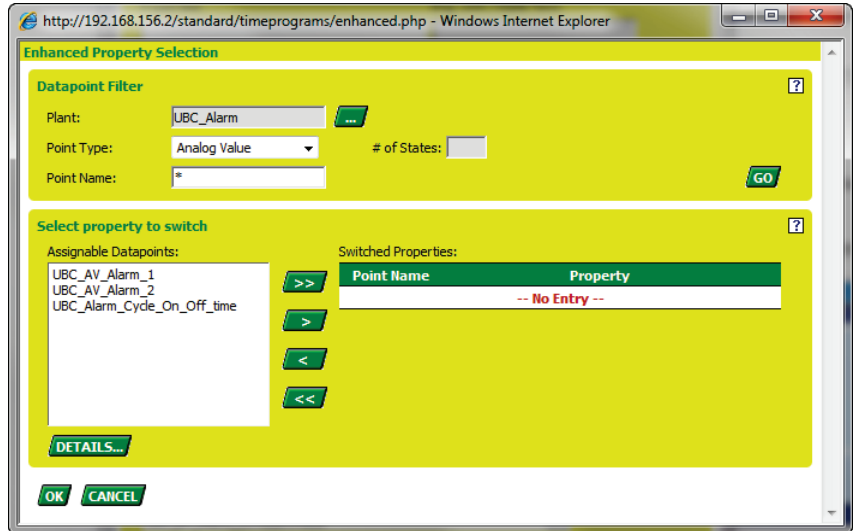

9. Under **Datapoint Filter**, define the filter to display desired datapoints to be switched by doing one of the following:

- a. Under **Plant**, select plant(s) of which datapoints you want to be filtered by clicking the BROWSE button.
- b. Under **Point Type**, select the point type to be filtered.

NOTE: Inputs cannot be switched.

- c. Under **# of States**, enter the number for multi-state points (MO, MV).
- d. Under **Point Name**, specific datapoint names can be filtered by entering a search text. Wildcards can be used for filtering. By default all datapoints will be displayed as indicated by an asterisk. The filter function is case-sensitive. To display specific datapoint names, enter the desired search text.

10. Click the GO Button to apply the filter.

RESULT: All datapoints matching the filter criteria will be displayed in the *Assignable Datapoints* list under **Select Property to Switch**.

11. Under **Assignable Datapoints**, select the datapoints to be switched.

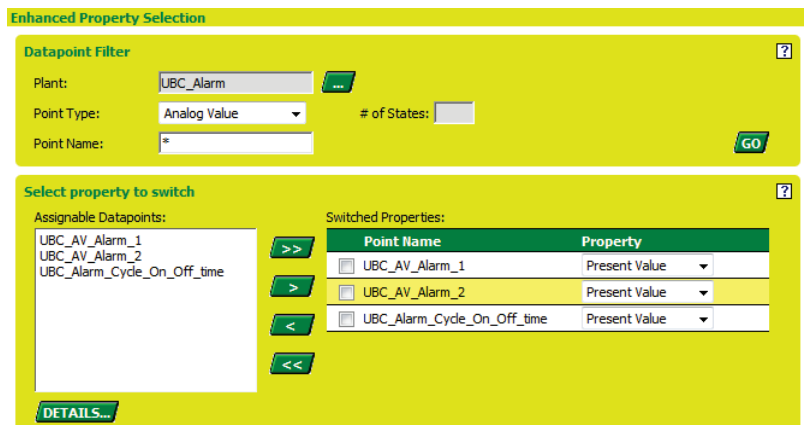

Datapoints are selected/deselected from switching status by moving them between the Assignable Datapoints and the *Switched Properties* list.

12. To move datapoints between lists, that is, to make them switched or not, do one of the following:
 - a. To move single datapoint(s),
Highlight the datapoint(s) to be moved in the *Assignable Datapoints* list. Multiselection by using the CTRL or the SHIFT key is possible.
 - b. Or, click the checkbox at the point name in the *Switched Properties* list.
 - c. Click the SINGLE ARROW button with desired direction.
Or,
 - d. To move all datapoints in one step,
Click the DOUBLE ARROW button with desired direction.

13. Under **Switched Properties**, select the property from the **Property** drop-down list box for each datapoint.

NOTE: Software performs consistency checking for datapoint type, property and engineering unit. This ensures that the engineering unit corresponds to the property to be switched and prevents the same schedule from switching

- datapoints of different types (AO and BO), or
- different properties (e.g. present value and low alarm limit) of the same datapoint, or

If any of these items do not match, the corresponding lines are marked with an inconsistency warning.

14. To save settings, click the OK button.

RESULT: The *New / Edit Schedule* dialog box displays.

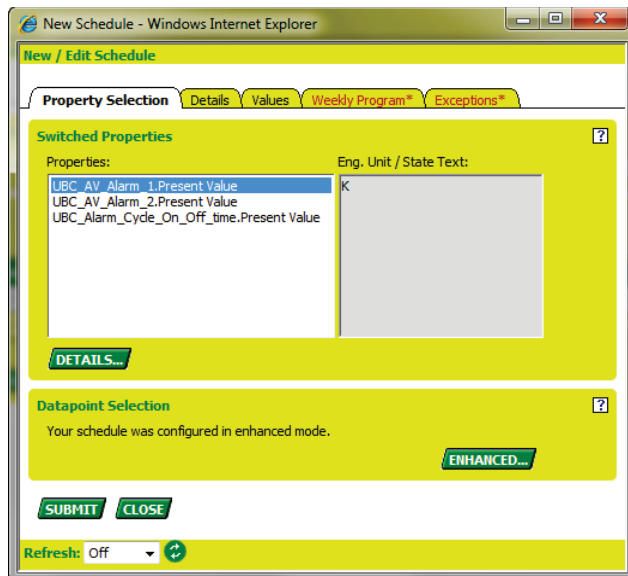

The datapoints to be switched are listed in the **Properties** field under **Switched Properties**.

15. Click the SUBMIT button.
16. Continue by clicking the *Details* tab.

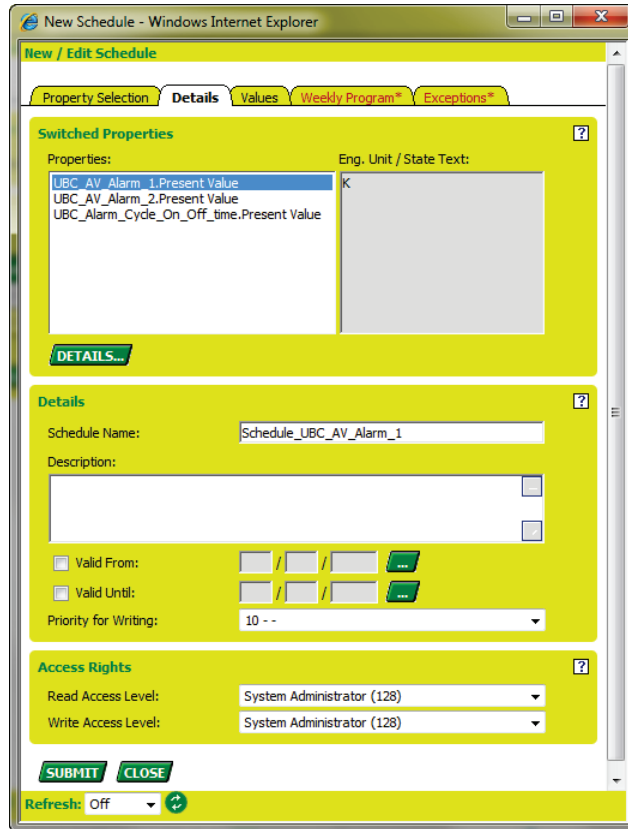

Here you can enter the following details of the schedule:

- Name
- Description
- Valid period
- Priority for writing
- Access rights

17. In the **Schedule Name** field, enter the name for the schedule.
18. In the **Description** field, enter an additional description if desired.
19. The valid period for the schedule will be defined by selecting the start and end date under **Valid From** and **Valid Until**. By default, the schedule is valid one year from the current date on.
20. To define the valid period of the schedule, do the following:
 - Click the **Valid From** checkbox and select the start date from the drop-down list box.
 - NOTE: If the checkbox is unchecked, no start date can be selected. This means that the schedule is valid on any date up to and including the end date.
 - Click the **Valid Until** checkbox and select the end date from the drop-down list box.
 - NOTE: If the checkbox is unchecked, no end date can be selected. This means that the schedule is valid on any date from the start date on.
 - NOTE: If both checkboxes are disabled, the schedule is always valid.

21. From the **Priority for Writing** drop-down list box, select the priority between 9 and 16 (lowest). The priority defines which priority the schedule will have in the BACnet priority array.
22. From the **Read Access level** drop-down list box, select the user level that should have read access for the schedule.

Schedules will only be displayed in the Eagle Web Interface if the read access level of the user is equal to or higher than the read access level of the schedule.

23. From the **Write Access level** drop-down list box, select the user level that should have write access for the schedule.

NOTE: Creating, editing, deleting and copying of schedules in the Eagle Web Interface is only possible if the user's write access level is equal to or higher than the write access level of the schedule.

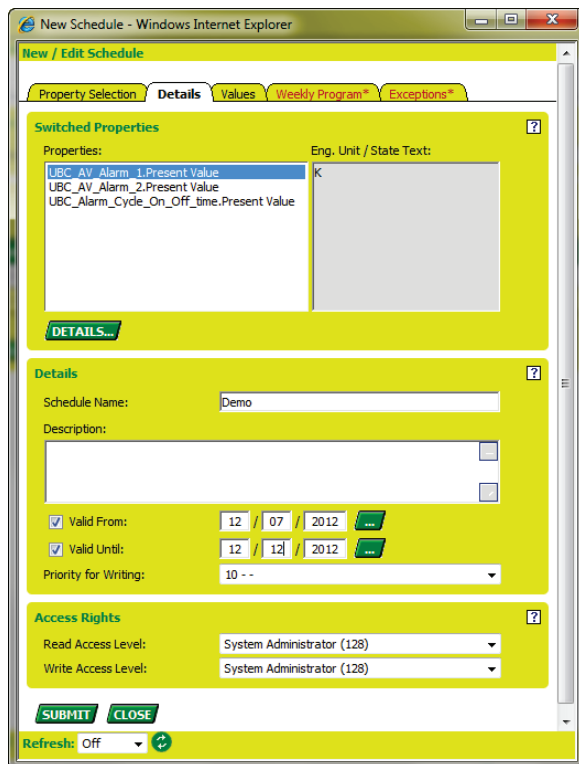

24. Click the SUBMIT button.
25. Continue by clicking the *Values* tab.

Here you can do the following:

- Change details of switched properties (point)
- Define a schedule default value
- Override the present value (Manual)

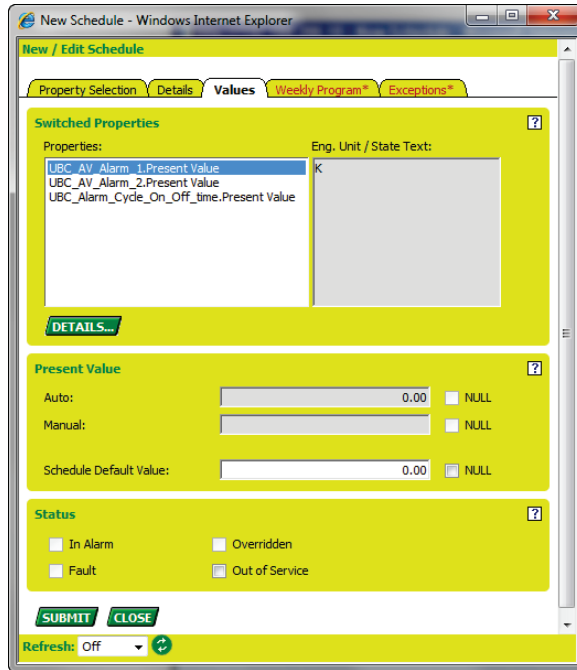

26. To change details of a switched property, click the switched property, then click the DETAILS button, and then change desired value/option on the *Values* tab in the *Details* dialog box of the datapoint.

27. To define a schedule default value, enter the value in the **Schedule Default Value** field, or check the **NULL** checkbox. The schedule default value is used at 12.00 AM as present value of all switched properties when no other value is in effect. The schedule default value can be any value or NULL. The NULL value removes the current value entry of the switched properties from the priority array. Then the next lower value in the priority array becomes the present value of the switched properties.

NOTE: You must enter a schedule default value.

28. To manually override the present value, check the **Out of Service** check box, and then enter the value in the **Manual** field, or check the **NULL** checkbox right to the **Manual** field.

29. Continue by clicking the *Weekly Program* tab.

On the *Weekly Program* tab, you create the weekly program that should be performed during the schedule period defined on the *Details* tab.

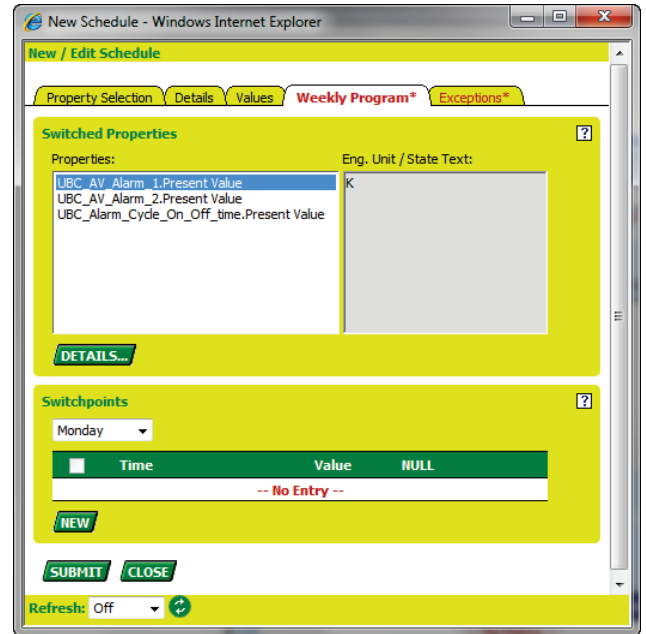

This is done by defining switchpoints. Switchpoints are time-value pairs per day that determine the time when the schedule sets a certain value.

In the *Properties* list under **Switched Properties**, the switched properties are displayed. The corresponding engineering unit / state text of the selected property is shown on the right under **Eng. Unit / State Text**.

To view/edit a datapoint's details selected in the list, click the DETAILS button.

Switchpoints can be defined under **Switchpoints**. Switchpoints can be deleted and copied to other weekdays.

30. Under **Switchpoints**, define switchpoints as follows:
 - a. On top, select the day from the drop-down list box.
 - b. Click the NEW button.
A new row will be inserted.
 - c. Enter the time and value in the corresponding fields.
 - d. Check the **NULL** checkbox if you want to remove the current value at the switching time from the priority array.



NOTE: The switchpoint list must not cover each weekday. If a weekday has duplicate entries, the row is marked.

31. To delete a switchpoint, click the checkbox at the time-value pair row and click the DELETE button.

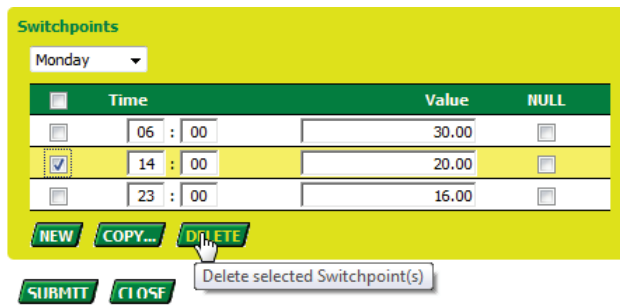

32. To copy a switchpoint, click the checkbox at the time-value pair row and click the COPY button.

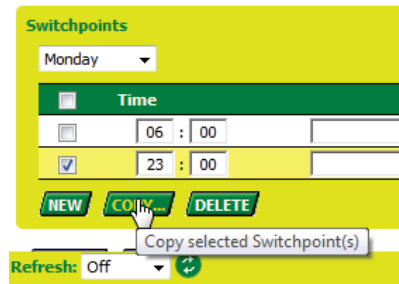

RESULT: The Copy Switchpoints dialog box displays.

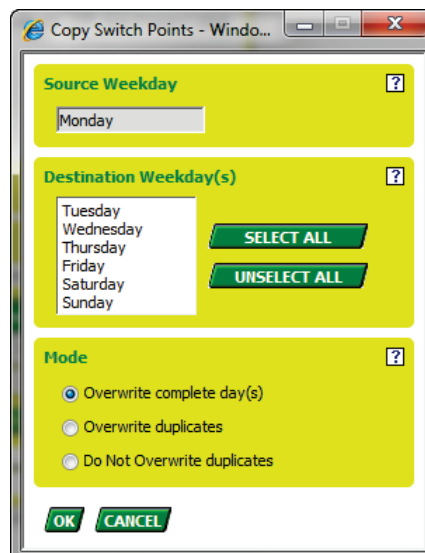

Here you can copy a switchpoint from one single source weekday to one or multiple destination weekdays.

Under **Source Weekday**, the source weekday is displayed. Under **Destination Weekday(s)**, you select the Destination Weekday(s). Under **Mode**, you can define how duplication conflicts should be handled, for example, if the source switchpoint is on 7.00 and the target weekday already contains a switchpoint on 7.00.

33. Under **Destination Weekday(s)**, click the weekday in the list. Multiselection by using the CTRL or the SHIFT key is possible. To select/unselect all points in one step use the SELECT ALL or the UNSELECT ALL button.

34. Under **Mode**, select the mode by clicking the desired radio button at:

- Overwrite complete day(s)
- All existing switchpoints in the destination weekday(s) are deleted

Overwrite duplicates

Destination switchpoints with the same time as the source switchpoint are overwritten by the source switchpoint.

Do not overwrite duplicates

Destination switchpoints with the same time as the source switchpoint are not overwritten by the source switchpoint.

35. To save settings, click the OK button.

RESULT: The *New / Edit Schedule* dialog box redisplay.

36. Click the SUBMIT button.

37. Continue by clicking the *Exceptions* tab.

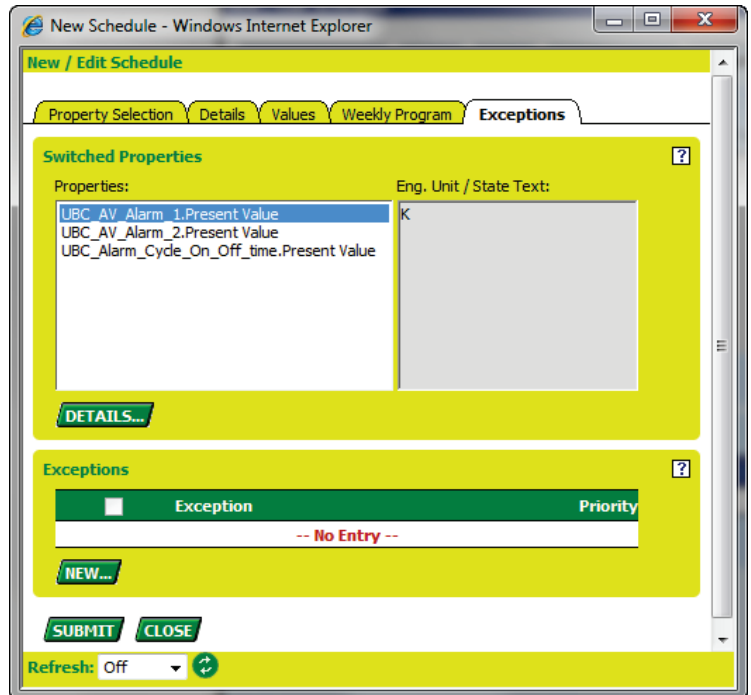

Here you can create, edit, copy and delete exceptions.

An exception is a special daily switching program that differs from the weekly program. Exceptions can have different priorities and each exception will have a higher priority than the weekly program. Exceptions themselves can be prioritized to define the processing sequence in case exceptions have overlapping validity ranges. If the current date enters the valid period of the exception, the exception overwrites the daily program of that day.

In the *Properties* list, the switched properties are displayed. The corresponding engineering unit / state text of the selected property is shown on the right under **Eng. Unit / State Text**.

To view/edit a datapoint's details selected in the list, click the DETAILS button.

38. To create a new exception, click the NEW button.

RESULT: The *New Exception* dialog box displays.

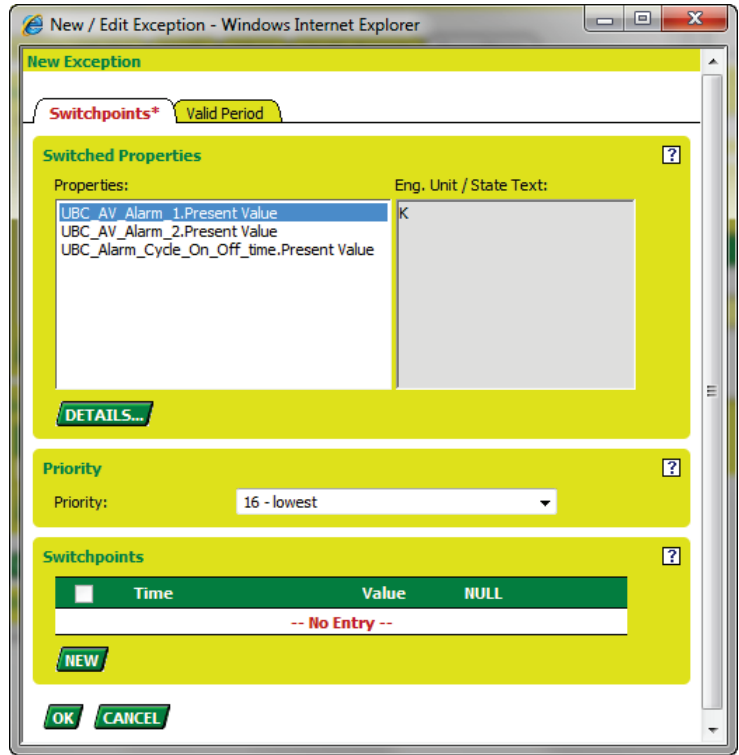

39. From the Priority drop-down listbox, select the priority of the exception. The priority defines the processing sequence in case exceptions have overlapping validity ranges. Priorities are from 1 to 16 (lowest).
40. Define the switchpoints in the same way as described for the week program (starting with step 29). Instead of defining switchpoints per day, you can define a valid period for the exception (see following step).



41. Click on the *Valid Period* tab.

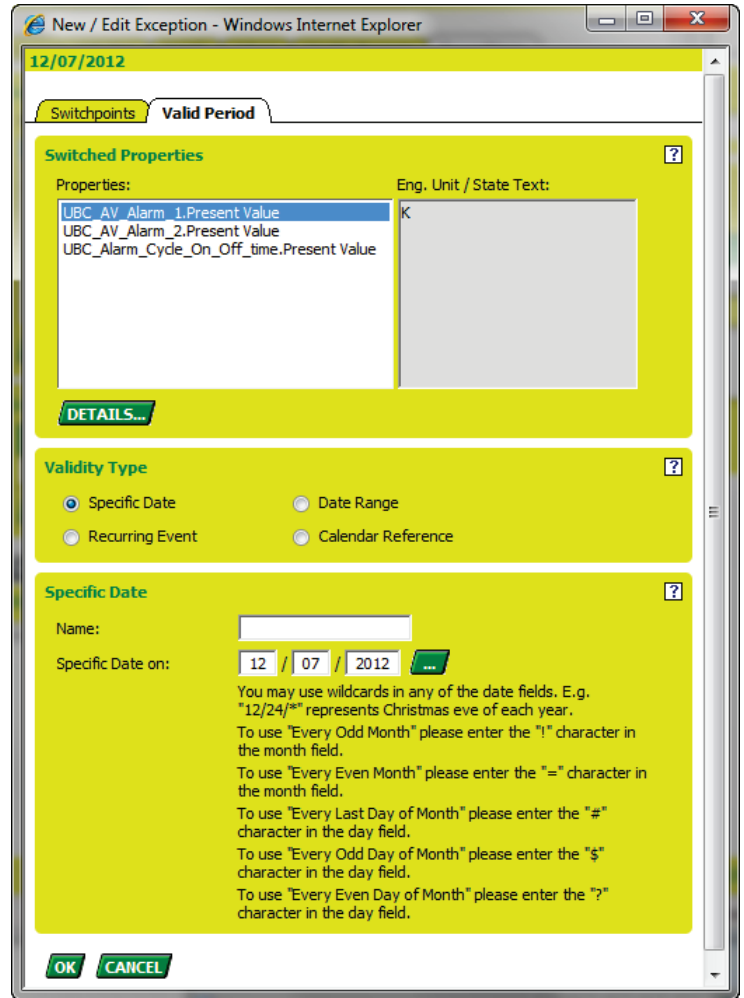

Here you define the valid period for the exception. In the *Properties* list, the switched properties are displayed.

42. Select option by clicking radio button at:

Specific Date

e.g. for May 1th on 01.05.2008

Date Range

e.g. for Summer holidays from 07.21.2008 until 08.09.2008

Recurring Event

e.g. for every last Friday of every Month

Calendar Reference

A project-wide calendar provides dates, e.g. regional holidays and public/religious festivals or any other particular date. The time period can be a specific date, a date range or a recurring event.

43. Under **Name**, enter the name of the valid period.

44. In the corresponding fields below, enter the data of the valid period:

Specific Date

Under **Specific Date on**, enter the date or select date by using the BROWSE button. You may use wildcards in any of the fields.

Example: 12/24/* represents Christmas Eve of each year.

Date Range

Click the checkbox at **Date Range from**, respectively **Date Range to**, and enter the date or select date by using the BROWSE button.

Recurring Event
 Under **Recurring on**, select options from the drop-down list boxes.

Example: Validity Type = Date Range

Validity Type ?

Specific Date Date Range
 Recurring Event Calendar Reference

Date Range ?

Name:

Date Range from: / / ...

Date Range to: / / ...

45. Click the OK button to save settings.

RESULT: The *New Schedule* dialog box redisplayes showing the exception on the *Exceptions* tab.

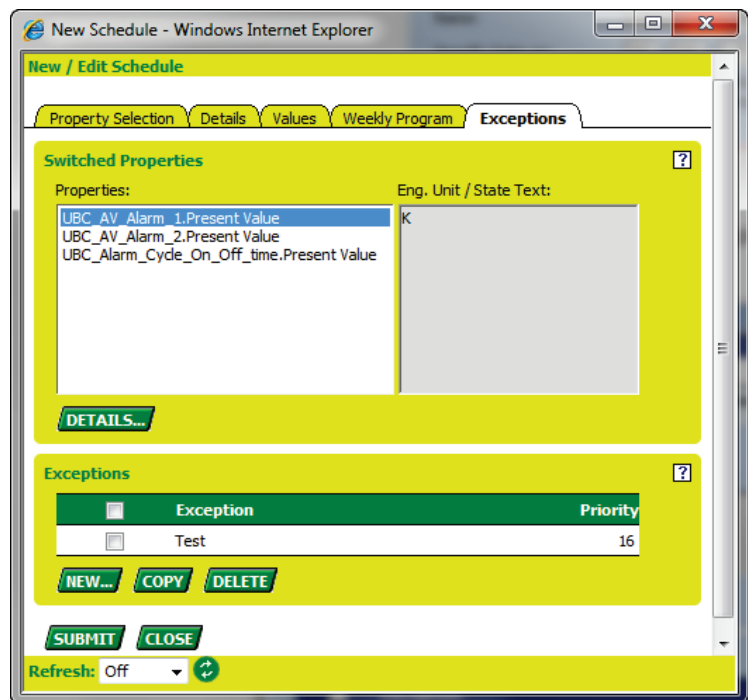

46. To edit an exception, click on the exception in the list.

47. To copy an exception, click the checkbox at the exception and click the COPY button (see Copy Switchpoint description in the Week Program creation).

48. To delete an exception, click the checkbox at the exception and click the DELETE button (see Delete Switchpoint description in the Week Program creation).

49. To finish creating a new schedule, click the SUBMIT button.

RESULT: The new schedule is added to the *Existing Schedules* list on the *Schedules* tab.

MEL_5_3_1.Rambla_C3.Plants.UBC_Alarm.Schedules

Schedules

Schedule Filter

By Schedule Name By Switched Properties Search String:

Schedule List

Entries per Page: 15

Schedule Name	Switched Properties	Description
<input type="checkbox"/> 2012 / 2	UBC_AO_Alarm_1.Present Value	
<input type="checkbox"/> 2013 / 1	UBC_BO_Alarm_1.Present Value	
<input type="checkbox"/> Demo	UBC_Alarm_Cycle_On_Off_time.Present Value UBC_AV_Alarm_1.Present Value UBC_AV_Alarm_2.Present Value	

Page: < | 1 | >

Calendars

Please refer also to the "Time Programs" section, p. 97.

Calendars are assigned to a whole project. They contain exception days or periods, e.g. Christmas, holidays. If controller schedules refer to the same calendar(s), project wide scheduling is possible for these controllers; this is because calendar dates are executed in each controller of the project, which has references to the calendar. Changes in multiple particular controller schedules can be quickly made by simply changing the referenced calendar(s).

View Calendars

- Procedure**
1. In the tree, expand the *Advanced* item and click on Calendars.

RESULT: On the right, the *Calendars* tab displays showing all existing calendars.

Controller Selection: Rambla_C3

MEL_5_3_1.Calendars

Calendars

Calendar List

Entries per Page: 15

Calendar Name	Description	Active
<input type="checkbox"/> Maintenance		<input type="checkbox"/>
<input type="checkbox"/> Summer Holidays 2013		<input type="checkbox"/>
<input type="checkbox"/> Winter Holidays 2013		<input type="checkbox"/>

Page: < | 1 | >

All changes done to a calendar on this controller level will be synchronized with all other controllers of the same project.

For each calendar the following properties are shown:

Calendar Name

Description

Active

Shows whether the current date is within the date range of any of the calendars' entries or not, that is, whether the calendar impacts the current date or not.

Calendars can be edited, copied, deleted and newly created. For each calendar, the referenced schedules can be viewed.

2. To edit a calendar, click on the calendar name listed in the *Calendar Name* column.
3. To create a new calendar, click the NEW button.
4. To copy a calendar, click the checkbox at the calendar name and click the COPY button. The name of a copied calendar will be replaced with "Copy of <source calendar name>". After successful copying we recommend editing the calendar entries.
5. To delete a calendar, click the checkbox at the calendar name and click the DELETE button.

Or,

to delete all calendars, click the top checkbox in the title line and click the DELETE button.

6. To show referenced schedules of a calendar, click the checkbox at the calendar name and click the SHOW REFERENCES button.

NOTE: Calendars are only displayed if the read access level of the user is equal to or higher than the read access level of the calendar.

Creating, editing, deleting and copying calendars are only possible if:

- the user's access level is higher than the access level for creating, editing, deleting and copying calendars defined in the user administration. Otherwise the NEW, DELETE and COPY buttons are not displayed.
- the user's write access level is equal to or higher than the write access level of the individual calendar.

Create Calendar

Procedure

1. In the tree, expand the *Advanced* item and click on Calendars.

RESULT: On the right, the *Calendars* tab shows all existing calendars.

2. Click the NEW button.

RESULT: The *New Calendar* dialog box displays.

3. In the **Name** field, enter a name for the calendar.
4. In the **Description** field, enter a description for the calendar if desired.
5. From the **Read Access Level** and **Write Access Level** drop-down list boxes, select the user levels that should have read and write access of the calendar.

NOTE: A calendar entry will only be displayed if the read access level of the user is higher than the read access level of the calendar.
 A calendar entry can only be edited or deleted if the write access level of the user is higher than the write access level of the calendar.

6. Click the NEW ENTRY button.

RESULT: The *New / Edit Calendar Entry* dialog box displays.

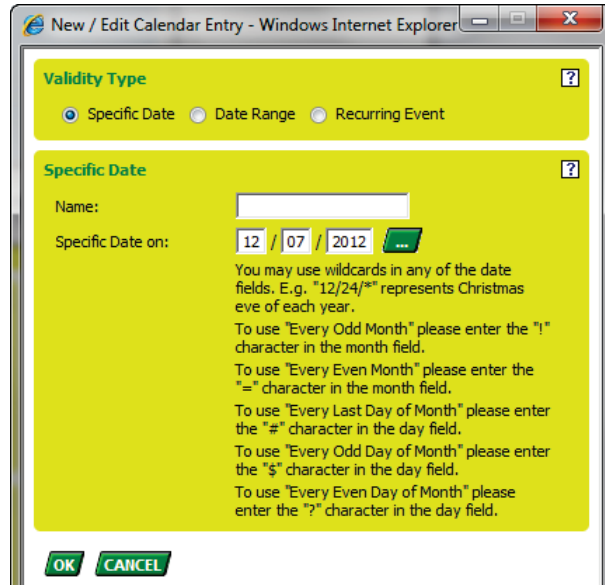

7. Under **Validity Type**, you can define the valid period for the new calendar entry.

8. Select option by clicking radio button at:

- Specific Date
e.g. for Christmas Eve on 24.12.2004
- Date Range
e.g. for Summer holidays from 27.07.2004 until 09.09.2004
- Recurring Event
e.g. for every last Friday of every Month

9. Under **Name**, enter the name of the valid period.

10. In the corresponding fields below, enter the data of the valid period:

Specific Date

Under **Specific Date on**, enter the date or select date by using the BROWSE button. You may use wildcards in any of the fields.

Example: 12/24/* represents Christmas Eve of each year.

Date Range

Click the checkbox at **Date Range from**, respectively **Date Range to**, and enter the date or select date by using the BROWSE button.

Recurring Event

Under **Recurring on**, select options from the drop-down list boxes.

Example: Valid period = Recurring Event

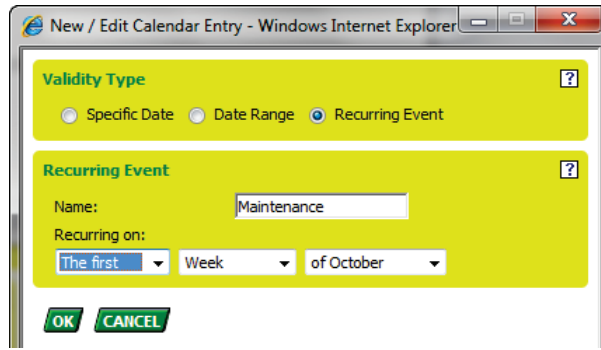

11. Click the OK button.

RESULT: The New Calendar dialog box redisplay and the new entry is inserted under **List of Dates**.

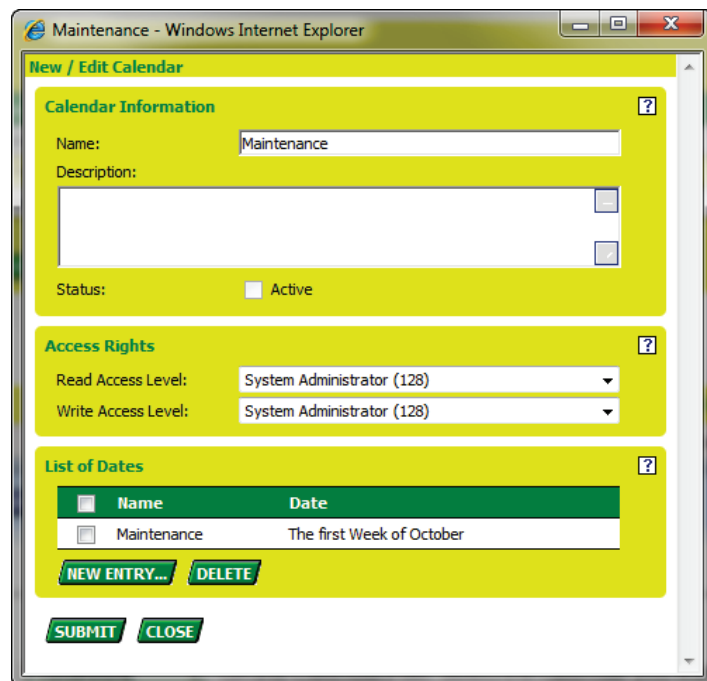

12. Click the SUBMIT button, and then click the CLOSE button.

RESULT: The Calendar is displayed on the *Calendars* tab.

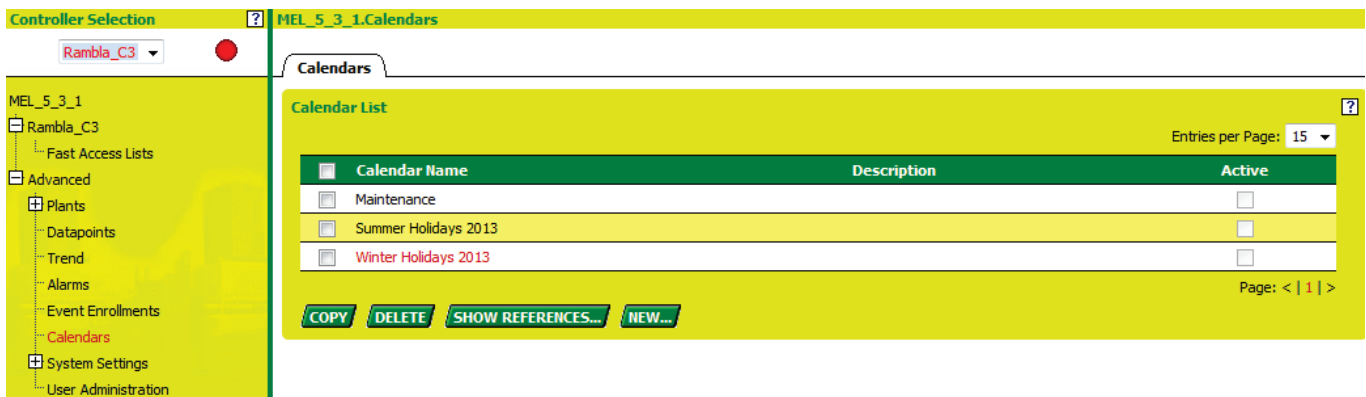

Copy Calendar

- Procedure**
1. On the *Calendars* tab, select the calendar you want to copy by checking the check bar at the calendar name.

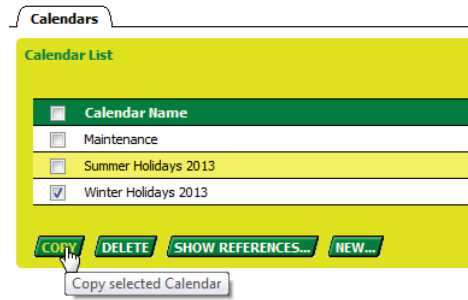

2. Click the COPY button.

RESULT: A copy of the selected calendar is added to the existing calendars.

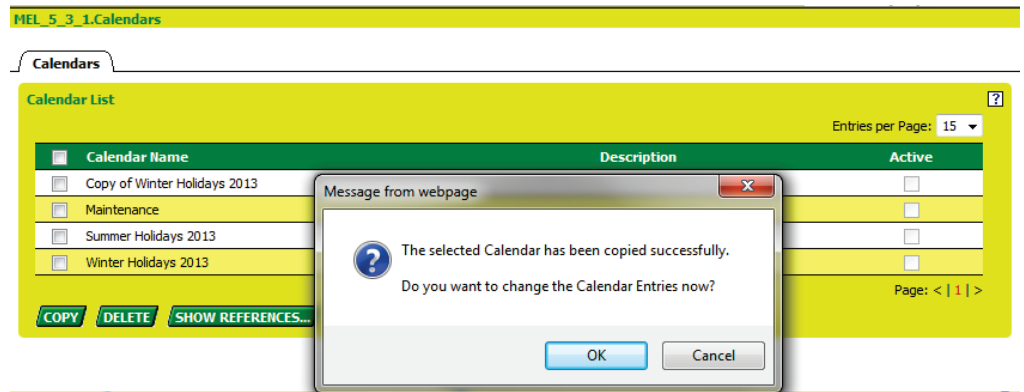

3. Confirm the message box and change the calendar entries in the dialog box displayed. For information on how to change calendar entries, please refer to the "Edit Calendar" section.

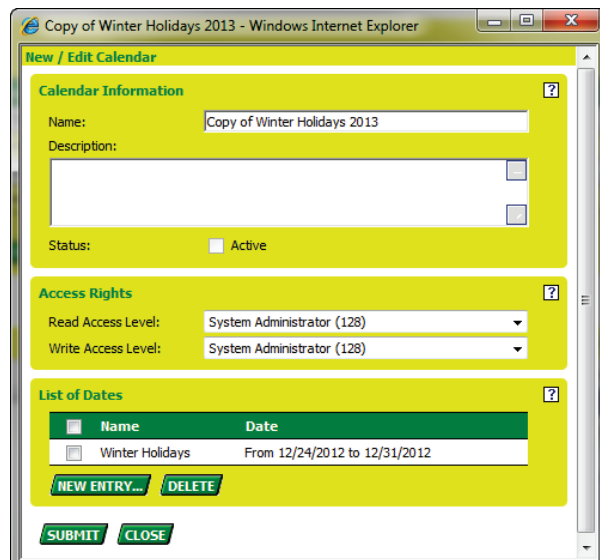

Edit Calendar

- Procedure**
1. In the *Calendar Name* column on the *Calendars* tab, click on the calendar you want to edit.



RESULT: The *New / Edit Calendar* dialog box displays.

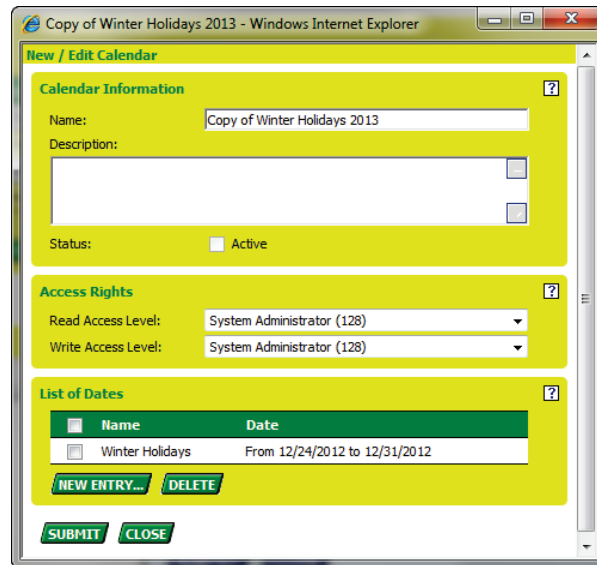

Here, general information such as name, description and active state is displayed. The name and description can be changed. In addition, access rights can be defined for the calendar and the list of dates can be edited by deleting entries and creating new entries. The **Status** field shows whether the current date is within the date range of any of the calendars' entries, that is whether the calendar impacts the current date or not.

2. To edit the calendar name, click in the **Name** field and enter a new name.
3. To edit the calendar description, click in the **Description** field and enter a new description.

New / Edit Calendar

Calendar Information [?]

Name:

Description:

Status: Active

Access Rights [?]

Read Access Level:

Write Access Level:

List of Dates [?]

<input type="checkbox"/>	Name	Date
<input type="checkbox"/>	Winter Holidays	From 12/24/2012 to 12/31/2012

NEW ENTRY... **DELETE**

SUBMIT **CLOSE**

4. To change read or write access levels, select different levels from the **Read Access Level** respectively **Write Access Level** drop-down list boxes.

5. Under **List of Dates**, you can edit, delete and create new calendar entries.

NOTE: A calendar entry will only be displayed if the read access level of the user is higher than the read access level of the calendar.
A calendar entry can only be edited or deleted, if the write access level of the user is higher than the write access level of the calendar.

6. To edit a calendar entry, click on the entry in the *Date* column and change the entry data in the *New / Edit Calendar Entry* dialog box. For detailed information on fields and functions in this dialog box, please refer to the "Create New Calendar" section.

New / Edit Calendar

Calendar Information [?]

Name:

Description:

Status: Active

Access Rights [?]

Read Access Level:

Write Access Level:

List of Dates [?]

<input type="checkbox"/>	Name	Date
<input type="checkbox"/>	Winter Holidays	From 12/24/2012 to 12/31/2012

NEW ENTRY... **DELETE**

SUBMIT **CLOSE**

7. To delete a calendar entry, click the checkbox at the entry name and click the DELETE button.

Or, to delete all calendar entries, click the top checkbox in the table heading and click the DELETE button.

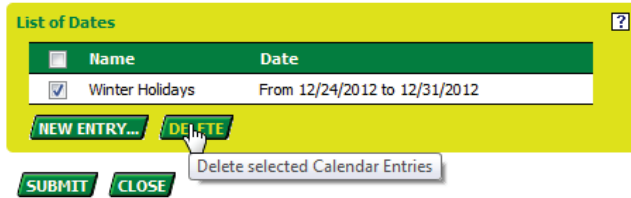

- 8. To create a new calendar entry, click the NEW ENTRY button. For detailed information, please refer to the "Create New Calendar" section.
- 9. After finishing with the changes, click the SUBMIT button.

RESULT: The New / Edit Calendar dialog box redisplay.

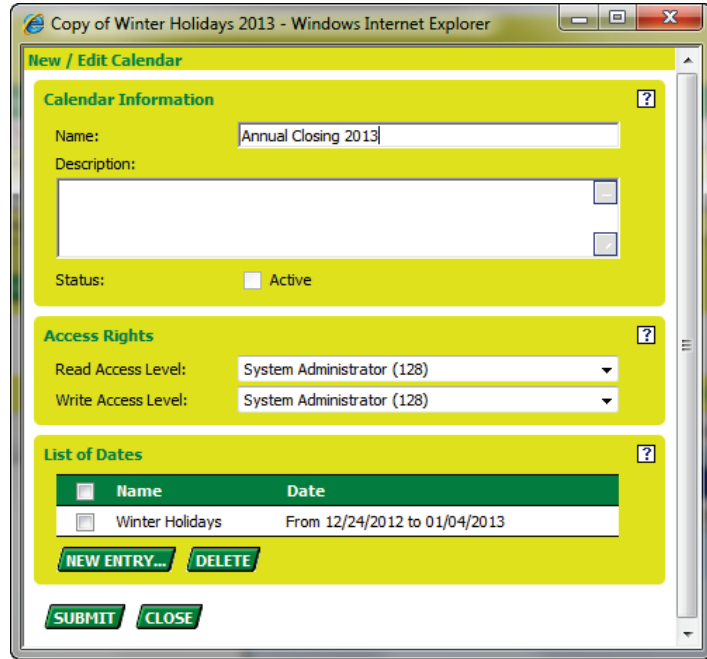

- 10. Click the SUBMIT button, and then click the CLOSE button.

RESULT: The copied calendar is added to the Calendar List.

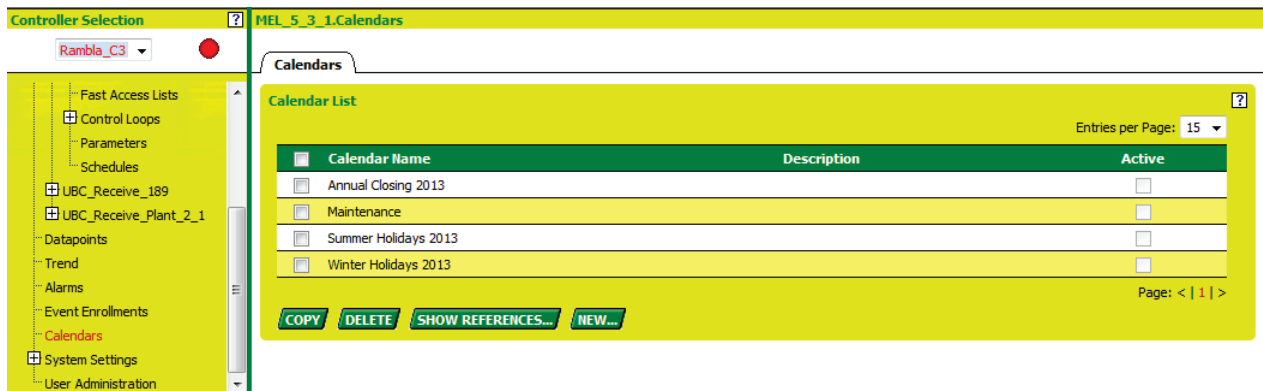

Delete Calendar

- Procedure**
1. To delete a calendar, click the checkbox at the calendar name and click the DELETE button.
- Or,
2. To delete all calendars, click the top checkbox in the title line and click the DELETE button.

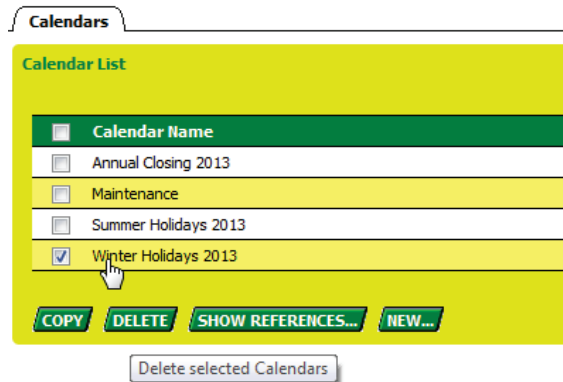

Show Calendar References

- Procedure**
1. On the *Calendars* tab, select the calendar the references of which you want to show by checking the check bar at the calendar name.

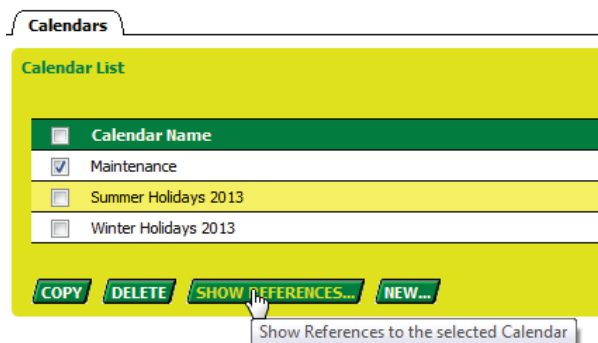

RESULT: The *Calendar References* dialog box displays showing all schedules which reference via exceptions to the selected calendar. The controller, to which the schedule is assigned, is also shown. You can view detailed information of the exception and edit the exception by clicking on the schedule in the *Schedule Name* column. For detailed information on how to edit a referencing exception of a schedule, please refer to the *Exception* tab description (3) of the "Create New Schedule" section.

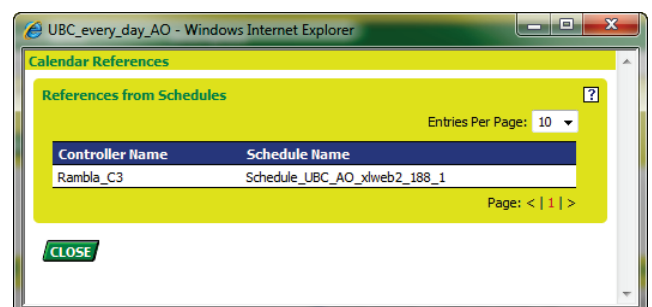

Datapoints

Please refer also to the "Time Programs" section, p. 23.

View Datapoint List

Datapoint lists can be displayed for all plants or for a particular plant.

Datapoint Filter

Plant: Points in Alarm Points in Manual

Type:

All Types

Analog Input (AI) Binary Input (BI) Multi-State Input (MI) Pulse Converter (PC) Reference Input (RI)

Analog Output (AO) Binary Output (BO) Multi-State Output (MO) Reference Output (RO)

Analog Value (AV) Binary Value (BV) Multi-State Value (MV) Flag Point (FP)

Name:

Datapoint List

Sort by: Entries per Page: 15

Name	Description	Value/Unit	Event State	Type	ALM	FLT	OVR	OOS
UBC_AI1		8.00 V	Normal	AI	<input type="checkbox"/>	<input type="checkbox"/>	<input type="checkbox"/>	<input checked="" type="checkbox"/>
UBC_AI2		9.00 V	Normal	AI	<input type="checkbox"/>	<input type="checkbox"/>	<input type="checkbox"/>	<input checked="" type="checkbox"/>
UBC_AITemp		0.00 °C	Fault	AI	<input checked="" type="checkbox"/>	<input checked="" type="checkbox"/>	<input type="checkbox"/>	<input type="checkbox"/>
UBC_AI_xlweb2_188_1		8.92 V	Normal	AI	<input type="checkbox"/>	<input type="checkbox"/>	<input type="checkbox"/>	<input type="checkbox"/>
UBC_AI_xlweb2_188_2		8.91 V	Normal	AI	<input type="checkbox"/>	<input type="checkbox"/>	<input type="checkbox"/>	<input type="checkbox"/>
UBC_AO_Alarm_1		12.00 %	Normal	AO	<input type="checkbox"/>	<input type="checkbox"/>	<input checked="" type="checkbox"/>	<input type="checkbox"/>
UBC_AO_Alarm_2		0.00 %	Low Limit	AO	<input checked="" type="checkbox"/>	<input type="checkbox"/>	<input type="checkbox"/>	<input type="checkbox"/>
UBC_AO_SpaceTemp		15.00 °C	Normal	AO	<input type="checkbox"/>	<input type="checkbox"/>	<input type="checkbox"/>	<input type="checkbox"/>
UBC_AO_xlweb2_188_1		75.00 %	Normal	AO	<input type="checkbox"/>	<input type="checkbox"/>	<input type="checkbox"/>	<input type="checkbox"/>
UBC_AO_xlweb2_188_2		75.00 %	Normal	AO	<input type="checkbox"/>	<input type="checkbox"/>	<input type="checkbox"/>	<input type="checkbox"/>
UBC_AV_Alarm_1		0.00 K	Low Limit	AV	<input checked="" type="checkbox"/>	<input type="checkbox"/>	<input type="checkbox"/>	<input type="checkbox"/>
UBC_AV_Alarm_2		0.00 K	Low Limit	AV	<input checked="" type="checkbox"/>	<input type="checkbox"/>	<input type="checkbox"/>	<input type="checkbox"/>
UBC_AV_Cycle_Ramp_Off_Time		300.00	Normal	AV	<input type="checkbox"/>	<input type="checkbox"/>	<input type="checkbox"/>	<input type="checkbox"/>
UBC_AV_Cycle_Ramp_On_Time		300.00	Normal	AV	<input type="checkbox"/>	<input type="checkbox"/>	<input type="checkbox"/>	<input type="checkbox"/>
UBC_AV_Cycle_Sinus_Off_Time		15.00	Normal	AV	<input type="checkbox"/>	<input type="checkbox"/>	<input type="checkbox"/>	<input type="checkbox"/>

Page: < 1 | 2 | 3 | 4 | 5 | 6 | 7 ... 43 | >

Procedure

1. In the tree, expand the *Advanced* item and navigate to the *Datapoints* item, either on level of all plants or on level of a particular single plant.

2. In the tree, click on Datapoints.

RESULT: On the right, the datapoints are listed on the *Datapoints* tab. You can display specific datapoints and their properties by applying a filter. For each datapoint its details can be viewed and edited.

3. Under **Datapoint Filter**, select the point types that should be displayed, as follows

e. Check **Points in Alarm** or **Points in Manual**.

f. Under **Type**, check/uncheck specific datapoint types to be included/excluded from the filter.

g. Under **Name**, specific datapoint names can be filtered by entering a search text. By default all datapoints will be displayed as indicated by an asterisk. To display specific datapoint (names), enter the appropriate search text.

h. Click the GO Button to apply the filter.

RESULT: In the **Datapoint List**, all datapoints matching the filter criteria will be displayed.

NOTE: Only those datapoints can be displayed of which read access level is equal to or lower than the read access level of the user.

Datapoints can have the following properties:

Name

A datapoint's details can be edited by clicking on its name

Value/Unit

Shows the current value with engineering unit (analog datapoint) or state (digital datapoint)

Event State

Shows the transition type

Normal

The alarm is going to normal state, that is, the value of the datapoint remains under the high limit, or exceeds the low limit.

Off-Normal

The alarm reaches off-normal state that the datapoint value exceeds the high limit, or remains under the low limit.

Fault

The alarm originates in a fault such as sensor break, etc.

High Limit

Point value has exceeded the high limit. Special case of the Off-Normal state of analog inputs, analog outputs, and analog values.

Low Limit

Point value has dropped below the low limit. Special case of the Off-Normal state of analog inputs, analog outputs, and analog values.

Type

e.g. AI, AO, etc.

ALM = point is in alarm

FLT = point has a fault

OVR = point value is overridden

OOS = point is out of service

4. To view or edit details of a datapoint, click on the datapoint name.

NOTE: Only those datapoints are displayed and can be edited of which read access level is equal to or lower than the read access level of the user.

5. To sort the list, click the BROWSE button at the **Sort by** field.

View / Edit Datapoint Details

Viewing/editing datapoint details may include the following:

- View general properties such description, point role, LON mapping data, and access rights
- Manually override the present value, that switch between Manual and Auto mode
- Enable/disable alarm reporting
- View alarm status (flags)
- Change COV value
- Change Relinquish Default value
- Enable/disable Off-Normal conditions
- View/edit event enrollment alarming

Continue with the "General Procedure" which describes where the functions will be accessible.

General Procedure

1. On the *Datapoints* tab, click on the datapoint in the *Name* column (see also "View Datapoints List" section).

The screenshot shows a web interface titled 'MEL_5_3_1.Rambla_C3.Datapoints'. It features a 'Datapoints' tab and a 'Datapoint Filter' section. The filter includes a 'Plant' dropdown set to '<All>', a 'Type' section with checkboxes for 'All Types', 'Analog Input (AI)', 'Analog Output (AO)', and 'Analog Value (AV)', and a 'Name' search field. Below the filter is a 'Datapoint List' section with a 'Sort by' dropdown set to 'Name'. The list contains the following entries:

Name
UBC_AI1
UBC_AI2
UBC_AITemp
UBC_AI_xlweb2_188_1
UBC_AI_xlweb2_188_2
UBC_AO_Alarm_1
UBC_AO_Alarm_2
UBC_AO_SpaceTemp
UBC_AO_xlweb2_188_1
UBC_AO_xlweb2_188_2
UBC_AV_Alarm_1
UBC_AV_Alarm_2
UBC_AV_Cycle_Ramp_Off_Time
UBC_AV_Cycle_Ramp_On_Time
UBC_AV_Cycle_Sinus_Off_Time

RESULT: The *Details* dialog box of the selected datapoint displays.

Example: Analog Input Details of AI.

By default, the *Values* tab is selected.

2. View / change desired datapoint details by selecting the desired tab, of which functions are described in the following:

General

Shows general properties such as description, LON mapping data, and access rights
See "View General Properties" section as follows.

Alarming

Enable/disable alarm reporting
Enable/disable Off-Normal conditions
See "View / Edit Alarming" section as follows.

Values

Manually override the present value, that switch between Manual and Auto mode
View alarm status (flags)
Change COV value
See "View / Edit Values" section in the following.

Command Priorities

Change Relinquish Default value

See "View / Edit Command Priorities" section as follows.

Event Enrollments

View/Edit event enrollment alarming

See "View / Edit Event Enrollment Alarmings" section as follows.

View General Properties

- Procedure** 1. In the *Details* dialog box of the selected datapoint, select the *General* tab.

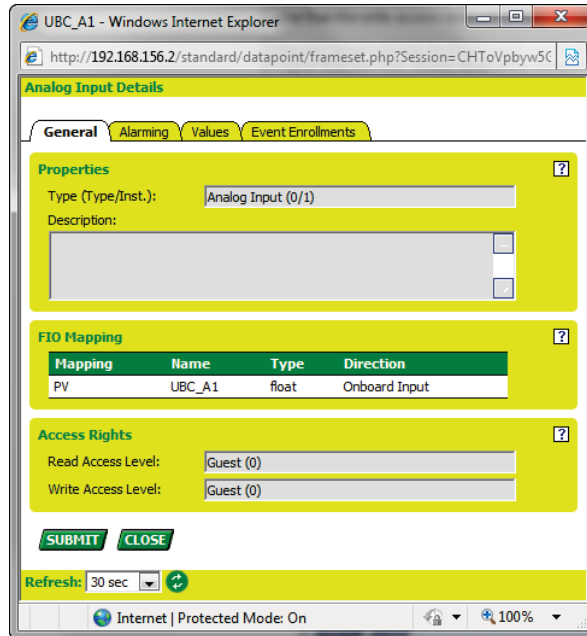

Here the following datapoint details are shown:

Properties

Type

Shows datapoint type, e.g. analog input, binary input etc.

#States

Shows the number of states of a multi-state datapoint (applies to MI, MO, MV datapoints only).

Description

Shows a detailed description

FIO Mapping

Here you can view Mapping details such as:

Mapping

Shows the Mapping type, e.g. PV = Present Value

Name / NV Name

Shows the name of the datapoint, or NV name of LON points

Type / NV Type

Shows the datapoint type (e.g. float, unit32) or the NV type of LON points, e.g. SNVT_temp

Direction

Shows the type of direction, input or output of the datapoint (onboard and panel bus I/Os only).

For LON Points the corresponding NV, e.g. NV in is displayed.

Access Rights

Shows the read and write access level of the datapoint.

To write values to a datapoint, you must have a write access level equal or higher than the write access level of the datapoint.

Datapoint details will only be displayed if you have a read access level equal to or higher than the read access level of the datapoint.

2. Click the SUBMIT button to save settings.
3. To view /edit alarming details, click on the *Alarming* tab (see "View / Edit Alarming" section).

View / Edit Alarming

- Procedure** 1. In the *Details* dialog box of the selected datapoint, select the *Alarming* tab.

Analog Input Details

General
Alarming
Values
Event Enrollments

Intrinsic Reporting ?

Notification Class: ▾

Notify Type:

Transitions:

Event	Reporting	Ackn.	Last Transition
To-Off Normal	<input checked="" type="checkbox"/>	<input checked="" type="checkbox"/>	*/**/* *.*:*
Back-To Normal	<input checked="" type="checkbox"/>	<input checked="" type="checkbox"/>	*/**/* *.*:*
To Fault	<input checked="" type="checkbox"/>	<input checked="" type="checkbox"/>	05/20/2017 21:02:50

Inhibit Fault:

Off-Normal Conditions ?

High Limit Enable: °C

Low Limit Enable: °C

Dead Band: °C

Suppress Alarm:

Alarm Delay: s

Back-To Normal: s

SUBMIT
CLOSE

Here you can enable/disable alarm reporting and Off-Normal conditions, select a different notification class and view alarm information.

Intrinsic Reporting

Intrinsic Reporting means, that only the present value property is to be considered for alarming.

Notification Class

Shows the name of the notification class. You can change the notification class by selecting another notification class from the drop-down listbox.

Alarm Type

By default all alarms are of the type 'event'.

Transitions

Here the following data about transitions are shown:

Event

Shows the transition types that can be selected for reporting:

- Back To-Normal
The alarm is going to normal state, that is, the value of the datapoint remains under the high limit, or exceeds the low limit.
- To Off-Normal
The alarm reaches off-normal state, that is, the datapoint value exceeds the high limit, or remains under the low limit.
- To Fault
The alarm originates in a fault such as sensor break, etc. (depends on point type)

Reporting

Check the transition type you want to be reported, that is, which transition should be saved in the alarm buffer and in the alarm list.

Ackn.

Each transition will be acknowledged (checked) by default.

Last Transition

Shows the date when the last transition has occurred.

Off-Normal Conditions

Here you can define/change the conditions, which set off an Off-Normal event. The Off-Normal conditions depend on the point type.

High Limit Enable (applies to AI, AO, AV, and PC datapoints only)

If a high limit is exceeded and this condition remains present for at least the defined alarm delay (time), than an alarm of event type 'To-Off-Normal' is set off. To set a high limit, click checkbox and enter value into the field.

Low Limit Enable (applies to AI, AO, AV, PC datapoints only)

If the present value falls below the low limit and this condition remains present for at least the defined alarm delay (time), than an alarm of event type 'To-Off-Normal' is set off. To set a high limit, click checkbox and enter value into the field.

To set a low limit, click checkbox and enter value into the field.

Deadband (applies to AI, AO, AV datapoints only)

In order to set off an alarm of event type 'To-Off-Normal', for at least the defined alarm delay (time) the present value must remain within the range: low limit plus deadband and high limit minus deadband.

Enter deadband value.

Suppress alarm (applies to all datapoint types)

Enables/disables alarming.

Alarm Delay (applies to all datapoint types, except PC datapoint)

Defines the time delay with which the 'To-Off-Normal' event will be set off.

Enter alarm delay value.

Alarm Value Enable (applies to BI and BV datapoint types only)
 Here you can select the alarm value (status), e.g. 0 or 1, ON or OFF, Up or Down, when an alarm should be reported in case of binary input changes. In addition an alarm delay can be entered in the **Alarm Delay** field.

Check the **Alarm Value Enable** checkbox and select desired value from the drop-down list box.

Suppress alarm (applies to all datapoint types)
 Enables/disables alarming.

Alarm Delay (applies to all datapoint types, except PC datapoint)
 Defines the time delay with which the 'To-Off-Normal' event will be set off.

Enter alarm delay value.

State Text	Is Alarm Condition	Is Fault Condition
OFF (1)	<input type="checkbox"/>	<input type="checkbox"/>
AUTO (2)	<input type="checkbox"/>	<input type="checkbox"/>
STAGE 1 (3)	<input type="checkbox"/>	<input type="checkbox"/>
STAGE 2 (4)	<input type="checkbox"/>	<input type="checkbox"/>
STAGE 3 (5)	<input type="checkbox"/>	<input type="checkbox"/>

Alarming Enabled:

Alarm Delay: s

State Text, Is Alarm Condition, Is Fault Condition
 (applies to MI and MV datapoint type only)

For Multi-State Inputs and Multi-State Value datapoints you can define the states which represent and set off an 'Off-Normal' and/or a 'Fault' event.

Each state can be set for setting off a 'To-Off-Normal' and/or a 'Fault' event.

For each state, check the conditions by clicking the corresponding radio button.

Suppress alarm (applies to all datapoint types)
 Enables/disables alarming.

Alarm Delay (applies to all datapoint types, except PC datapoint)
 Defines the time delay with which the 'To-Off-Normal' event will be set off.

Enter alarm delay value.

2. Click the SUBMIT button to save settings.
3. To view /edit datapoint values, click on the *Values* tab (see "View / Edit Values" section).

View / Edit Values

- Procedure** 1. In the *Details* dialog box of the selected datapoint, select the *Values* tab.

Analog Input Details

General Alarming **Values** Event Enrollments

Present Value ?

Auto: V
 Manual: V
 Minimum Present Value: V
 Maximum Present Value: V
 Characteristic:
 Resolution:
 Reliability:
 Safety Value: Last valid value
 V
 Sensor Offset: V

Status ?

In Alarm Overridden
 Fault Out of Service

Change of Value ?

Increment: V

SUBMIT **CLOSE**

Refresh:

Here you can manually override the present value, that is, switch between Manual and Auto mode and vice versa, view alarm status (flags) and change the COV value.

Present Value

Here you can set the datapoint's "operation mode", to auto or manual. In addition the hardware reliability (sensor breaks), the characteristic and further properties of the physical input is shown.

Auto (applies to all datapoint types)

In Auto operation mode (Auto=checked), the datapoint shows the current value of the datapoint.

Manual (applies to all datapoint types)

In Manual mode, the current datapoint value can be overwritten.

To override the current value, click the **Manual Override** radio button and enter the value into the field.

NOTE: When an AI datapoint is set into Manual mode and its value will be overwritten, the 'overridden' and 'out of service' flag will be set (see Status). The set out of service flag indicates that the datapoint is decoupled from the physical input (sensor) to prevent a sensor value

from instantly overwriting the manual value in the next scan cycle.

NOTE: When an AO datapoint is set into Manual mode, its current value will be overwritten by the manual value that has a higher priority (8). As long as no other process of higher priority writes to the analog output, the manual value is present. The overridden flag will be set (see Status).

Minimum Present Value

Defines the minimum value of the graphical bar display in the EBI. Defaults to the Low Limit Reporting value

Maximum Present Value

Defines the maximum value of the graphical bar display in the EBI. Defaults to the Low Limit Reporting value

Characteristic

Shows the name of the characteristic

Resolution

Shows the resolution which defines the smallest recognizable change of the present value. The smaller the value the more precise a value change can be recognized.

Reliability

Shows whether the hardware assigned to the datapoint is in proper condition or not. Depending on the datapoint type, the following conditions may be displayed:

No Error Detected	Loop is in proper condition, that is, present value is reliable; that is, no other fault has been detected.
No Sensor	Sensor may be not connected
No Output	Hardware may be not connected
Unreliable Other	The controller has detected that the present value is unreliable, but none of the other conditions describe the nature of the problem. A generic fault other than those listed above has been detected, e.g., a Binary Input is not cycling as expected.

NOTE:

For binary output datapoints, the reliability will work only if the service type of the corresponding NVo in CARE is set to 'acknowledged'

Safety Value

Shows the safety value, to which the point will command the device in case of communication failure or application stop

Sensor Offset (applies to onboard I/Os)

You can enter or change the sensor offset value

Feedback Value (applies to BO and MO datapoints only)

Defines the datapoint that should provide the value for feedback control in case of BACnet fault and command failure alarms. The feedback point must be an input of the same type. The selected feedback point will not be available on the controller HMI and web interface.

NOTE:

The feedback point must not be used in a control loop since as a result the control loop will not be executed properly.

Use as Setpoint (applies to AV, BV and MV datapoints only).

If in CARE this property is set for a datapoint, the **Use as Setpoint** field will be displayed in the HTML Interface and on the controller HMI for overwriting the present value without the necessity of setting the datapoint into manual mode before. Instead, the present value can be overwritten quickly by

entering the value in the **Use as Setpoint** field displayed in the corresponding interface.

NOTE: The field will not be available in the HTML Interface and on the controller HMI if the property is not selected in CARE.

Manual Life Safety (applies to AO, BO, MO datapoints only)
Shows the status of the manual override switch or potentiometer of the LON module.

Resolution
Shows the resolution which defines the sensitivity for value transmission

Reliability
Shows the reliability (see above)

Direct/Reverse
Shows the polarity (applies to BI and BO datapoints only)
The polarity indicates the relationship between the physical state of the input and the logical state represented by the present value. If the polarity is NORMAL, then the ACTIVE state of the present value is also the ACTIVE or ON state of the physical input. If the polarity is REVERSE, then the ACTIVE state of the present value is the INACTIVE or OFF state of the physical Input.

Polarity	Present Value	Physical State of Input	Physical State of Device
NORMAL	INACTIVE	OFF or INACTIVE	<u>not</u> running
NORMAL	ACTIVE	ON or ACTIVE	running
REVERSE	INACTIVE	ON or ACTIVE	<u>not</u> running
REVERSE	ACTIVE	OFF or INACTIVE	running

Select polarity by clicking corresponding radio button.

Safety Position
You can select the position, to which the point will command the device in case of communication failure or application stop (no response):

Analog Output:

- 0 %
- 50 %
- 100 %
- device is commanded to the selected percentage value
- Remain in current position
- device is commanded to the last valid position

Binary Output:

- logical state depending on state text definition, e.g.: OFF, ON, ALARM, NORMAL, etc.
- device is commanded to the selected logical state
- Remain in current position
- device is commanded to the last valid position

The screenshot shows a yellow background with two settings. The first is 'Change of State Time:' followed by a text input field containing the placeholder '*/*/*, *:*:*'. The second is 'EOH/EOV Optimization:' followed by two radio buttons: 'Yes' (unselected) and 'No' (selected).

Change of State Time

Displays the time when the state has changed the last time

EOH/EOV Optimization (applies to AV, BV, and MV datapoints)

Check whether the datapoint should be optimized (Yes) or not (No), in case the datapoint is used as setpoint for energy optimized heating or ventilation.

In the following fields you can reset the pulse converter (applies to PC datapoint only).

The screenshot shows a yellow background with three settings. The first is 'Present Value:' followed by a text input field containing '0.00'. The second is 'Reset to:' followed by a text input field containing '0.00' and a green 'OK' button. The third is 'Time of last Reset:' followed by a text input field containing the placeholder '*/*/*, *:*:*'.

Present Value

Shows the present value of the pulse converter

Reset To

Enter the desired value and then click OK

Time of last Reset

Shows the time of the last pulse converter reset

Change of State Counter (applies to BI and BO datapoints only)

The screenshot shows a yellow background with three settings. The first is 'Change of State Count:' followed by a text input field containing '0'. The second is 'Reset to:' followed by a text input field containing '0' and a green 'OK' button. The third is 'Time of State Count Reset:' followed by a text input field containing the placeholder '*/*/*, *:*:*'.

Change of State Count
 Displays the number of state changes

Reset To
 Here you can reset the state counter

Time of State Count Reset
 Shows the time of the last state counter reset

Runtime Counter (applies to BI and BO datapoints only)
 Here you can view the current runtime and reset the runtime counter to a specific time (e.g. in case of maintenance, change of pump).

Runtime (Active Time)
 Displays the active runtime of the device

Reset To
 Here you can reset the runtime counter. Enter the desired value and then click OK

Time of last Reset
 Shows the time of the last runtime counter reset

Status (All datapoint types)
 Here the status flag condition and the event state are displayed.

If checked, the status flags have the following meaning:

In Alarm
 Datapoint is in alarm. Cause can be faults, Off-normal conditions, and life-safety alarm.

Fault
 The datapoint or the physical input is not reliable, e.g. in case of sensor break (Open Loop).

Overridden
 Datapoint is in manual operation mode. Value has been overwritten.

Out of Service
 Physical input is decoupled from the datapoint, e.g. in case of manual override. The present value displayed is not the present value, which would be delivered by the physical input.

NOTE: Multiple flag indications are possible.

Example: A 'To-Fault transition' causes also always an alarm. Hence both, the 'In Alarm' and the 'Fault' status flags are enabled.

Event State (All datapoint types)
 Shows the event state of the datapoint:

- Normal Operation
Point is in normal operating state.
- Off-Normal Condition
Point value is out of normal range.
- Fault
Point is prevented from proper operation. Point value can be in normal or out of normal range. Due to the maloperation of the point, the value is unreliable.
Causes for a fault can be, for example sensor and cable breaks.
- Above High Limit
Point value has exceeded the high limit. Special case of the Off-Normal state of analog inputs and outputs.
- Below Low Limit
Point value has dropped below the low limit. Special case of the Off-Normal state of analog inputs and outputs.

Change of Value (applies to AI, AO, AV and PC datapoints only)

Increment

Here you can enter/change the change of value increment (COV). The COV Increment specifies the minimum change in present value that causes the controller sending the present value to the Eagle Web Interface.

Enter value into the field.

Period (applies to PC datapoint only)

Defines the amount of time in seconds between the periodic transmissions of the present value. This property can be used alone or in combination with the Increment property. When the period property is used in combination with the increment property, the present value will always be updated periodically independent on the transmissions of the present value due to the COV setting.

2. Click the SUBMIT button to save settings.
3. To view /edit datapoint command priorities, click on the *Command Priorities* tab (see "View / Edit Values" section).

View / Edit Command Priorities

(Applies to AO, AV, BO, BV, MO, and MV datapoint types only)

1. In the *Details* dialog box of the selected datapoint, select the *Command Priorities* tab.

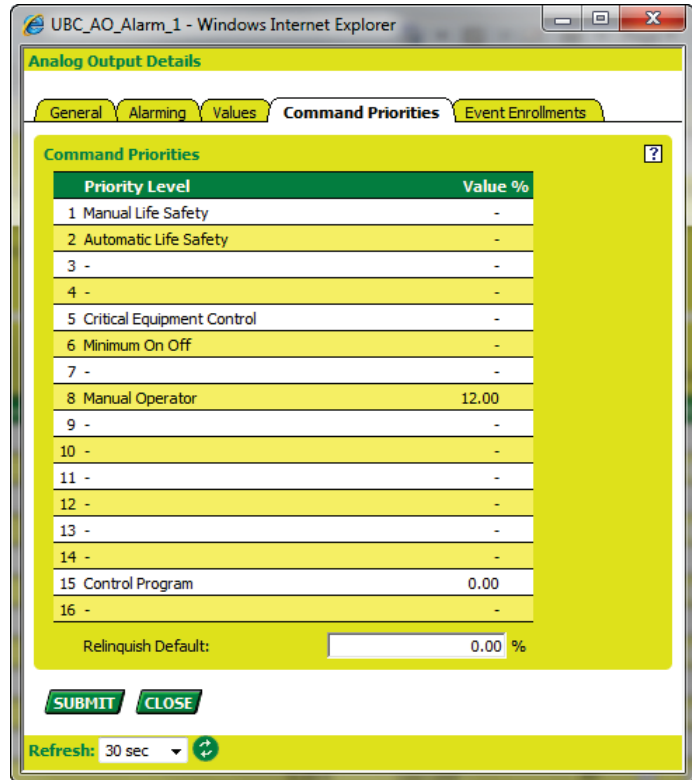

Here you can view the command priority levels and enter/change the relinquish default value.

The priority list has descending priority. The value on the highest priority level is written to the present value.

Relinquish Default

This value will be written to present value, if all values in the priority list are invalid.

Enter relinquish default value into the field.

3. To save changes, click the SUBMIT button.

For detailed description, please refer to the "Relinquish Default" and "Priority Level" sections.

View / Edit Event Enrollment Alarming

Event enrollment alarming can be used for observing the following datapoint properties:

- Present value
- Acknowledged transitions (datapoint alarms)
- Status flag conditions
- Elapsed active time / count limits

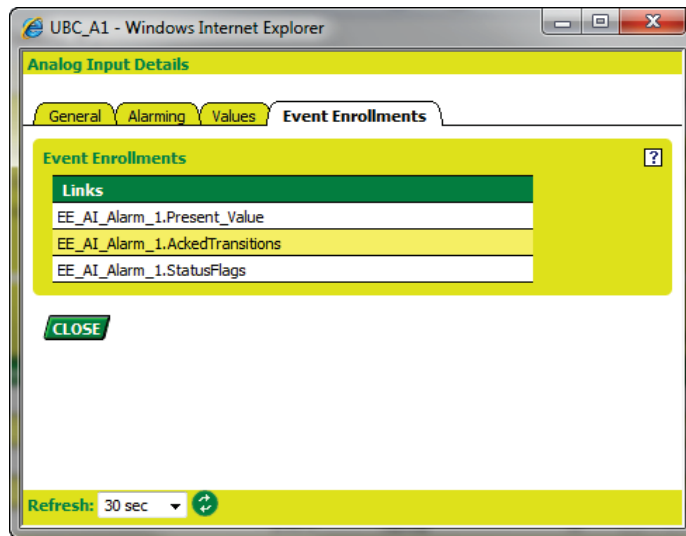

Present Value Observation

NOTE: The present value observation applies to all datapoint types.

Purpose Observe exceedings of the high and low limits of the datapoint.

Procedure 1. In the *Details* dialog box of the selected datapoint, select the *Event Enrollments* tab.

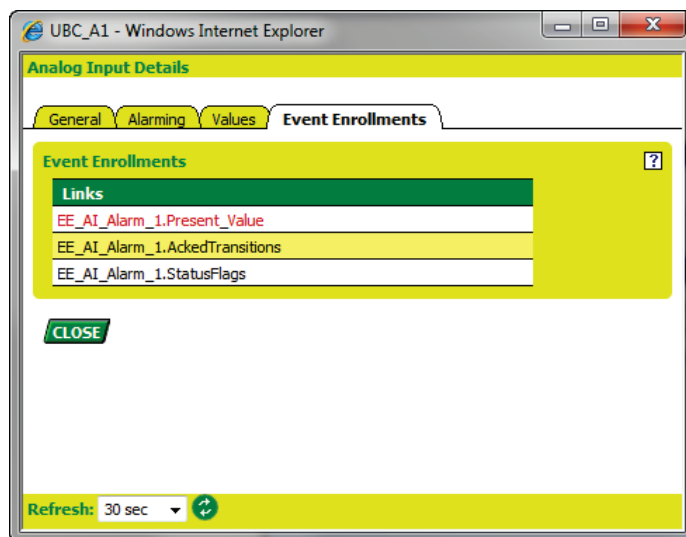

Here you can select different event enrollments for viewing and editing. Each event enrollment is displayed as link. By default, event enrollments have the following naming convention <EE = event enrollment> <datapoint type abbreviation> <event enrollment type>, for example EE ai. Present Value.

2. To view/edit an event enrollment, click the event enrollment, for example EE ai. Present Value. The *Details* dialog box for the selected event enrollment displays. The *Alarming* tab is selected by default.

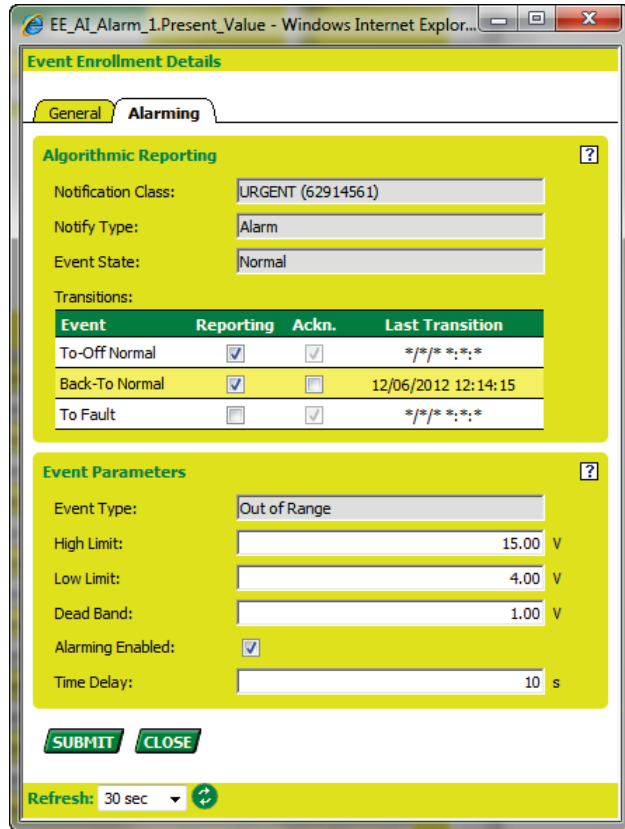

Algorithmic Reporting

Notification Class

Shows the name of the notification class. The value in brackets is the BACnet object ID of the notification class.

Notify Type

Shows the notify type. Defaults to 'event'. For details, see Notify Type property description

Event State

Shows the event state. For details, see Event State property description.

Transitions

Here the following data about transitions are shown:

Event

Shows the transition types that can be selected for reporting.

Reporting

Check the transition event(s) that should be observed and cause an event notification to the recipient (device or email addressee).

– **Back-To Normal**

An event notification is sent the recipient if the present value is within the high or low warning limits after the time delay has been expired.

– **To-Off Normal**

An event notification is sent the recipient if the present value exceeds or falls below the high or low warning limits within the time delay.

To Fault

This option has no function.

Ackn.

Shows the Acknowledged status and allows acknowledgement.

The acknowledged status (checked or unchecked), firstly depends on the **Ack Required** setting of the notification class in CARE. In CARE, for each transition type you can define whether an acknowledgement is required or

not. Secondly, the possibility to change the Ackn. status depends on the reporting status of the transition (enabled or disabled) here.

Last Transition

Shows the date when the last transition has occurred.

Event Parameters

Event Type

The event type is 'change of state'.

High Limit

Enter the high warning limit value.

Low Limit

Enter the low warning limit value.

NOTE:

The warning limits can be below or above the high and low limit reporting values.

Deadband

Enter a deadband value. This defines an additional trigger to set off an alarm. The event enrollment alarm is sent if the following condition is true: present value must, for at least the defined time delay (time), remain within the range: Low limit plus deadband and high limit minus deadband.

Suppress alarm

Check/uncheck this option if you want the alarming to be enabled/disabled.

Time delay

Enter a time delay in sec. The even enrollment alarm is sent if the present value still increases or decreases the warning limits after the time entered here has been elapsed.

For details on the options below, please refer to the datapoint descriptions in the CARE User Guide.

3. Click SUBMIT button, and/ or viewing general information of the event enrollment, click the *General* tab.

On the General the following information is displayed:

Properties

Object Type

Defaults to event enrollment for all point types.

Description

Shows the prefix of the event enrollment name as entered in CARE.

Access Rights

Shows the read and write access level of the event enrollment.

To write values to a datapoint, you must have a write access level equal or higher than the write access level of the event enrollment.

Datapoint details will only be displayed if you have a read access level equal to or higher than the read access level of the event enrollment.

4. Click SUBMIT button to save settings, and then click CLOSE button.

Acknowledged Transitions Observation

NOTE: The acknowledged transitions observation applies to all datapoint types.

Purpose

Allows observing the acknowledgement behavior of a user for To-Off-Normal and To-Fault transition events of the datapoint. CARE checks whether a transition event has been acknowledged or not. If a transition event has not been acknowledged within a definable delay time, an alarm based on an event enrollment (event enrollment alarm) is sent to a supervisory recipient, for example BACnet client.

- Procedure**
1. In the *Details* dialog box of the selected datapoint, select the *Event Enrollments* tab.

Here you can select different event enrollments for viewing and editing. Each event enrollment is displayed as link. By default, event enrollments have the following naming convention <EE = event enrollment> <datapoint type abbreviation> <event enrollment type>, for example EE ai. AckedTransitions.

2. To view/edit an event enrollment, click the event enrollment, for example EE ai. AckedTransitions. The *Details* dialog box for the selected event enrollment displays. The *Alarming* tab is selected by default.

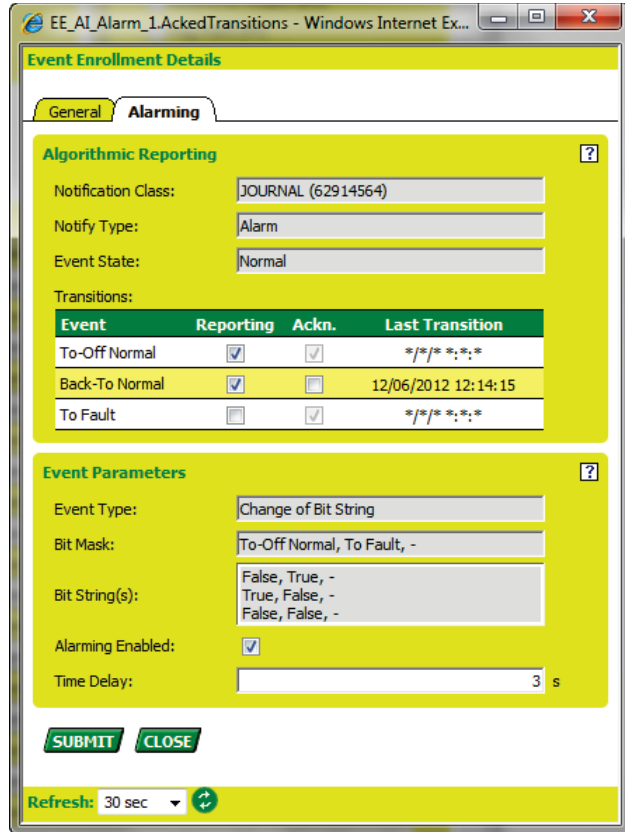

Algorithmic Reporting

Notification Class

Shows the name of the notification class. The value in brackets is the BACnet object ID of the notification class.

Notify Type

Shows the notify type. Defaults to 'event'. For details, see Notify Type property description

Event State

Shows the event state. For details, see Event State property description.

Transitions

Here the following data about transitions are shown:

Event

Shows the transition types that can be selected for reporting.

Reporting

Check the transition event(s) that should be observed and cause an event notification to the recipient (device or email addressee).

- Back-To Normal

An event notification is sent if the acknowledgement is sent after the time delay has been expired.

- To-Off Normal
An event notification is sent if the acknowledgement is missing within the time delay
- To Fault
This option has no function.

Ackn.
Shows the Acknowledged status and allows acknowledgement.
The acknowledged status (checked or unchecked), firstly depends on the **Ack Required** setting of the notification class in CARE. In CARE, for each transition type you can define whether an acknowledgement is required or not. Secondly, the possibility to change the Ackn. status depends on the reporting status of the transition (enabled or disabled) here.

Last Transition
Shows the date when the last transition has occurred.

Event Parameters

- Event Type**
The event type is 'change of bitstring'.
 - Bit Mask**
Shows the transition event(s) that are checked for acknowledgement.
 - Bit String(s)**
Shows the possible logical values (true, false, CARE verifies with negative logic for the false condition) resulting from the comparison of the selected transition event(s) and the underlying bit string mask. An event enrollment alarm will be sent, if the transition event will **not** be acknowledged within the delay time.
 - Suppress alarm**
Check/uncheck this option if you want the alarming to be enabled/disabled.
 - Time delay**
Enter a time delay in sec. The event enrollment alarm will be sent if the transition event has **not** been acknowledged within the delay time.
- For details on the options below, please refer to the datapoint descriptions in the CARE User Guide.

3. Click SUBMIT button, and/ or viewing general information of the event enrollment, click the *General* tab.

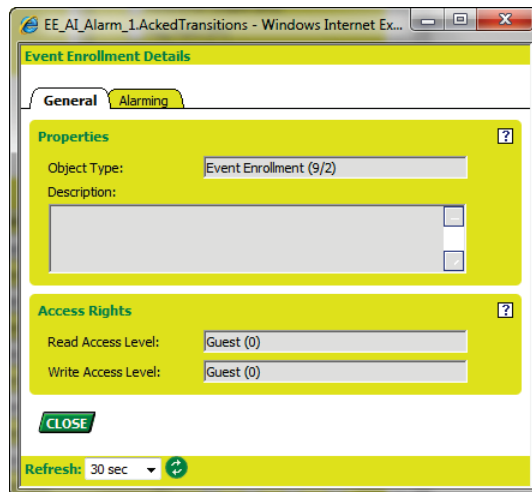

On the General the following information is displayed:

Properties

Object Type
Defaults to event enrollment for all point types.

Description

Shows the prefix of the event enrollment name as entered in CARE.

Access Rights

Shows the read and write access level of the event enrollment.

To write values to an event enrollment, you must have a write access level equal or higher than the write access level of the event enrollment.

Event enrollment details will only be displayed if you have a read access level equal to or higher than the read access level of the event enrollment.

4. Click SUBMIT button to save settings, and then click CLOSE button.

Status Flag Condition Observation

NOTE: The status flag condition observation applies to all datapoint types.

Purpose

Observe status flags conditions.

Procedure

1. In the *Details* dialog box of the selected datapoint, select the *Event Enrollments* tab.

Here you can select different event enrollments for viewing and editing. Each event enrollment is displayed as link. By default, event enrollments have the following naming convention <EE = event enrollment> <datapoint type abbreviation> <event enrollment type>, for example EE ai. StatusFlags.

2. To view/edit an event enrollment, click the event enrollment, for example EE ai. StatusFlags. The *Details* dialog box for the selected event enrollment displays. The *Alarming* tab is selected by default.

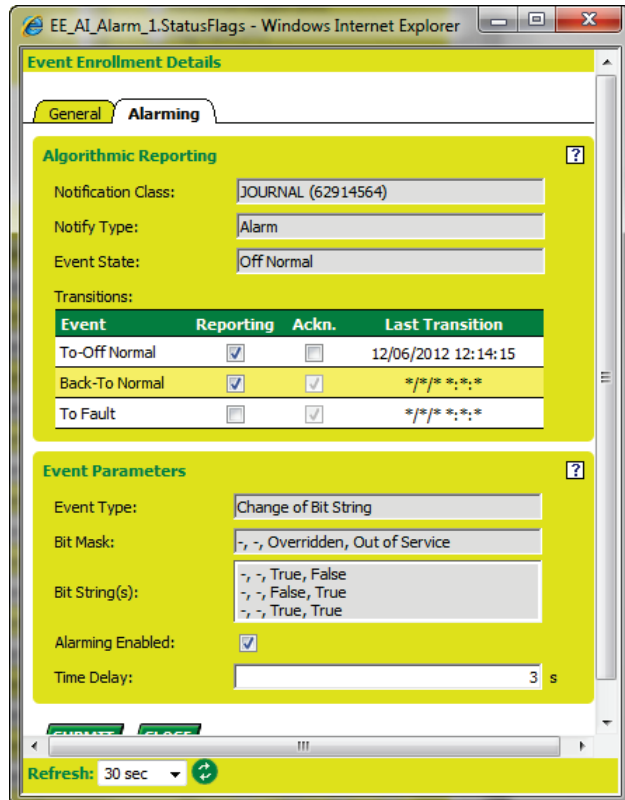

Algorithmic Reporting

Notification Class

Shows the name of the notification class. The value in brackets is the BACnet object ID of the notification class.

Notify Type

Shows the notify type. Defaults to 'event'. For details, see Notify Type property description

Event State

Shows the event state. For details, see Event State property description.

Transitions

Here the following data about transitions are shown:

Event

Shows the transition types that can be selected for reporting.

Reporting

Check the transition event(s) that should be observed and cause an event notification to the recipient (device or email addressee).

- Back-To Normal
An event notification is sent to the recipient if a status flag is disabled after the time delay has been expired.
- To-Off Normal
An event notification is sent to the recipient if a status flag is enabled within the time delay.

To Fault

This option has no function.

Ackn.

Shows the Acknowledged status and allows acknowledgement.

The acknowledged status (checked or unchecked), firstly depends on the **Ack Required** setting of the notification class in CARE. In CARE, for each transition type you can define whether an acknowledgement is required or not. Secondly, the possibility to change the Ackn. status depends on the reporting status of the transition (enabled or disabled) here.

Last Transition

Shows the date when the last transition has occurred.

Event Parameters

Event Type

The event type is 'change of bitstring'.

Bit Mask

Shows the status flags that are observed.

Bit String(s)

Shows the possible logical values (true, false) resulting from the comparison of the selected status flags and the underlying bit string mask.

Suppress alarm

Check/uncheck this option if you want the alarming to be enabled/disabled.

Time Delay

Enter a time delay in sec. An event enrollment alarm will be sent for each status flag that is enabled (checked) within the time delay time.

For details on the options below, please refer to the datapoint descriptions in the CARE User Guide.

3. Click SUBMIT button, and/ or viewing general information of the event enrollment, click the *General* tab.

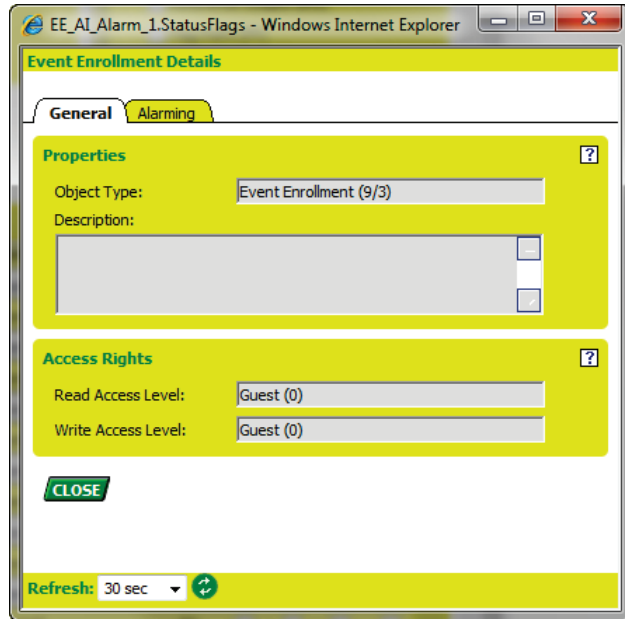

On the General the following information is displayed:

Properties

Object Type

Defaults to event enrollment for all point types.

Description

Shows the prefix of the event enrollment name as entered in CARE.

Access Rights

Shows the read and write access level of the event enrollment.

To write values to a datapoint, you must have a write access level equal or higher than the write access level of the event enrollment.

Datapoint details will only be displayed if you have a read access level equal to or higher than the read access level of the event enrollment.

4. Click SUBMIT button to save settings, and then click CLOSE button.

Elapsed Active Time / Count Limits Observation

NOTE: The elapsed runtime and count limits observation applies to the following datapoint types: BI, BO, and BV.

Purpose Allows observing the state of the elapsed runtime or the count limits.

Procedure 1. In the *Details* dialog box of the selected datapoint, select the *Event Enrollments* tab.

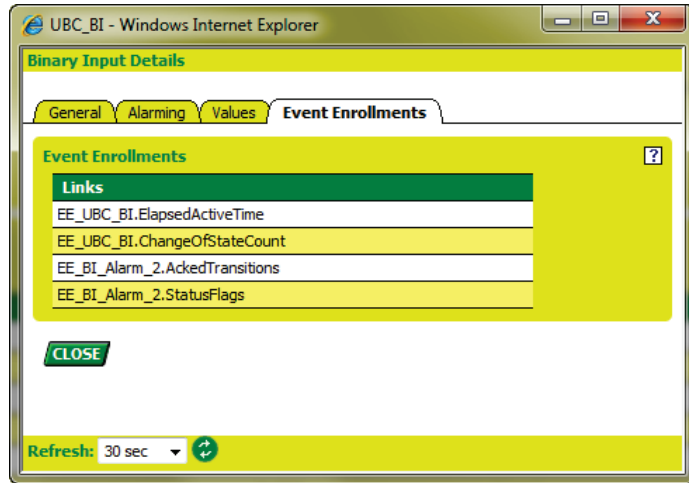

Here you can select different event enrollments for viewing and editing. Each event enrollment is displayed as link. By default, event enrollments have the following naming convention <EE = event enrollment> <datapoint type abbreviation> <event enrollment type>, for example EE ai. ElapsedActiveTime.

- To view/edit an event enrollment, click the event enrollment, for example EE ai. ElapsedActiveTime. The *Details* dialog box for the selected event enrollment displays. The *Alarming* tab is selected by default.

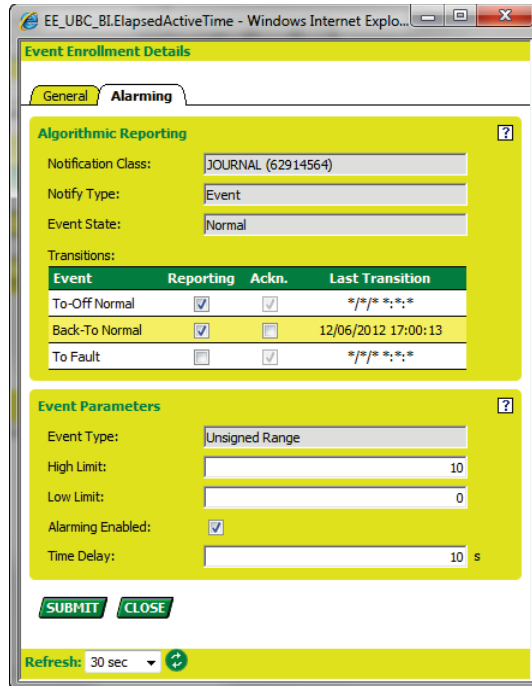

Algorithmic Reporting

Notification Class

Shows the name of the notification class. The value in brackets is the BACnet object ID of the notification class.

Notify Type

Shows the notify type. Defaults to 'event'. For details, see Notify Type property description

Event State

Shows the event state. For details, see Event State property description.

Transitions

Here the following data about transitions are shown:

Event

Shows the transition types that can be selected for reporting.

Reporting

Check the transition event(s) that should be observed and cause an event notification to the recipient (device or email addressee).

– **Back-To Normal**

An event notification is sent if the elapsed active (elapsed) runtime, respectively number of state count changes takes a value within the high or low limit after the time delay has been expired.

– **To-Off Normal**

An event notification is sent if the elapsed active (elapsed) runtime value, respectively number of state count changes value exceeds the high or low limit within the alarm.

To Fault

This option has no function.

Ackn.

Shows the Acknowledged status and allows acknowledgement.

The acknowledged status (checked or unchecked), firstly depends on the **Ack Required** setting of the notification class in CARE. In CARE, for each transition type you can define whether an acknowledgement is required or not. Secondly, the possibility to change the Ackn. status depends on the reporting status of the transition (enabled or disabled) here.

Last Transition

Shows the date when the last transition has occurred.

Event Parameters**Event Type**

The event type is 'unsigned range'.

High Limit

Enter the high limit value for the elapsed active (elapsed) runtime, respectively the number of state count changes.

Low Limit

Enter the low limit value for the elapsed active (elapsed) runtime respectively the number of state count changes.

Suppress alarm

Check/uncheck this option if you want the alarming to be enabled/disabled.

Time delay

Enter a time delay in sec. An event enrollment alarm will be sent if the elapsed active (elapsed) runtime, respectively the number of state count changes increases the high or low limit within the time delay time.

For details on the options below, please refer to the datapoint descriptions in the CARE User Guide.

3. Click SUBMIT button, and/ or viewing general information of the event enrollment, click the *General* tab.

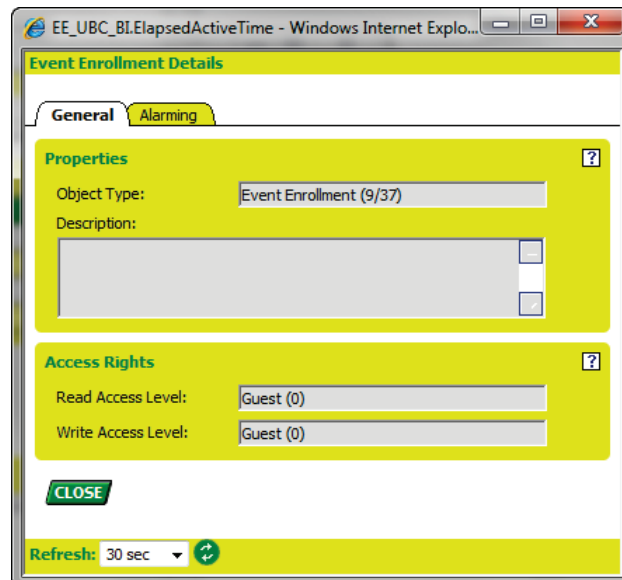

On the General the following information is displayed:

Properties

Object Type

Defaults to event enrollment for all point types.

Description

Shows the prefix of the event enrollment name as entered in CARE.

Access Rights

Shows the read and write access level of the event enrollment.

To write values to a datapoint, you must have a write access level equal or higher than the write access level of the event enrollment.

Datapoint details will only be displayed if you have a read access level equal to or higher than the read access level of the event enrollment.

4. Click SUBMIT button to save settings, and then click CLOSE button.

System Settings

System settings include the following settings:

- System date, time and time zone
- Cycle time category (see also "Cycle Time Category" section).
- Communication settings which include:
 - Interface settings for Ethernet, LON, and Web-Server, such as IP address, neuron chip ID, automatic logout time of web server
 - User name and password definition

View/Change Clock Settings

- Procedure**
1. In the tree, expand the *Advanced* item, then the *System Settings* item and click on Clock.

RESULT: On the *Date & Time* tab on the right, the following clock values are displayed and can be changed:

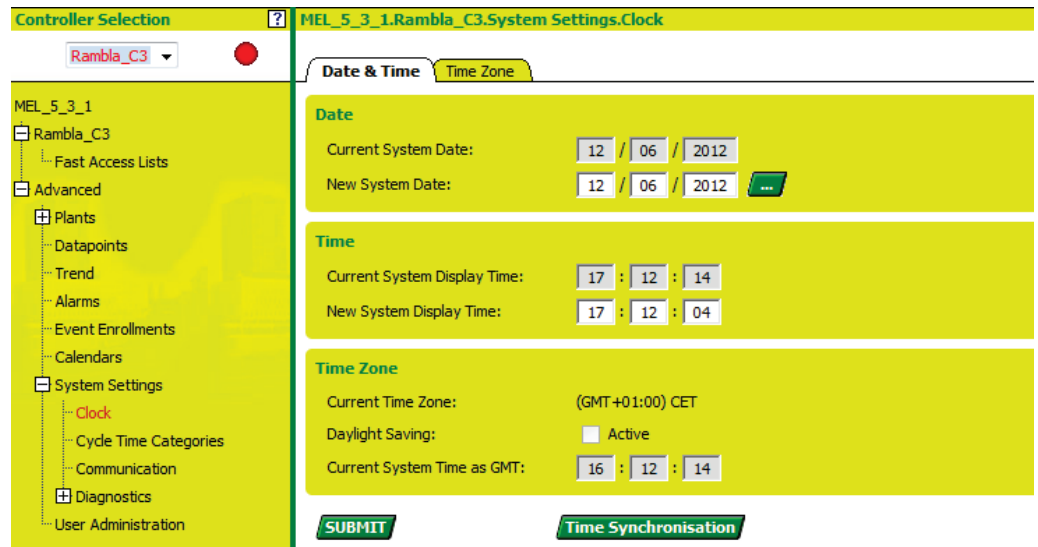

Date
Displays current system date.

Time
Displays current system date.

Time Zone
Displays the current time zone.

2. To change the system date, enter the new system date in the **New System Date** fields, or click **BROWSE** button and select date in the calendar.
3. To change the system time, enter the new system time in the **New System Display Time** fields.
4. To synchronize all devices on the bus with the local time of the current controller, click **Time Synchronisation** button. This sets all devices on the bus supporting time sync to the current System Display Time of the selected controller.
5. To change the time zone, click on the *Time Zone* Tab.

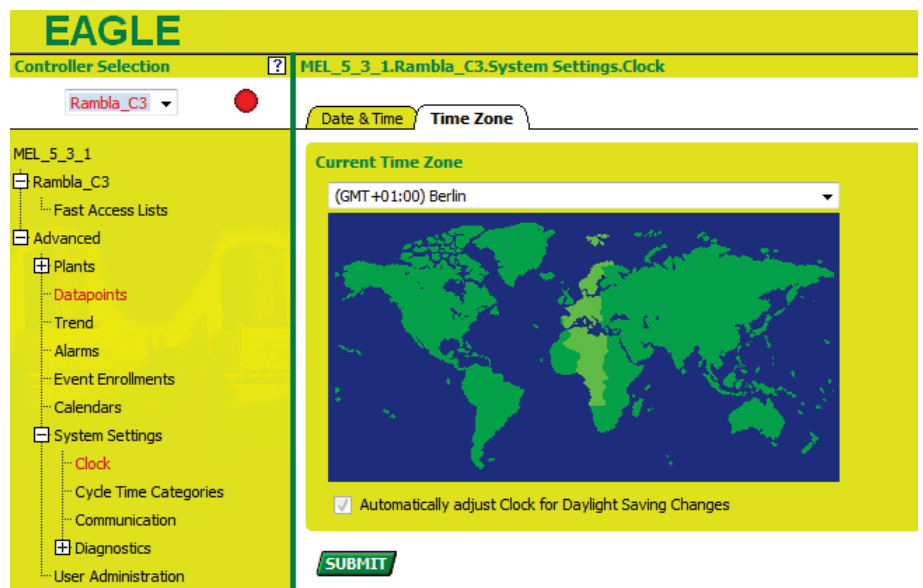

6. Select another time zone from the **Current Time Zone** drop-down list box,

7. Check the **Automatically adjust Clock for Daylight Saving Changes** option.

8. To save changes, click the SUBMIT button.

NOTE: You can only change clock and time zone settings if your access level is equal to or higher than the access level defined for this action in the User Administration.

View/Change Cycle Time Categories

The cycle time category defines the (target) time in ms after a control loop is restarted automatically.

Target cycle times are grouped in the following categories with descending priority:

- Very Fast.
- Fast
- Medium
- Slow

In other words, a control loop which has the very fast category assigned, is executed more often in the same time.

Each control loop is assigned to one of these categories. Any changes done to the target cycle time will affect all control loops assigned to the corresponding category.

The controller executes multiple control loops simultaneously (multitasking). There is a dynamic relation between the target cycle time categories as shown in the following diagram:

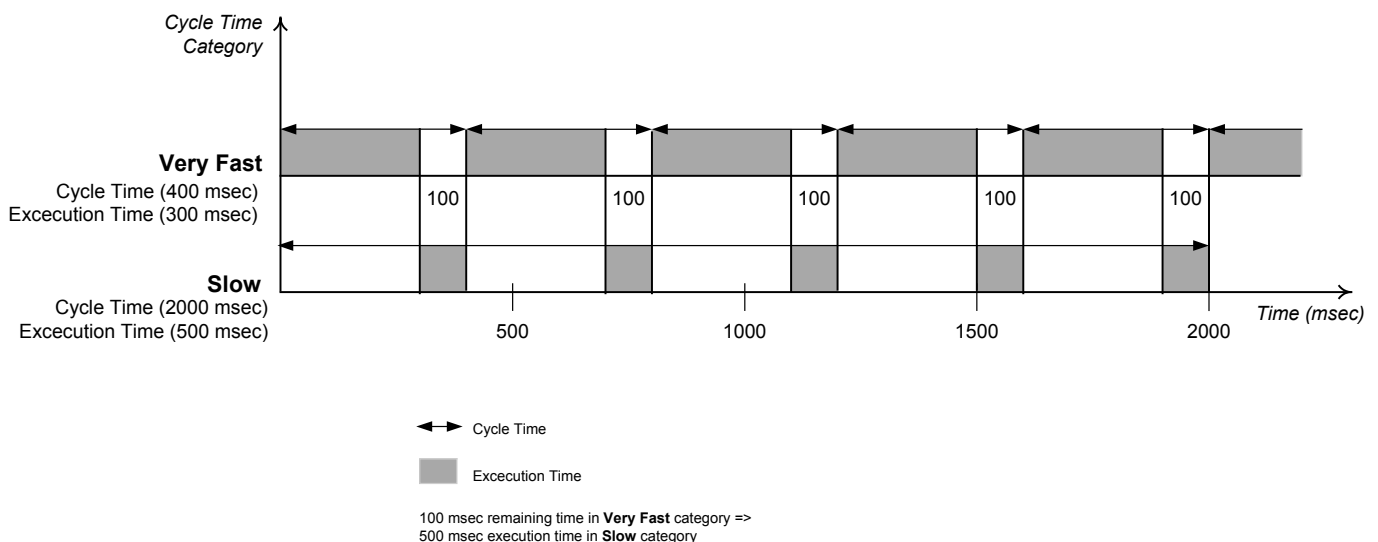

The diagram illustrates, that the degree of execution of a control loop having a slow cycle time category assigned, depends on the remaining time (=cycle time minus execution time) provided by a control loop executed in very fast cycle time.

The target cycle time should not be exceeded during control loop execution. If a category's execution time is permanently greater than the corresponding target cycle time, the controller is overloaded and the target cycle time should be changed by increasing it to higher values than the execution time.

IMPORTANT

It is recommended to set the cycle times to values to between 30 % and 50 % higher than the execution times in order to make sure that control loops having medium and slow cycle times assigned can be executed in appropriate time.

NOTE: The settings done in the Eagle Web Interface will be overwritten after a download with CARE. Hence, upload the application into CARE using Excel Online after the plant has been setup.

Procedure

1. In the tree, expand the *Advanced* item, then the *System Settings* item and click on **Cycle Time Categories**.

RESULT: On the *Cycle Times Categories* tab on the right, the following is displayed:

- **Category**
The cycle time category defines the time in ms after a control loop is restarted automatically (values see *Target Cycle Time* column).
- **Target Cycle Time (ms)**
Target cycle times are grouped in the following categories: Slow, Medium, Fast, and Very Fast.
- **Actual Execution Time (ms)**
The actual execution time is displayed for comparison in the *Actual Cycle Time* column.

2. To change the target cycle time, enter the value for the category in the *Target Cycle Time (in ms)* column. Note that the minimum cycle time in ms can only be increased but not decreased.

3. To save changes, click the SUBMIT button.

NOTE: Cycle time categories are only displayed and changeable if your access level is equal to or higher than the access level defined for these actions under User Administration.

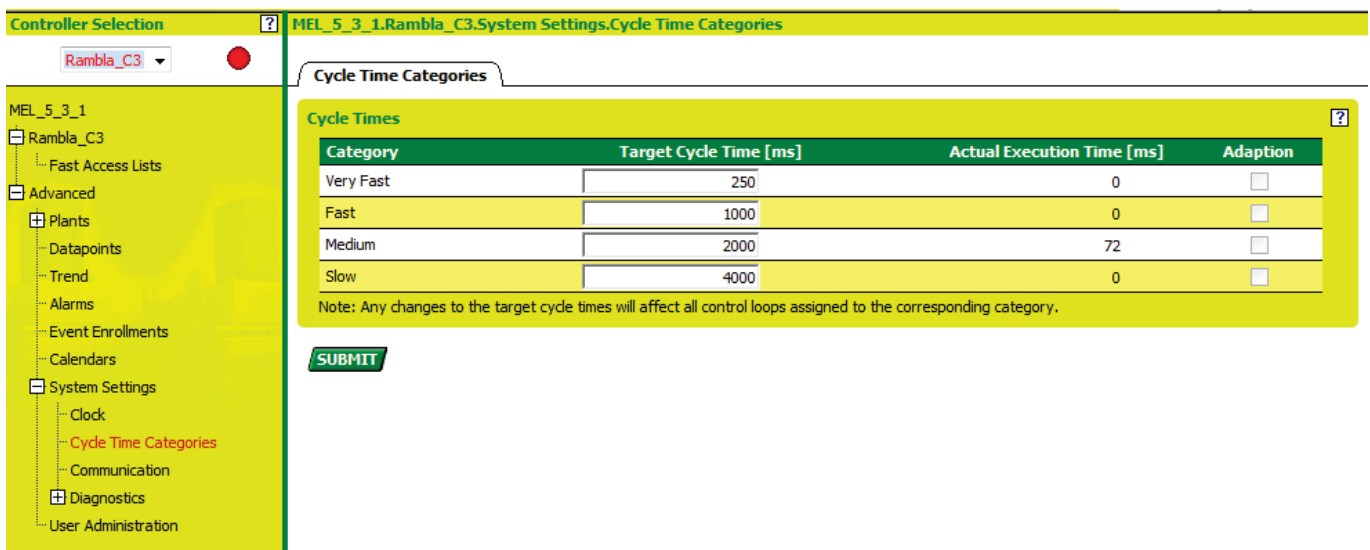

View/Change Communication Settings

Communication settings include:

- Interface settings for Ethernet, LON, and Web-Server, such as IP address, neuron chip ID, automatic logout time of web server
- User name and password definition
- E-Mail Alarming

Procedure

1. In the tree, expand the *Advanced* item, then the *System Settings* item and click on Communication.

RESULT: On the *Interface Settings* tab you can view the Ethernet and LON bus settings in the areas of the same name. In addition, you can set the logout time of the web server (controller).

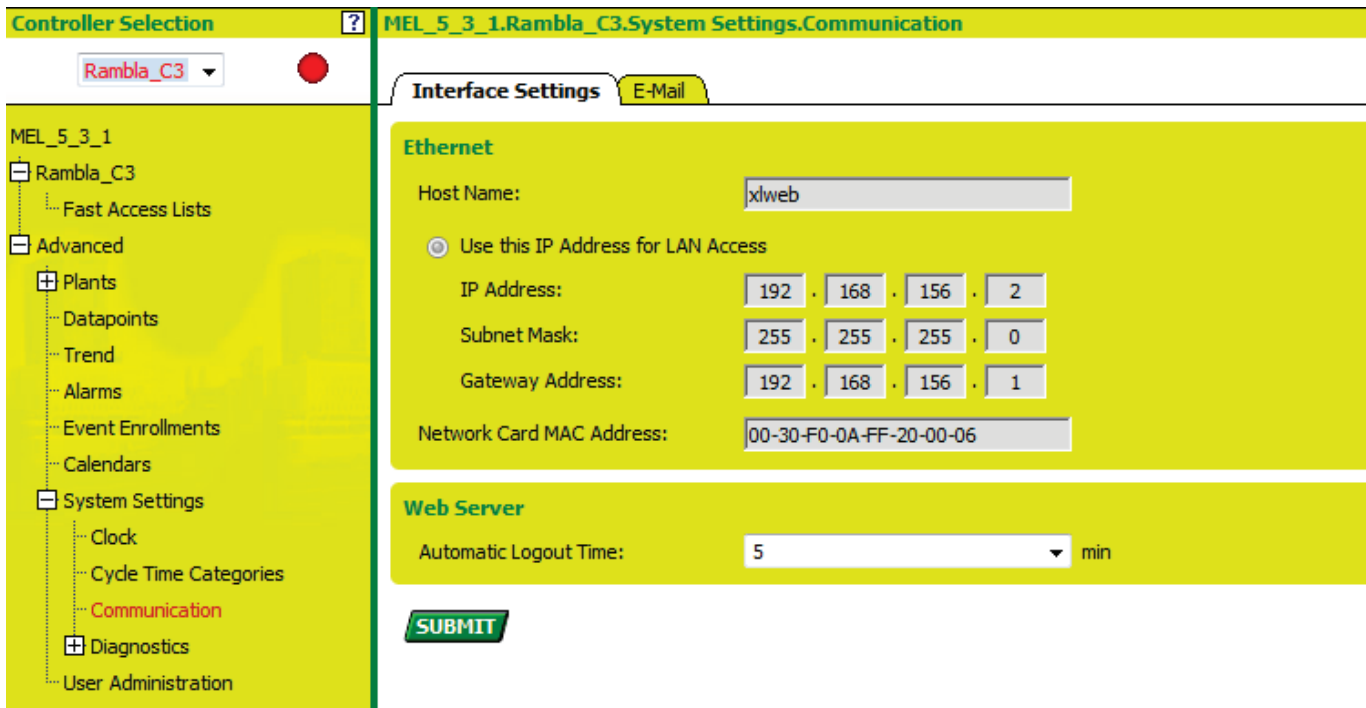

- From the **Serial Port** drop-down list boxes, select the baudrates.

The following properties are shown:

Host Name

Displays the name of the host (server).

Ethernet

Use this IP address for LAN Access

The IP address has been explicitly allocated in CARE.

- IP address
- Subnet mask
- Gateway address

IP address for direct connection (through crossover cable)

Network Card MAC Address

- From Automatic Logout Time, select the time for logout of the web server. To deactivate logout, enter 0. The automatic logout time is the time of inactivity after you are automatically logged out and be redirected to the Login dialog.

NOTES: The automatic logout time applies to the controller, not to the user.

This means, that the current time set for the controller applies to all users which are currently logged in and access the controller.

If 'No automatic Logout' is selected, you will be still logged in even if the web browser has been closed.

- To save changes, click the SUBMIT button.

NOTE: You can only change communication settings if your access level is equal to or higher than the access level defined for this action in the User Administration.

- To view/change E-Mail settings, click on the *E-Mail* tab.

MEL_5_3_1.Rambla_C3.System Settings.Communication

Interface Settings E-Mail

Common Settings ?

DNS Server 1:

DNS Server 2:

SMTP Server:

E-Mail Address (Sender):

E-Mail Mode:

E-Mail Subject Prefix String:

E-Mail Send Repeat Time: min Off:

E-Mail Alarming Enabled:

SUBMIT

Test E-Mail ?

Recipient:

Subject: **SEND**

E-Mail Status: TimeStamp:

Common Settings

Here the e-mail alarming settings as entered in CARE are displayed.

DNS-Server1 IP Address

Shows the IP address of DNS server1.

DNS-Server2 IP Address

Shows the IP address of DNS server2.

SMTP Server

Shows the name or the IP address of the SMTP server.

E-Mail Address (Sender)

Shows the email address of the sender.

E-Mail Mode

Shows one of the following email modes:

- None
Alarm emails are sent directly to the SMTP server of the DSL provider of the recipient. The Eagle can be accessed via port forwarding or VPN.
- Relay
A relay server as the first SMTP server receives the email from the Eagle and sends it to a second SMTP server of the recipient. The relay server can reside in a customer network or at a DSL provider. The Eagle can be accessed via port forwarding or VPN.

E-Mail Subject Prefix String

Shows the default prefix of the email subject name. Default is 'Alarm'.

E-Mail Send Repeat time

You can enable/disable and change the E-Mail Send Repeat time and enable/disable the email alarming as described in steps 17 through 22 of the "E-Mail Alarming" section.

Test E-Mail

Here you can perform an email test as described in steps 17 through 22 of the "E-Mail Alarming" section.

9. Click the SUBMIT button to save settings on the *Interface Settings* and *E-Mail* tabs.

View LON Diagnostic Data

- Procedure**
1. In the tree, expand the *Advanced* item, the *System Settings* item and then the *Diagnostics* item.
 2. Click on LON Statistics.

RESULT: The *Statistics* tab displays. Here you can select LON statistic properties for trending. The **Active Trending** checkbox shows whether trending is active or not. For each property its current value is displayed.

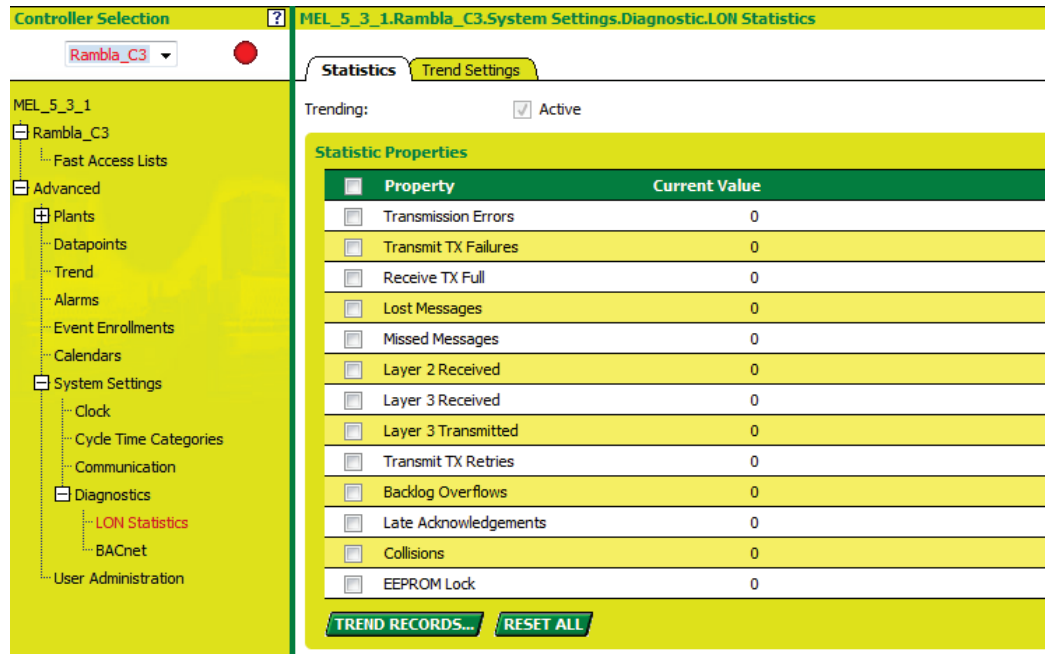

3. To display information of the property, click on the property in the list.
4. To reset all property values, click the RESET ALL button. Note that single properties cannot be reset.
5. To display trend records, check the properties you want to trend and click the TREND RECORDS button.

RESULT: The *Trend Records* dialog box displays. Here you can display trended LON statistic properties for a defined time range. Note that the complete time range for trending is defined on the *Settings* tab.



6. To define the time range, for which the trended records should be shown, do the following:
 - i. Click the **From Date** checkbox and enter the start date into the fields or select date by clicking the BROWSE button.
 - j. In the **Time** fields enter the time.

NOTE:

If the checkbox is unchecked, the fields are disabled. This means that trended records will be shown on any date up to and including the end date.

k. Click the **To Date** checkbox and enter the end date into the fields or select date by clicking the BROWSE button.

l. In the **Time** fields enter the time.

NOTE:

If the checkbox is unchecked, the fields are disabled. This means that trended records will be shown on any date from the start date on.

NOTE:

If both fields are disabled, trended records will be shown instantly and all the time.

m. To display trend records for the defined time range, click the GO button.

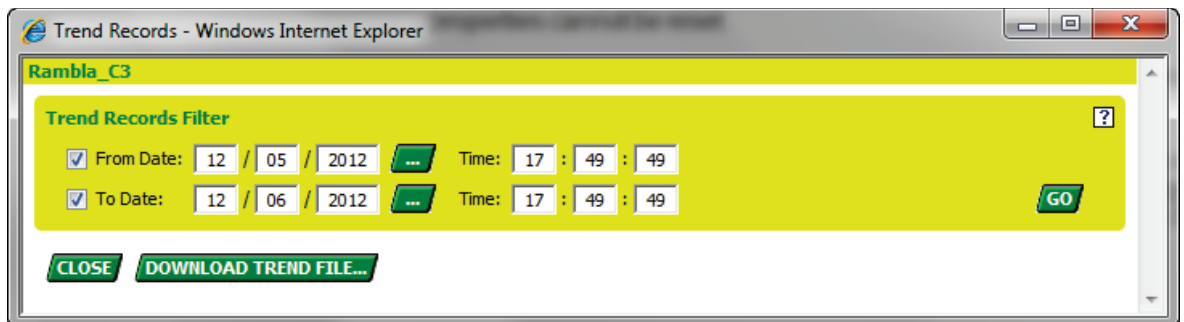

RESULT: Under **Trend Records**, the found trend records will be listed. The statistic properties are listed columnwise.

For each property its value and timestamp when the property was recorded, are displayed. The records can be saved into a file.

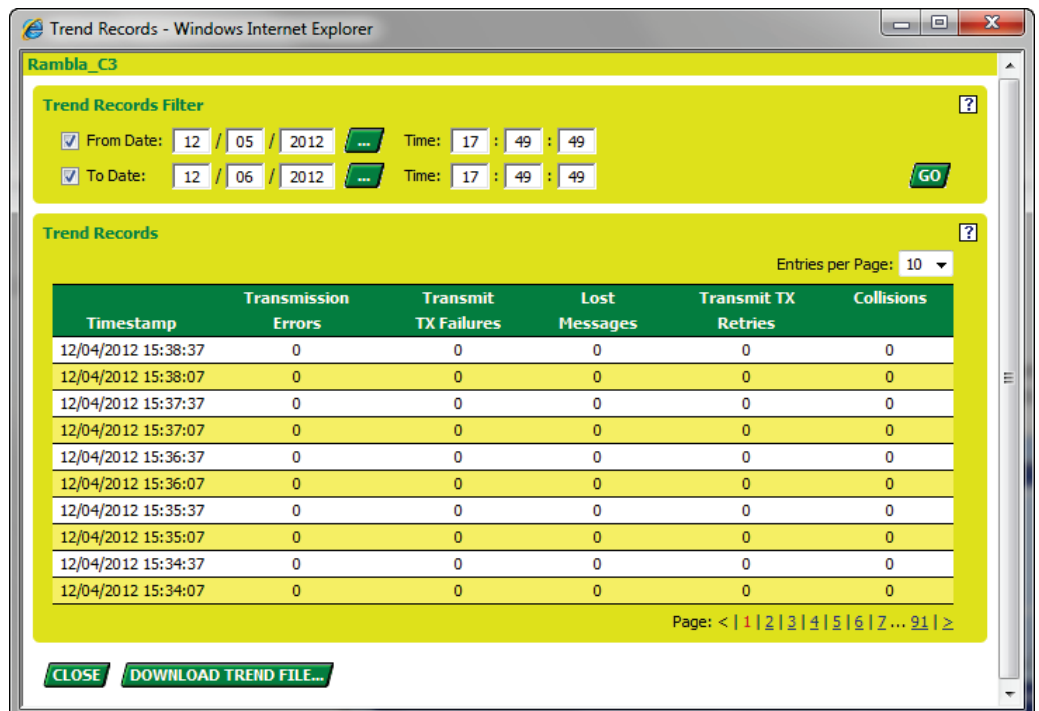

7. To save the records, click the DOWNLOAD TREND FILE button and save the file to the desired location.

See Buffer Size Note.

- To define trend settings, click on the *Trend Settings* tab. For further instructions on trending, please refer to the "Trend" chapter.

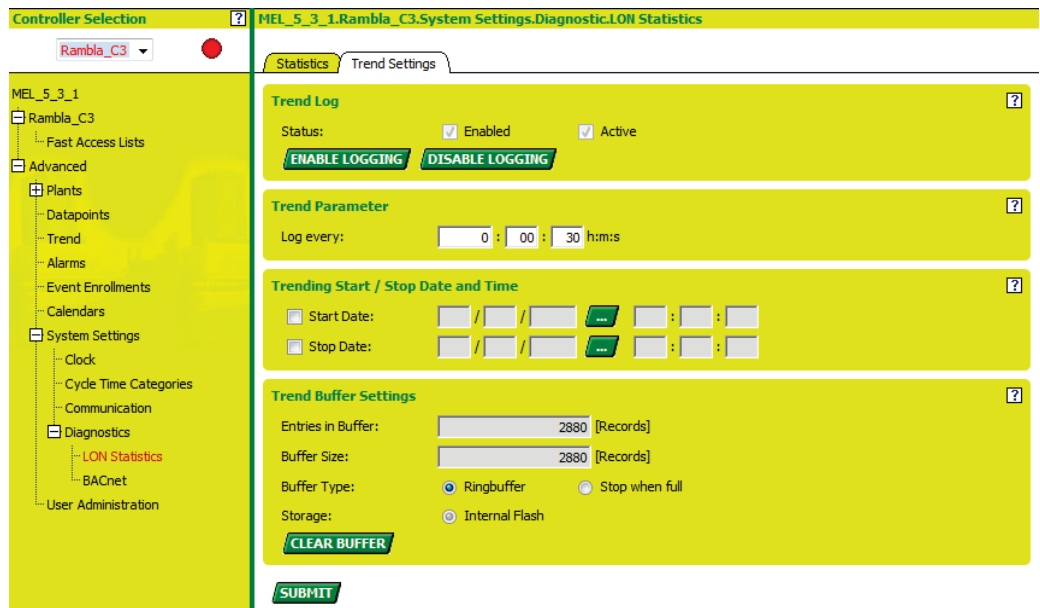

View BACnet Diagnostic Data

- Procedure**
- In the tree, expand the *Advanced* item, the *System Settings* item and then the *Diagnostics* item.
 - Click on *BACnet*.
 - Click *Statistics* tab on the right pane.

RESULT: The BACnet statistics for Services, MS/TP and Miscellaneous are shown. The properties show the communication status and indicate communication problems.

In the **Initiated** column, the number of items performed by the Eagle (server) is listed. In the **Executed** column, the number of items generated by BACnet clients or other Eagle controllers are listed.

Statistics

Service Name	Initiated	Executed
i-am	5	7
read-prop	24	0
unconf-private-transfer	42	42
who-is	2	0
Ø COV Notifications per Minute	0	0

MS/TP Statistics

-- No Entry --

Miscellaneous

BACnet device ID	3
BACnet/IP network	1
max. APDU length / max. segments	1476 / 16
APDU timeout / segm. timeout	3000 / 2000
APDU retries	4
num. of COV subscr.	0

View Panel Bus Diagnostic Data

Procedure

1. In the tree, expand the *Advanced* item, the *System Settings* item and then the *Diagnostics* item.
2. Click on *Panel Bus*.
3. Click *Statistics* tab on the right pane.

RESULT: The Module List of the Panel bus is shown with the following properties for each module:

- Type
- Technical address
- Status (online, offline)
- Software version
- Terminal States (0 = no failure, 1 = failure, etc. open/shortcut of NTC sensor)

Module List

Type	Address	Status	SW Version	Terminal Status
XF(R)S24, 6xDO	1	Online	1.01.04	000000
XF(R)S24, 6xDO	2	Offline	-	-
XF821, 8xAI	1	Online	1.01.05	00000000
XF821, 8xAI	2	Offline	-	-
XF(R)S22, 8xAO	1	Online	1.01.05	00000000
XF(R)S22, 8xAO	2	Offline	-	-
XF830, 12xDI, 8xAI, 8xAO, 6xDO	1	Online	1.00.02	00000000000000000000000000000000
XF830, 12xDI, 8xAI, 8xAO, 6xDO	2	Offline	-	-

SendOnDelta for Analog Inputs

Beginning with firmware 3-04-02-07, the following fixed SendOnDelta has been implemented for analog inputs:

- 0.5% for AI types:
 - 0...10V / 0...20mA
 - 0...10V / 0...20mA with pull-up
 - 2...10V / 4...20mA

- 0.1K for AI types: NTC20K, NTC 10K
PT1000_1, PT1000_2
PT3000
NI1000_TK500009
BALCO

This was done in order to reduce the number of value updates, which could cause too high cycle times for high point count applications (> 500 IOs), and which could cause false fault alarms for Analog Inputs.

Adjustable Scan Cycle Time

Beginning with firmware 3-04-02-07, the scan cycle time per Panel-bus can be adjusted in as follows:

- fastest scan cycle time that can be set is 70 msec
- with CARE 10.05 the scan cycle time needs to be set after every application download
- upload into CARE is possible in CARE 10.06

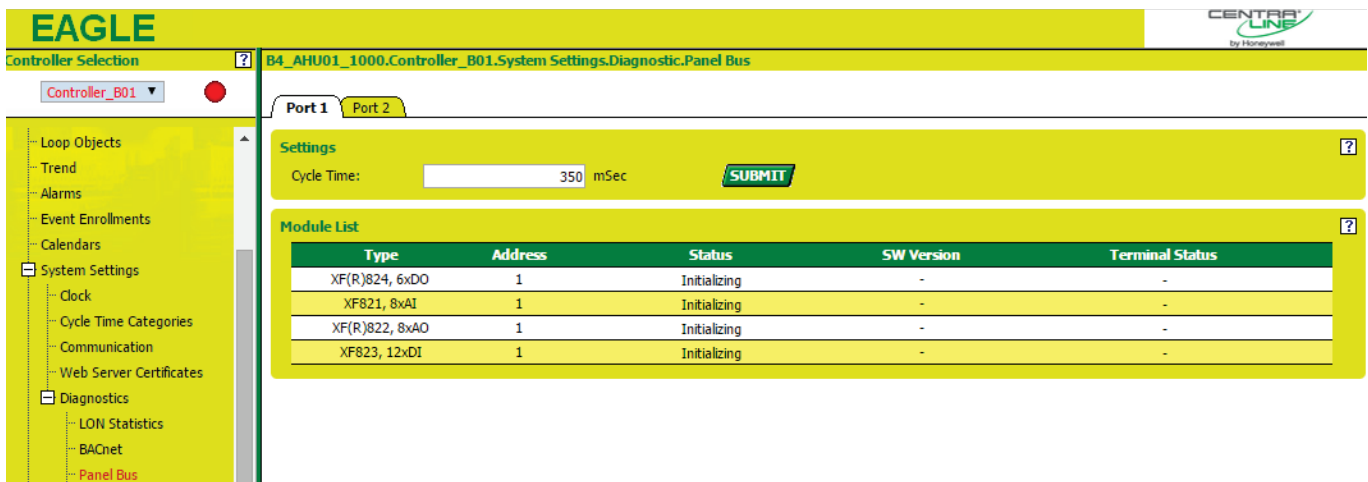

View BACnet Diagnostic Data

Search Using "Who Has"

- Purpose** The 'Who Has' function allows searching for BACnet objects and BACnet object identifiers (IDs).
- Procedure**
1. In the tree, expand the *Advanced* item, the *System Settings* item and then the *Diagnostics* item.
 2. Click on BACnet, and then on the *Who Has?* tab.

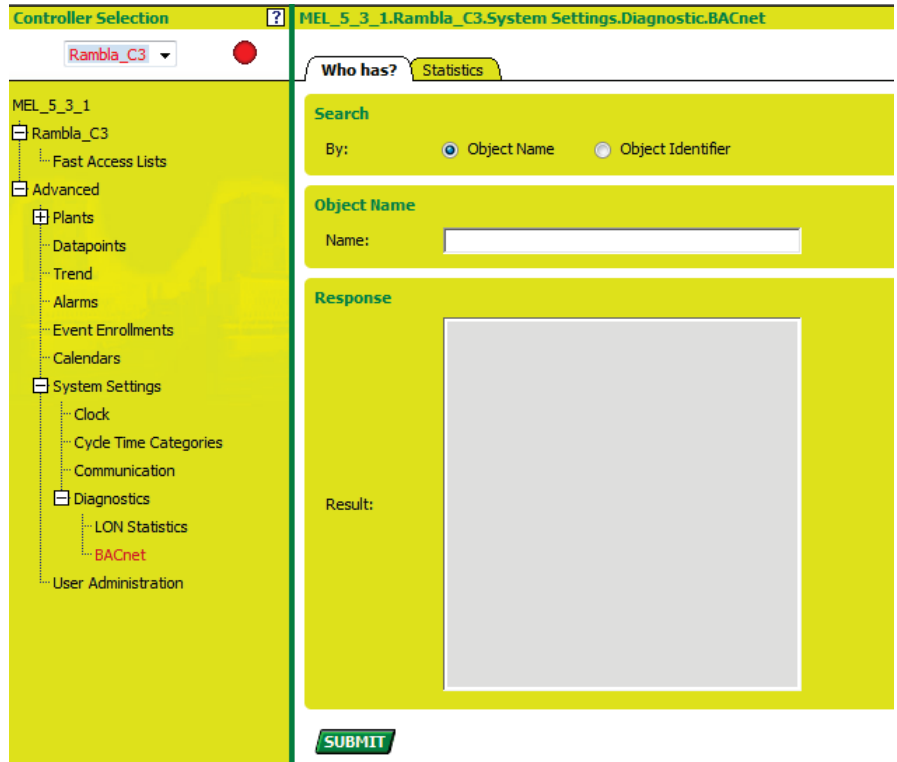

3. Select corresponding radio button, **Object Name** or **Object Identifier** to define the search option.
4. If you search for object names, enter the search name in the **Name** field.
5. If you search for object identifiers, enter the identifier in the **Number** field.
6. Click SUBMIT.

RESULT: In the **Result** list, the findings are shown.

BACnet Statistics

Purpose The BACnet statistics function can show the following BACnet statistics data:

- service statistics
- MS/TP statistics
- miscellaneous statistics

In addition, you can enable or disable IP-MSTP broadcast routing. Broadcast messages are "Who is", "I am", "Who has", "I have", and synchronizations between controllers.

Disabling IP-MSTP broadcast routing can reduce the network traffic on the BACnet MSTP network in order to optimize the pure MSTP communication speed.

Note that disabling IP-MSTP broadcast routing has the following side-effects:

- BACnet front-ends like EBI will no more be able to identify BACnet MSTP devices and their objects.
This will become a problem after network disruptions and controller restarts
- The following synchronizations will no more take place:
 - Calendar synchronization between IP channel and MSTP channel
 - User synchronization between IP channel and MSTP channel
 - Display of all bus-wide alarms of all controllers in the MSTP channel in the web-browser interface

- Procedure**
1. In the tree, expand the *Advanced* item, the *System Settings* item and then the *Diagnostics* item.
 2. Click on *BACnet*.
 3. Click the *Statistics* tab on the right pane.

RESULT: The BACnet statistics for Services, MS/TP and Miscellaneous are shown. The properties show the communication status and indicate communication problems.

In the **Initiated** column, the number of items performed by the Excel Web II (server) is listed. In the **Executed** column, the number of items generated by BACnet clients or other Excel Web II controllers are listed.

Route BACnet Broadcasts

Enable Broadcasts Routing:

Duration: Min. **SUBMIT**

Statistics

Service Name	Initiated	Executed
I-am	1	3
read-prop	6	6
unconf-private-transfer	4	0
who-is	2	0
Ø COV Notifications per Minute	0	0

MS/TP Statistics

-- No Entry --

Miscellaneous

BACnet device ID	1000	
BACnet/IP network / UDP-port	1	47808
max. APDU length / max. segm.	1476	16
APDU timeout / segm. timeout	3000	2000
APDU retries / wnd.size	4	16
num. of COV subscr.	0	
Device List Size / Bindings	1	1
Priv. Transfer (obj.synch./al.)	5	5

4. Enable or disable IP-MSTP broadcast routing by checking or unchecking **Enable Broadcast Routing**.
5. To disable IP-MSTP broadcast routing after a particular time, enter a time in minutes in **Duration**.

View Modbus Data

- Procedure**
1. In the tree, expand the *Advanced* item, the *System Settings* item and then the *Diagnostics* item.
 2. Click on *Modbus*.
 3. Click *Port* tab on the right pane.

RESULT: The Device List of the Modbus is shown with the following properties for each device:

- Address
physical address of the device
- Communication
shows the communication status:
 - online
 - offline

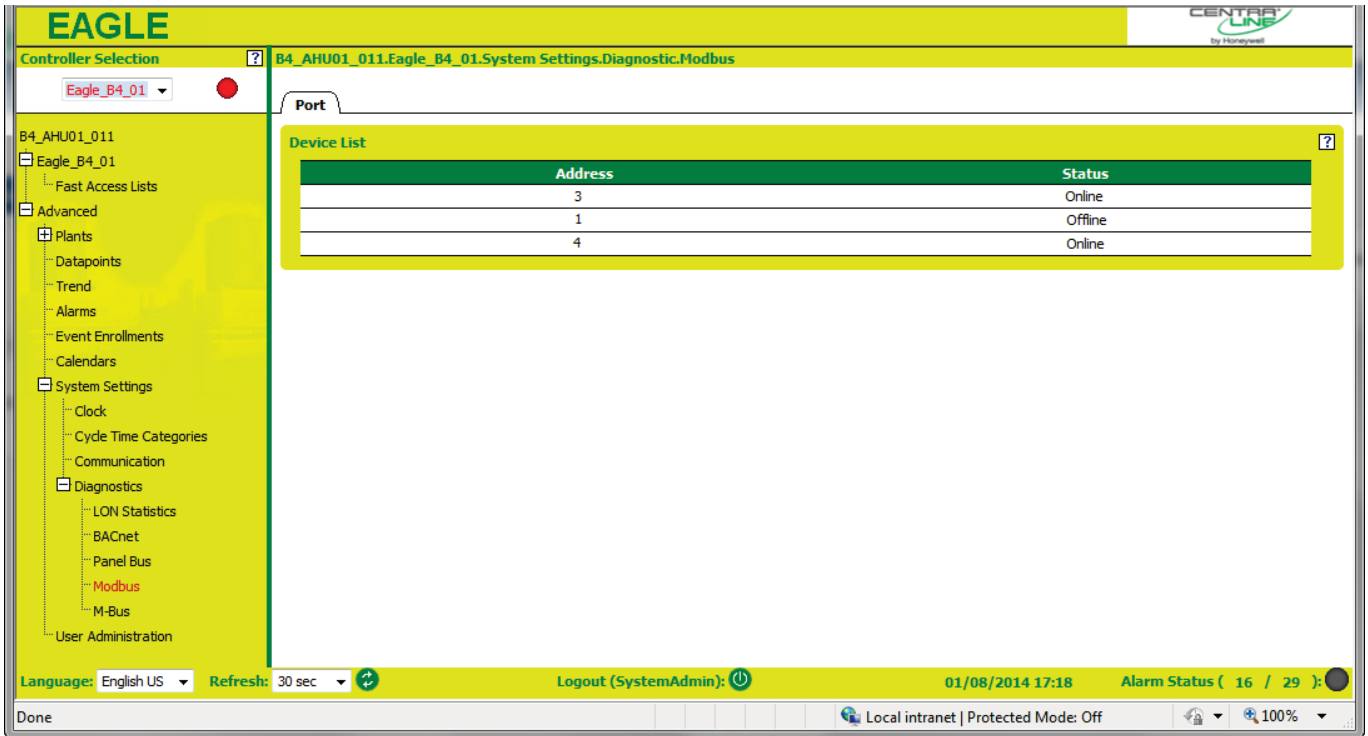

View / Change M-Bus Data

- Procedure**
1. In the tree, expand the *Advanced* item, the *System Settings* item and then the *Diagnostics* item.
 2. Click on *M-Bus*.
- RESULT:** On the *Port* tab on the right pane, the Device List of the M-Bus is shown with the following properties for each device:

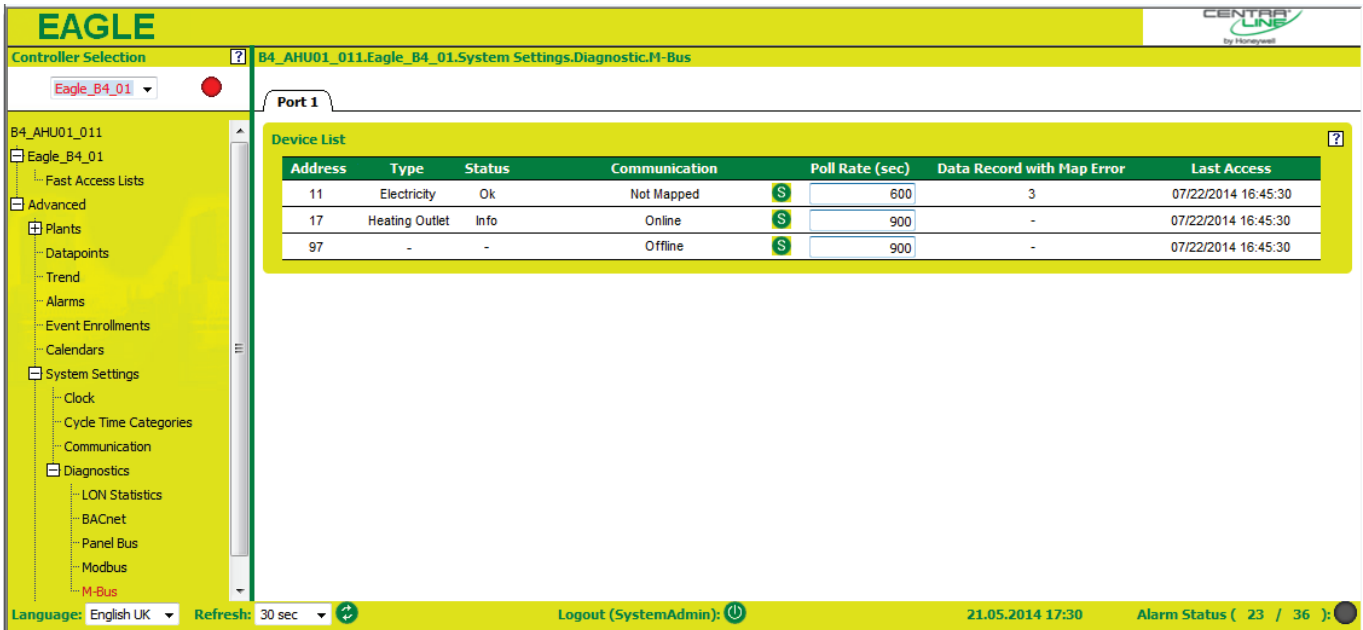

- Address
primary address of the device
- Type
measured medium, e.g. electricity. Assigned by the manufacturer
- Status
Shows the current status of the status byte
 - Ok = all bits are 0
 - Info = at least one bit is 1
 please hover over the line to display a tooltip. The tooltip shows the bits that are set to 1. The bits have the following meaning:

Bit		Meaning
bit 1	bit 0	
0	0	no error
0	1	application busy
1	0	any application error
1	1	reserved
bit 2		low power
bit 3		permanent error
bit 4		temporary error
bit 5		manufacturer specific error
bit 6		manufacturer specific error
bit 7		manufacturer specific error

please refer also to the related technical documentation of the manufacturer and to the actual M-Bus standard documentation: <http://www.m-bus.com/files/MBDOC48.PDF>

- Communication
shows the communication status:
 - online
 - offline
 - not mapped
one or multiple data records mapped in CARE could not be have been mapped in the controller

- Poll Rate (sec)
shows the poll rate for the M-Bus in seconds. To change the poll rate, enter the value in the field and then click the Set Value button.

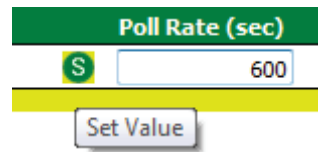

- Data Record with Map Error
shows the number of the first data record which could not have been mapped in the controller
- Last Access
date and time of last access to the device by the controller

Web Server Certificates

Here you can install a trusted CA certificate ordered and received from a certification authority or a self-signed certificate created via an OpenSSL tool such as XCA.

- Procedure**
1. In the tree, expand the *Advanced* item, then the *System Settings* item and click on *Web Server Certificates*.

RESULT: The *Web Server Certificates* tab displays.



2. Follow the instructions described on the tab.

Trend

Please refer also to the "Trending" section, p. 99.

- Procedure** 1. In the tree, expand the *Advanced* item and click on Trend.

RESULT: The *Points in Trend* tab displays.

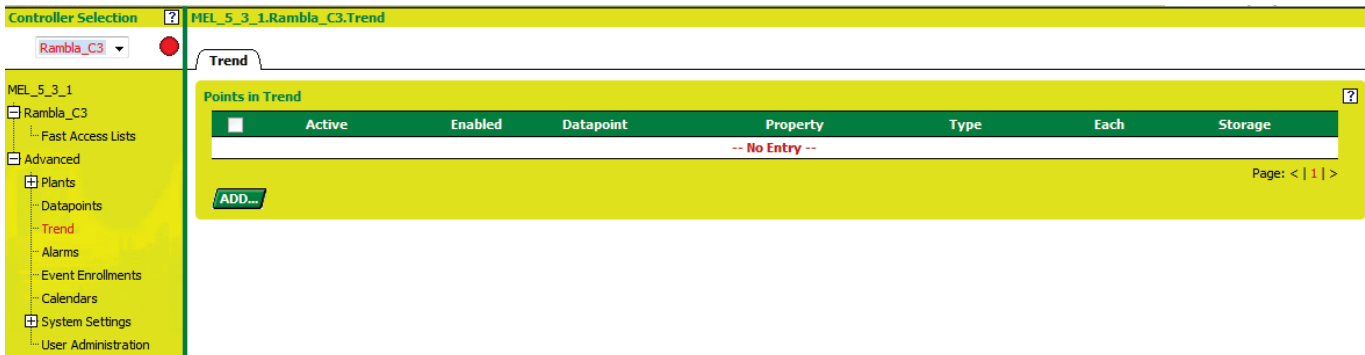

Here you can trend datapoints. Datapoints to be trended can be added and deleted from the Points in Trend list. Trending can be done in two ways, time-based or value-based. When using time-based trending, a datapoint value will be recorded in a defined log interval, e.g. every 30 seconds. When using value-based trending, a datapoint value will be recorded if its value has been exceeded by a certain amount, e.g. 0.1 °C. These values are called trend parameter.

Trending can be done for a defined time range. Trend result (trend records) can be saved in a file.

NOTE:

A trended point is only displayed if the user's access level is equal to or higher than the read access level of the trended point.

2. To add datapoints to the list for trending, click on the ADD button.

RESULT: The *Add Points to Trend* dialog box displays.

3. Under **Datapoint Filter**, define the filter to display desired datapoints to be trended by doing one of the following:
- Under **Plant**, select plant(s) of which datapoints you want to be filtered by clicking the BROWSE button.
 - Under **Point Type**, select the point type to be filtered.
 - Under **Point Name**, specific datapoint names can be filtered by entering a search text. Wildcards can be used for filtering. By default all datapoints will be displayed as indicated by an asterisk. The filter function is case-sensitive. To display specific datapoint names, enter the desired search text.
 - Click the GO Button to apply the filter.

RESULT: All datapoints matching the filter criteria will be displayed under **Datapoint Selection** in the *Available Datapoints* list.

Datapoints are selected/deselected from trend status by moving them between the *Available Datapoints* and the *Selected Datapoints* list.

4. To move datapoints between lists, do the following:
- Highlight the datapoint(s) to be moved in the *Available Datapoints* list. Multiselection by using the CTRL or the SHIFT key is possible.
 - Or, click the checkbox at the point name in the *Selected Datapoints* list.

c. Click the SINGLE ARROW button with the desired direction.

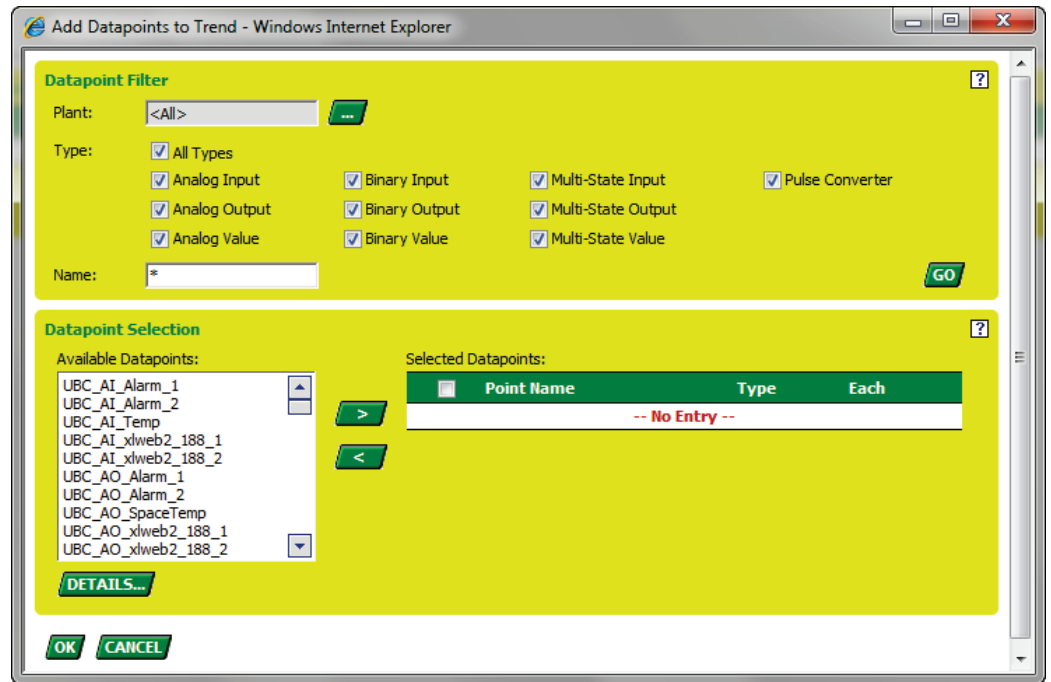

5. Click the OK button.

RESULT: On the *Points in Trend* tab, the datapoints are displayed,

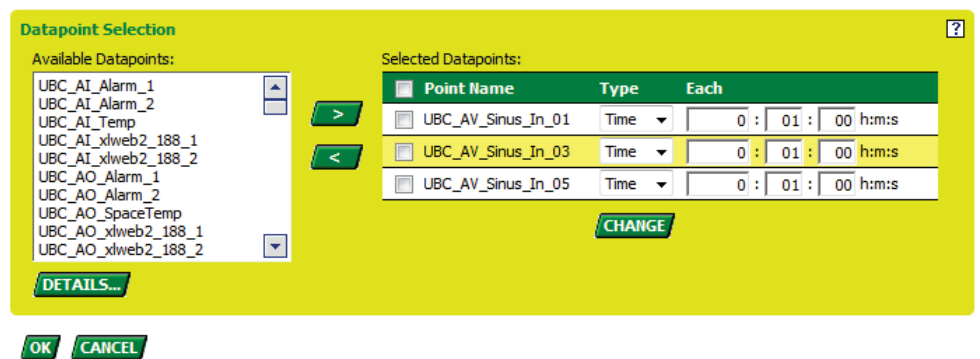

For each datapoint to be trended the following properties are shown:

- Active (state)
Shows whether the datapoint is currently trended or not.
- Enabled
Shows whether the trend logging is enabled or disabled. If enabled, the trending will start/stop in the defined time range.
- Datapoint
Shows the datapoint name. Clicking the datapoint opens the datapoint details dialog for editing.
- Property
Shows the property of the datapoint that will be trended
- Type
Shows the trending type, value = value-based, or time = time-based

By clicking the CHANGE button, the type can be toggled in one step for all datapoints

- Each
Shows the trend parameter
- Details
Clicking on the entry opens the trend details dialog where the datapoint property and general settings such time range, trend type and trend parameter can be defined.

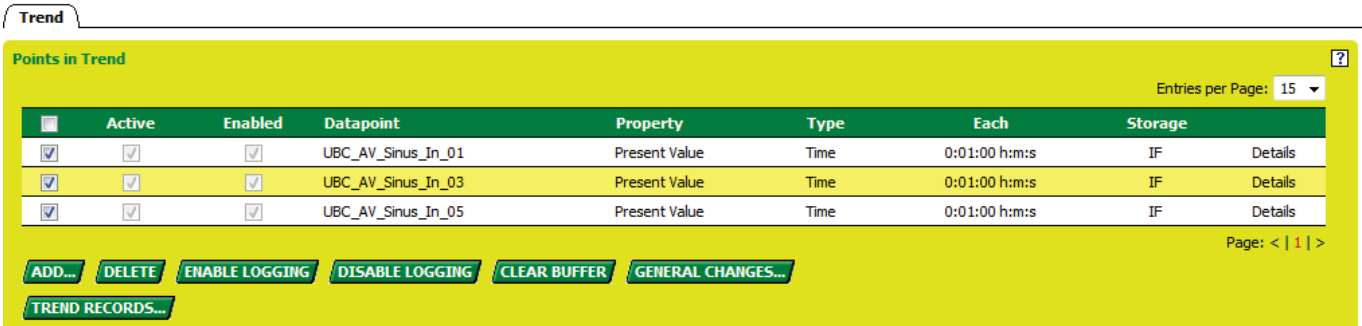

6. To delete a point in trend from the Points in Trend list, click the left checkbox in the datapoint row and click the DELETE button.

7. To enable logging, click the left checkbox in the datapoint's row and click the ENABLE LOGGING button.

RESULT: That datapoint will then be trended in the defined time range as indicated by the checked **Enabled** checkbox.

8. To disable logging, click the left checkbox in the datapoint's row and click the DISABLE LOGGING button.

RESULT: That datapoint will not be trended as indicated by the unchecked **Enabled** checkbox.

NOTE: You can only delete, enable, or disable logging, if your access level is equal to or higher than the write access level of the trended point.

9. To change general trend settings such as time range and buffer settings for multiple datapoints in one step, click the left checkbox in the datapoints' row and click the GENERAL CHANGES button. This function can be used for defining settings for multiple datapoints in one step whereas defining settings for a single datapoint may be done by clicking the datapoint's details in the last column.

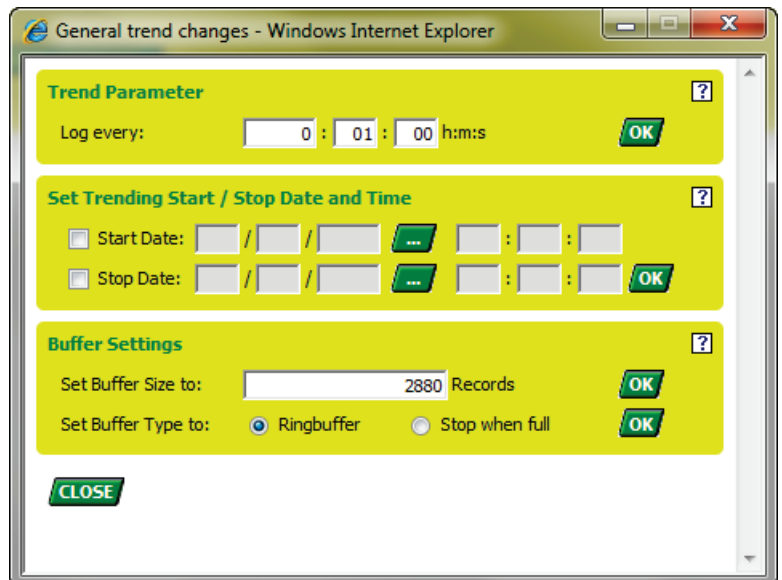

10. Under **Set Trending Start / Stop Date and Time**, define the time range (start and stop date/time) by doing the following:
 - a. Click the **Start Date** checkbox and enter the start date into the fields or select date by clicking the BROWSE button.
 - b. In the **Time** fields enter the time.

NOTE:

If the checkbox is unchecked, the fields are disabled. This means, that trending will be performed up to and including the end date.

- c. Click the **Stop Date** checkbox and enter the end date into the fields or select date by clicking the BROWSE button.
- d. In the **Time** fields enter the time

NOTE:

If the checkbox is unchecked, the fields are disabled. This means, that trending will be performed from the start date on.

NOTE:

If both fields are disabled, trending will start immediately and continues all the time.

- e. Click the OK button.

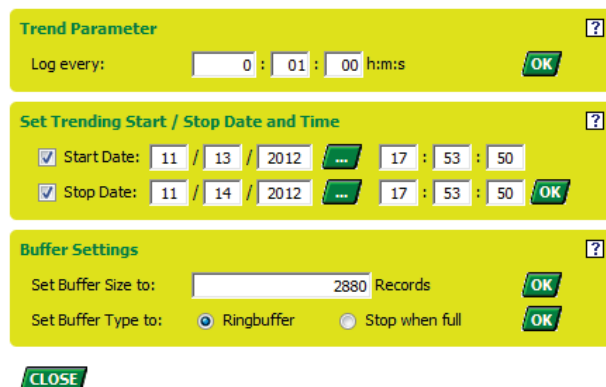

11. Under **Buffer Settings**, you can define the trend buffer settings and clear the buffer for the selected datapoint(s) as follows:

- f. Under **Set Buffer Size to**, enter the max. number of entries of the buffer (trend logging must be disabled). Click the OK button.

NOTE: **The internal flash** memory (2 MB) is capable of storing a maximum of 64,000 trend records distributed among a max. of 497 trend log objects. Each trend record allocates 30 bytes of memory. Based upon the internal flash storage selection, the default value for the max. buffer size is 2880 records, distributed among 24 trend log objects according to the calculation:

$$2 \text{ MB} / 30 / 2880 = 24$$

Based on the preceding calculation, external flash cards with capacities higher than 2 MB enable you to extend the no. of trend log objects and trend records to be saved.

IMPORTANT

Irrespective of the buffer size and the storage mode selected (internal or external flash, step d), it is recommended not to increase the default buffer size. Increasing the value above 2880 results in decreased performance when viewing and browsing trend record pages and creates additional effort when manually downloading trend records into a csv. file on the PC (step 21).

The maximum no. of storable trend records per download is 1550 independent of the no. of trend log objects selected. To reduce the no. of manual downloads necessary for the total download of trend records exceeding the max. no. of 1550, the date range can be set accordingly (step 19).

- g. Under **Set Buffer Type to**, select the buffer type under:

Ringbuffer

The oldest record will be overwritten by the latest record when the buffer size is exceeded.

Stop when full

Trending is stopped when the buffer size is exceeded.

- h. Click the OK button.

13. To view/change trend details of a single datapoint, click on its Details entry in the last column.

RESULT: The *Trend Details* dialog box displays.

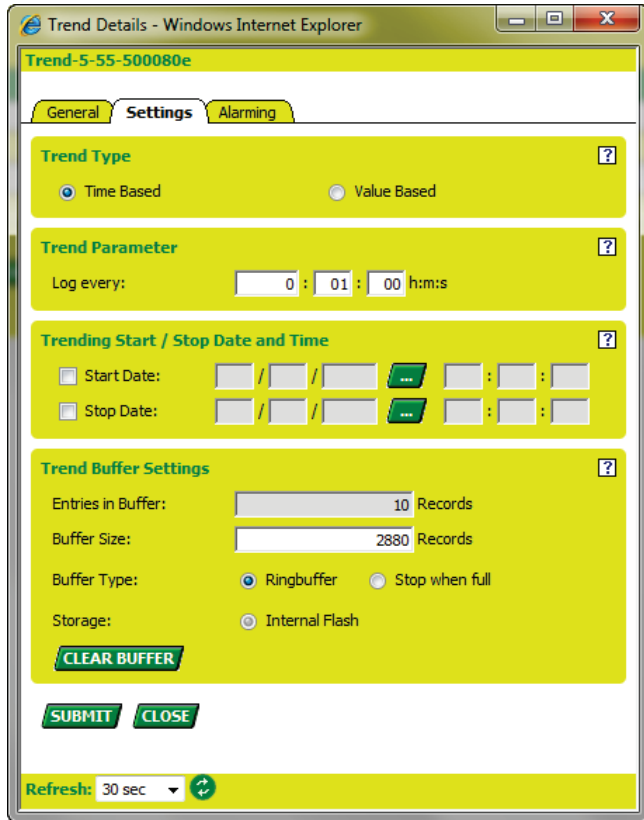

14. Define trend settings for the single datapoint as follows:

Trend Type

- a. Select trend type, time-based or value-based, by clicking the radio button.

When using time-based trending, a datapoint value will be recorded in a defined log interval, e.g. every 30 seconds. When using value-based trending, a datapoint value will be recorded if its value has been exceeded by a certain amount, e.g. 0.1 °C. These values are called trend parameter.

Trend Parameter

- b. Enter the trend parameter value.
- c. Depending on the trend type, time-based or value-based, enter the settings:

Time-based

In the **Log every** field, enter the time interval in h:m:s after which the value should be logged.

Value-based

In the **Log change greater** field, enter the range in excess of which the value should be logged. Each time the value change is greater than the value defined here, a trend value is logged into the trend buffer.

NOTE: For the log interval setting, the following guideline should be considered:

Based on the default log interval for time-based trending (1 minute) and the max. no. of trend log objects (497), a maximum of 8 trend records per second can be created:

$$497/60 = 8 \text{ (limiting factor)}$$

For value-based trending, the default log interval should be estimated roughly by noting the no. of value changes which occurred within an appropriate time period.

Any calculations should result in a limiting factor of less than 8 (trend records per second).

Example:

You have a trend setting of 40 trend log objects with 1 trend record per minute plus 20 trend log objects with 1 trend record per 2 minutes. The result is an addition of the values as follows:

$$40/60 + 20/120 = 0.833 \Rightarrow \text{less than } 2$$

Trending Start / Stop Date and Time

Here you can define the time range (start and stop date/time) of the trending.

To define the time range, do the following:

- d. Click the **Start Date** checkbox and enter the start date into the fields or select date by clicking the BROWSE button.
- e. In the **Time** fields enter the time.

NOTE:

If the checkbox is unchecked, the fields are disabled. This means, that trending will be performed up to and including the end date.

- f. Click the **Stop Date** checkbox and enter the end date into the fields or select date by clicking the BROWSE button.
- g. In the **Time** fields enter the time

NOTE:

If the checkbox is unchecked, the fields are disabled. This means, that trending will be performed from the start date on.

NOTE:

If both fields are disabled, trending will start immediately and continues all the time.

If clicking the ENABLE LOGGING button enables the trend logging, the trending starts as soon as the start date/time is reached and ends at stop date/time. During trending the status is active as indicated as checked Active.

Stop of Trending is done by clicking the DISABLE LOGGING button (Status: Enabled=unchecked, Active=unchecked).

Trend Buffer Settings

Here you can define the trend buffer settings and clear the buffer.

Under **Entries in Buffer**, the current number of records is displayed.

Under **Buffer Size**, the max. buffer size can be set (trend logging must be disabled).

- h. Enter buffer size.

NOTE: The internal flash memory (2 MB) is capable of storing a maximum of 64,000 trend records distributed among a max. of 497 trend log objects. Each trend record allocates 30 bytes of memory. Based upon the internal flash storage selection, the default value for the max. buffer size is 2880 records, distributed among 24 trend log objects according to the calculation:

$$2 \text{ MB} / 30 / 2880 = 24$$

Based on the preceding calculation, external flash cards with capacities higher than 2 MB enable you to extend the no. of trend log objects and trend records to be saved.

IMPORTANT

Irrespective of the buffer size and the storage mode selected (internal or external flash), it is recommended not to increase the default buffer size. Increasing the value above 2880 results in decreased performance when viewing and browsing trend record pages and creates additional effort when manually downloading trend records into a csv. file on the PC (step 21).

The maximum no. of storable trend records per download is 1550 independent of the no. of trend log objects selected. To reduce the no. of manual downloads necessary for the total download of trend records exceeding the max. no. of 1550, the date range can be set accordingly (step 19).

- i. Select buffer type under:

Ringbuffer

The oldest record will be overwritten by the latest record when the buffer size is exceeded.

Stop when full

Trending is stopped when the buffer size is exceeded.

Internal Flash

The trend results are saved on the internal flash.

See previous Buffer Size Note.

- j. To clear the buffer, click the CLEAR BUFFER button.

- 15. Click on the *General* tab to define general trend settings as follows:

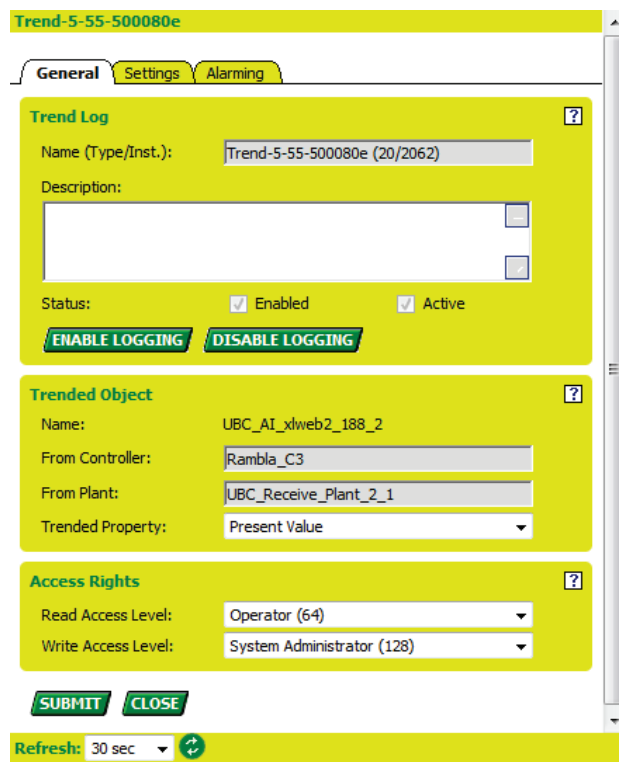

Trend Log

In **Name** and **Description**, the trend log name and its description are shown. In **Type/Instance**, the type and instance is shown.

- a. Change the name and/or the description if desired
- b. Enable trending by clicking the ENABLE LOGGING (Status: Enabled=checked).

If the trend logging is enabled, the trending starts as soon as the start date/time is reached and ends at stop date/time. During trending the status is active as indicated by the checked **Active** option.

- c. Manually stop trending by clicking the DISABLE LOGGING button (Status: Enabled=unchecked, Active=unchecked).

Start and Stop Date/Time is defined under **Trending Start / Stop Date and Time** on the *Settings* tab.

Trended Object

Here data about the trended object is displayed, such as:

Name

Shows the name of the trended object

From Controller

Shows the controller which the trend object belongs to

From Plant

Shows the plant which the trend object belongs to

Trended Property

Shows the property which is to be/has been trended. The property can be changed.

Access Rights

Here you can issue the access rights of the trend object

- d. From the **Read Access level** drop-down list box, select the user level that should have the read access of the trend object.
- e. From the **Write Access level** drop-down list box, select the user level that should have the write access of the trend object

- 15. Click on the *Alarming* tab to set the alarming for forwarding trend information to the BACnet client:

Intrinsic Reporting

- a. In Notification Class, select a notification class
- b. In Notification Threshold, enter the number of notifications before sending a new alarm
- c. In Notify Type, select the notify type

In Records since Notification, the number of trend records since the last sent alarm, is shown.

In Last Notify record, the number of notified trend samples since the last alarm is shown

d. Under Transitions, in the Reporting column, check the transitions that should be reported. In the Ackn column, check whether a transition must be acknowledged or not.

16. Click the SUBMIT button to save settings and then the CLOSE button.

RESULT: The *Points in Trend* tab redispays.

17. To clear the trend buffer, click the left checkbox in the datapoint's row and click the CLEAR BUFFER button. The buffer of that datapoint is now cleared.

18. To display trend records, click the left checkbox in the datapoint's row and click the TREND RECORDS button.

RESULT: The *Trend Records* dialog box displays. Here you can display trended values for a defined time range.

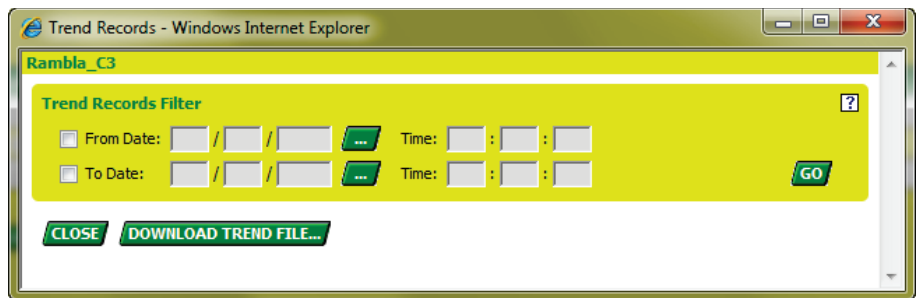

19. To define the time range, for which the trended records should be shown, do the following (see also Buffer Size Note, step 11):

- a. Click the **From Date** checkbox and enter the start date into the fields or select date by clicking the BROWSE button.
- b. In the **Time** fields enter the time.

NOTE:
If the checkbox is unchecked, the fields are disabled. This means, that trended records will be shown up to and including the end date.

- c. Click the **Stop Date** checkbox and enter the end date into the fields or select date by clicking the BROWSE button.
- d. In the **Time** fields enter the time

NOTE:
If the checkbox is unchecked, the fields are disabled. This means that trended records will be shown from the start date on.

NOTE:
If both fields are disabled, trended records will be shown immediately and continues all the time.

20. To display trend records for the defined time range, click the GO button.

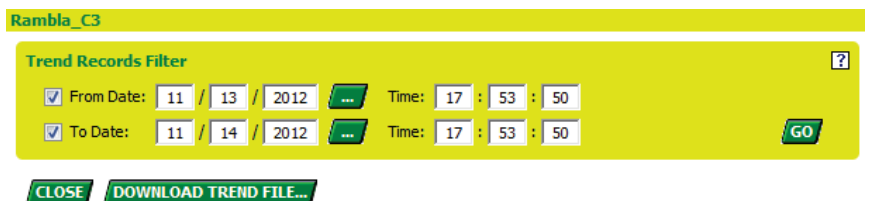

RESULT: Under **Trend Records**, for each datapoint selected, the trended present value or the enable/disable trend status is shown (see next page).

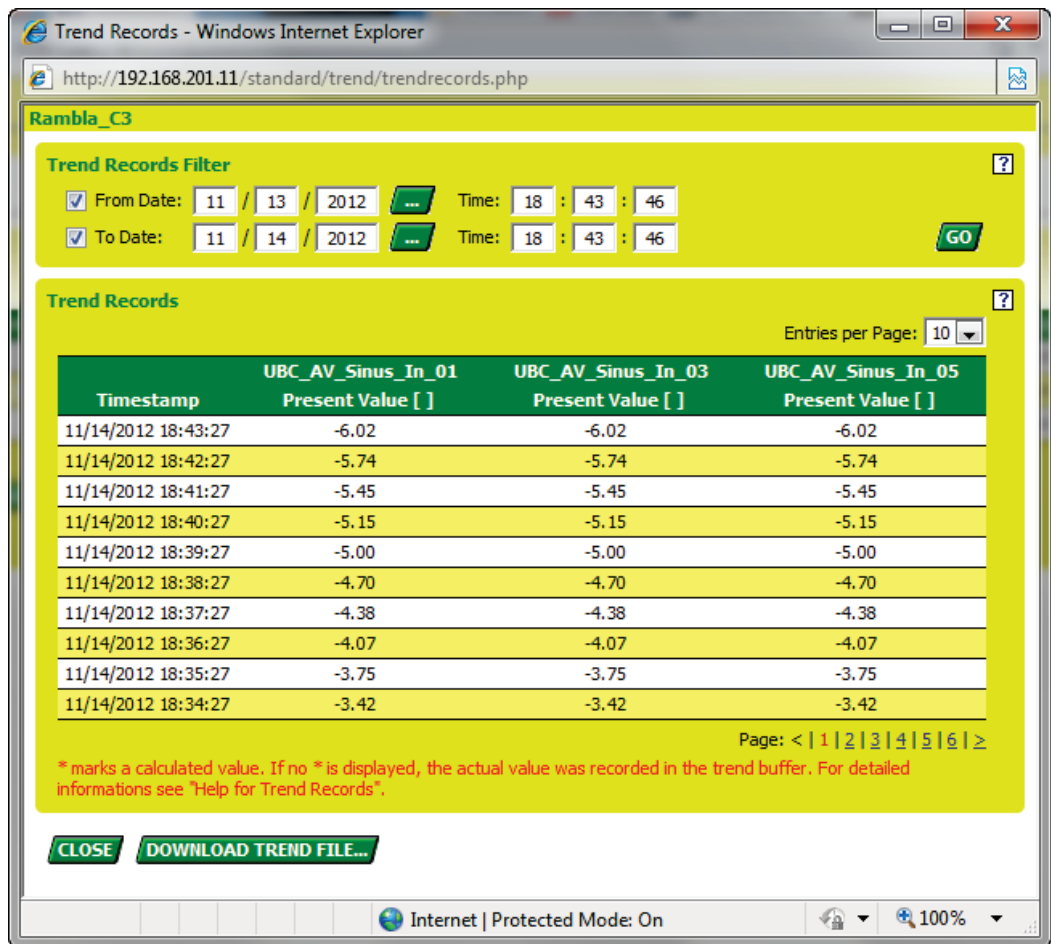

21. To save the records, click the **DOWNLOAD TRENDFILE** button and save the file to the desired location (see also Buffer Size Note, step 11).
22. Click the **CLOSE** button to redisplay the *Points in Trend* tab.

Alarms

Please refer also to the "Alarm Handling" section, p.85.

- Procedure**
1. In the tree, expand the *Advanced* item and click on Alarms.

RESULT: On the *Alarm Buffer* tab on the right, the alarms are displayed. The alarm buffer is a ring buffer with a capacity of 100 event entries.

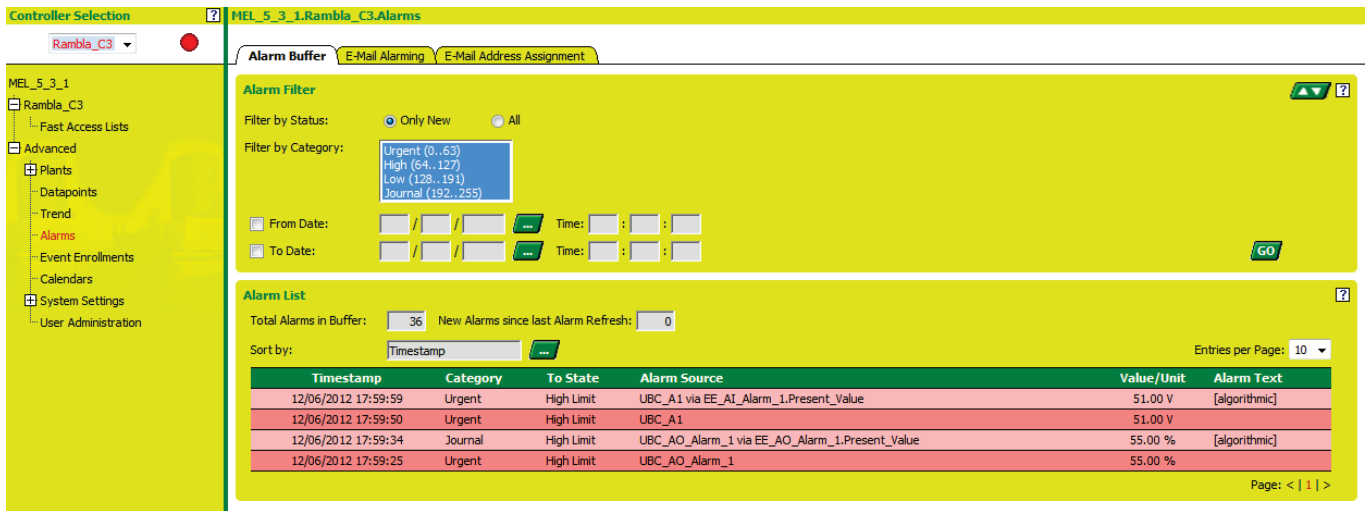

Alarm Filter

Here you can create an alarm filter for displaying alarms by status (new, all), category (urgent, high, low) and by time range in the alarm list.

- Under **Filter by Status**, select the status by clicking the radio button:

Only New

Displays new alarms of the defined time range.

All

Displays all alarms, regardless of their status, of the defined time range.

- Under **Filter by Category**, mark the category under:

Urgent

Displays all alarms with urgent priority

High

Displays all alarms with high priority

Low

Displays all alarms with low priority

Multiselection by using the SHIFT or the CTRL key is possible.

- To define the time range, do the following:

e. Click the **Start Date** checkbox and enter the start date into the fields or select date by clicking the BROWSE button.

f. In the **Time** fields enter the time.

NOTE:

If the checkbox is unchecked, the fields are disabled. This means, that alarms of any date up to and including the end date, will be displayed.

g. Click the **Stop Date** checkbox and enter the end date into the fields or select date by clicking the BROWSE button.

h. In the **Time** fields enter the time.

NOTE:

If the checkbox is unchecked, the fields are disabled. This means, that alarms of any date from the start date on will be displayed.

NOTE:

If both fields are disabled, all alarms of the alarm buffer will be displayed.

- To display the alarms under **Alarm List**, click the GO button.

Alarm List

Here the alarms are displayed according to the applied alarm filter. The alarm list shows the most important properties of an alarm. Viewing the timestamp can show more details. On the top, the total number of alarms in the buffer and the number of new alarms since the last refresh are displayed.

For each alarm, the following properties are shown in the list:

Timestamp

Shows the time, when the alarm has occurred. Newer alarms are highlighted in red. By clicking on the entry, alarm details can be viewed.

Category

Shows the category of the alarm:

- Urgent
Alarm has urgent priority (range 0...84)
- High
Alarm has high priority (range 85...169)
- Low
Alarm has low priority (range 170...250)

ToState

Shows the state of the alarm:

- Normal
The alarm is going to normal state, e.g. the value of the datapoint remains under the high alarm limit
- To off-normal
The alarm reaches off-normal state, e.g. the high alarm limit value is exceeded
- Fault
The alarm originates in a fault such as sensor break, etc.

Alarm Source

Shows the datapoint name

Value/Unit

Shows the value and unit. In case of BI, BV, MI, MV, it may be a new value, in case of AI, AO, AV it may be an exceeding value, in case of BO, MO, it may be a command value.

Alarm Text

Shows the alarm message as defined in the Engineering tool.

The list can be sorted differently by clicking on the BROWSE button at the **Sort By** field.

View Alarm Details

Procedure 1. In the **Alarm List**, click on the alarm entry in the *Timestamp* column.

RESULT: The *Alarm Details* dialog box displays. Here alarm details can be viewed under:

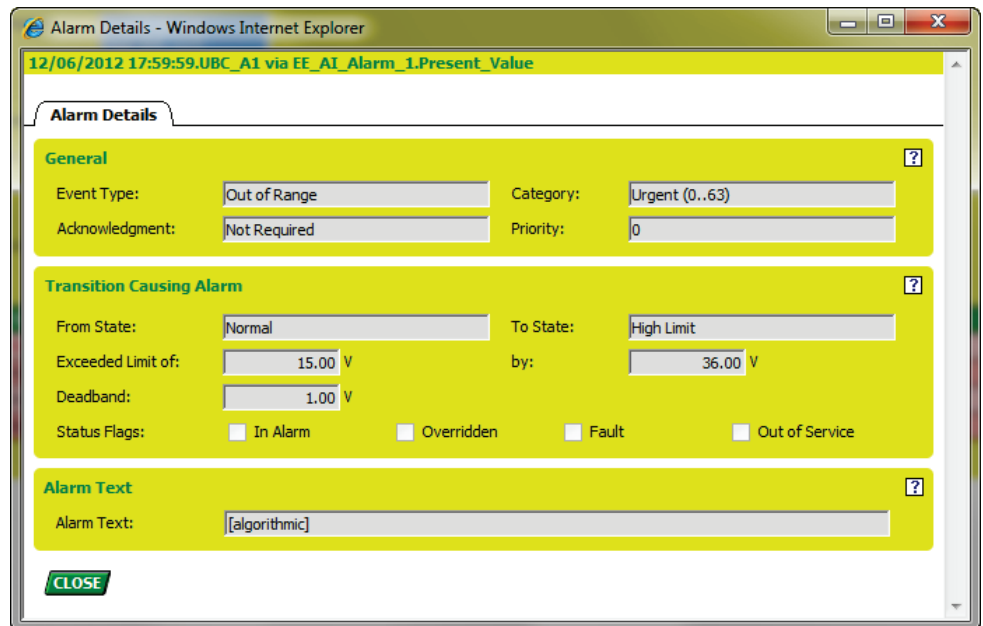

General

Displays alarm details, such as event type, alarm reason and alarm text.

Event Type

Different datapoints may cause different event types as shown in the following:

- Change of state
Present value has changed to a new state for longer than the time delay.
Can be caused by BI, BO, BV, MI, MO, and MV.
- Out of range
Present value has exceeded range between high limit and low limit for longer than the time delay.
Or, present value has returned between the high limit - deadband and the low limit + deadband range for longer than the time delay.
Can be caused by AI, AO, and AV.
- Command failure
Present value differs from feedback value for longer than the time delay.
Can be caused by AO, BO, MO.
- Acknowledged
(Not required)

NOTE:

Alarm acknowledgement is not applicable, hence alarms are set to NO by default.

Category

Shows the category:

- Urgent
Alarm has urgent priority (range 0...84)
- High
Alarm has high priority (range 85...169)
- Low
Alarm has low priority (range 170...250)

Priority

Depending on the category, the alarm states NORMAL, OFF-NORMAL, FAULT have different values in the corresponding priority range. Hence, the priorities of the transitions (changes from one state to another state) are as follows:

Event (Alarm) Category	Transitions		
	To Normal	To Off-Normal	To Fault
Urgent (range 0...84)	83	0	42
High (range 85...169)	168	86	127
Low (range 170...250)	250	171	210

Transition Causing Alarm

Displays the transition causing the alarm. Different datapoints may cause different event types as shown in the following:

Change of state

Present value has changed to a new state for longer than the time delay.
Can be caused by BI, BV, MI, and MV.

Out of range

Present value has exceeded range between high limit and low limit for longer than the time delay.
Or, present value has returned between the high limit - deadband and the low limit + deadband range for longer than the time delay.
Can be caused by AI, AO, and AV.

Command failure

Present value differs from feedback value for longer than the time delay.
Can be caused by AO, BO, and MO.

From State ... To State

Describes the event transition.

Examples:

From Normal to Off-normal
From Off-normal to Normal

New Value

Displays the new state of the datapoint, e.g. stage 1.

Deadband

Shows the deadband

Status Flags

Shows the set status flags:

- In Alarm
When enabled, the datapoint is in alarm. Cause can be faults and Off-Normal conditions.
- Fault
When enabled, the datapoint or the physical input is not reliable, e.g. in case of sensor break (Open Loop).
- Overridden
When enabled, the datapoint is in manual operating state. The value has been overwritten.
- Out of Service
When enabled, the physical input is decoupled from the datapoint, e.g. in case of manual override for inputs. The present value displayed is not the present value, which would be delivered by the physical input.

NOTE: Multiple flag indications may be possible.

Example:

A 'To-Fault transition' causes also always an alarm. Hence both, the 'In Alarm' and the 'Fault' status flags are enabled.

Alarm Text

Displays the alarm text (message) and the alarm description.

2. Click the CLOSE button after having viewed the alarm details.

Control Loops

Please refer also to the "Control Loops" section, p. 99.

View Control Loop Information

- Procedure**
1. In the tree, expand the *Advanced* item and navigate to the control loop, you want to display.
 2. Click on the control loop.
- RESULT:** On the right, the Control Loop displays information such as name and description, execution parameters and access rights.

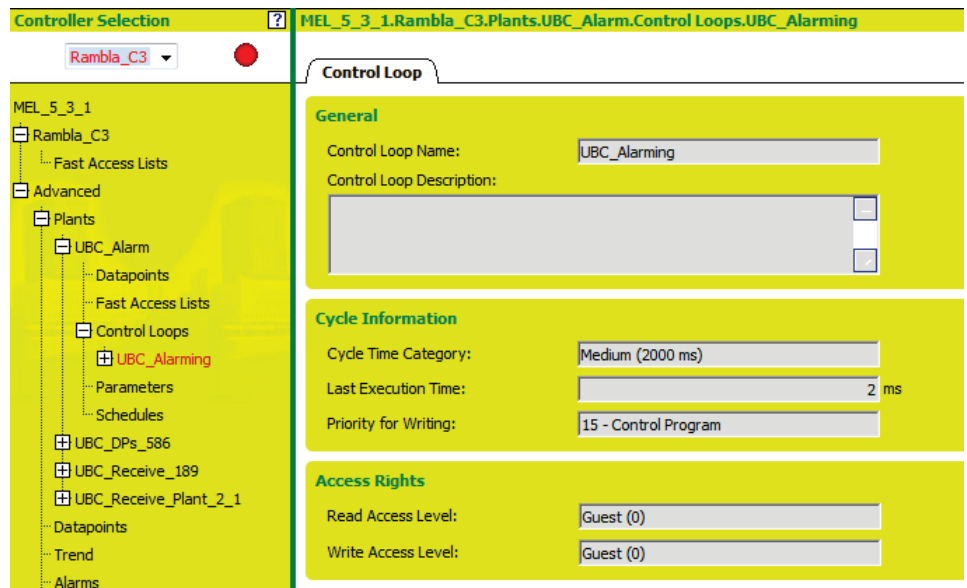

General

Displays name and description of the control loop.

Cycle Information

- **Cycle Time Category**
The cycle time category defines in ms how often the loop will be automatically executed by the controller. Cycle times are grouped in the following categories: Slow, Medium, Fast, and Very Fast.
- **Last Execution Time**
This is the actual execution time in ms of the loop. Allows, e.g. detecting overruns by comparing the actual execution time with the assigned cycle time.
- **Priority for Writing**
Displays priority with which the loop writes to the output.

Access Rights

Displays access rights.

NOTE:

Control loop information will only be displayed, if the access level of the user is equal to or higher than the read access level of the control loop.

Changing control loop information is only possible if the user's access level is equal to or higher than the write access level of the control loop.

Parameters

Parameters are used for configuration and tuning of the application program via control loop. A typical example of a parameter is the Integral Time of the PID control function.

Parameters are part of a control icon which itself is part of a control loop which itself is part of a plant, etc. Hence, the parameter can be described and addressed by its path as follows:

plant – control loop – control macro - control icon – parameter

Example: airconditioning.contloop1.supply_temp.integral time

A parameter is defined by:

- Name
- Value
- Engineering unit/state text

Parameters belong to control icons and define the icon behavior. Control icons will be interconnected within a control loop that performs a control program. A control loop itself can also have parameters. Control icons can internally be composed of other icons (control macro). For example, a XFM is a control macro. Control macros can have max. 4 internal control icons. It will not be distinguished between parameters of input and output control icons. Parameters can be written to and read from the control program. However parameters cannot be prioritized. The parameters origin (location) will be shown as path with the following structure: plant-control loop-control icon.

NOTE:

If no parameters are displayed, one of the following may be the reason:

A) You do not have the user rights to read control loops and parameters

or

B) All or some of the parameters have been intentionally engineered in CARE not to be displayed in the Eagle Web Interface.

Procedure

1. In the tree, expand the *Advanced* item, then the *Plants* item and navigate to the Parameters item.
2. Click on Parameters.

RESULT: On the right, the *Parameters* tab displays. Here you can display and edit parameters. Under **Display Settings**, you define the display type. Under **Parameters**, the parameters are displayed according to your display type selection. Here parameter values can be changed too.

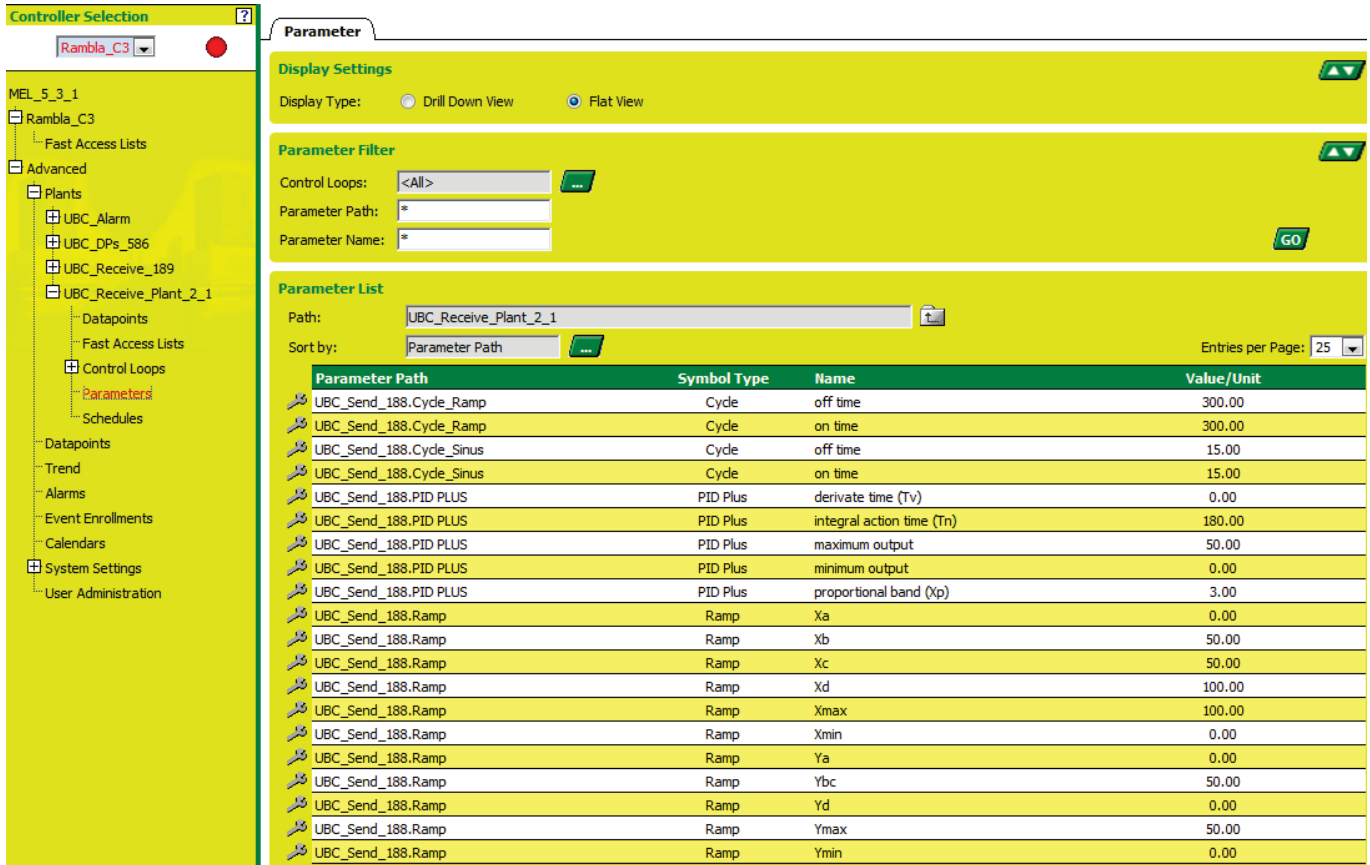

Display Settings

a. Select how the parameters should be displayed by clicking corresponding radio button:

Drill Down View

Displays parameters of the plant/control loop as hierarchical structure. Parameters can be accessed by navigating through the hierarchical structure. Only the parameters of the current selected level (plant or control loop) are displayed.

Example:

Since the plant itself has no parameters, on plant level only the control icons are displayed as folders.

Flat View

Displays parameters of the plant as non-hierarchical structure. All parameters of selected loops are listed concurrently with their path. Parameters can be filtered by control loop assignment, path and name.

NOTE: Only the parameters of those control loops are displayed of which read access level is equal to or lower than the access level of the user.

You can only change values of parameters that belong to control loops of which read access level is equal to or lower than the access level of the user.

Parameters (Drill Down View)

If Drill Down View has been selected as display type, the parameters of the plant are displayed as hierarchical structure (drill down view). A tool icon indicates parameters. Folder icons below the parameters indicate control macros. Parameters can be accessed by navigating through the hierarchical structure. While navigating, the current path (separated by dots) will be

displayed in the **Path** field. Downward navigation is done by clicking on the entry in the *Name* column. Upward navigation is done by clicking on the *Upward* icon at the **Path** field.

The screenshot shows the 'Parameter' section of the Eagle Web Interface. On the left, a tree view shows the hierarchy: MEL_5_3_1 > Rambla_C3 > Fast Access Lists > Advanced > Plants > UBC_Alarm, UBC_DPs_586, and UBC_Receive_189. The main area is titled 'Parameter' and contains 'Display Settings' with 'Drill Down View' selected and 'Flat View' unselected. Below that is the 'Parameter List' section, which has a 'Path' field containing 'UBC_Receive_Plant_2_1' and a table with columns 'Symbol Type', 'Name', and 'Value/Unit'. The table contains one entry: 'UBC_Send_188'.

For parameters the following properties are shown:

Name

To edit a parameter, click on its name in the *Name* column.

Value/Unit

Current value and associated engineering unit (analog) / state text (discrete)

Symbol Type

Shows the control icon name which the parameter belongs to. If the parameter belongs to a loop, LOOP will be displayed.

Parameter Filter

If Flat View has been selected as display type, you can define a filter for displaying parameters filtered by control loop assignment, path and name.

- b. Under **Control Loops**, click the BROWSE button to select the control loop(s) of which parameters you want to display.

Under **Parameter path**, parameters of a specific path can be filtered by entering a search text. By default all paths will be displayed as indicated by an asterisk.

- c. To display specific parameters filtered by the path, enter the appropriate search text.

Under **Parameter Name**, specific parameter names can be filtered by entering a search text. By default all parameters will be displayed as indicated by an asterisk.

- d. To display specific parameters filtered by the name, enter the appropriate search text.

- e. To apply the filter, click the GO button.

Parameters (Flat View)

If Flat View has been selected as display type, the parameters of the plant are displayed as non-hierarchical structure (flat view).

All parameters of selected loops are listed concurrently with their path.

Parameters can be accessed by navigating through the path. While navigating, the current path (separated by dots) will be displayed in the **Path** field.

Downward navigation is done by clicking on the entry in the *Parameter Path* column. Upward navigation is done by clicking on the *Upward* icon at the **Path** field. When the parameter is reached by clicking on the corresponding entry under **Parameter Path**, it is always displayed on top of the list and the path shows one dot. Control icons and control macros always follow parameters in the list and their path is shown accordingly.

Parameter

Display Settings

Display Type: Drill Down View Flat View

Parameter Filter

Control Loops: <All>

Parameter Path: *

Parameter Name: *

Parameter List

Path: UBC_Receive_Plant_2_1

Sort by: Parameter Path

Entries per Page: 25

Parameter Path	Symbol Type	Name	Value/Unit
UBC_Send_188.Cycle_Ramp	Cycle	off time	300.00
UBC_Send_188.Cycle_Ramp	Cycle	on time	300.00
UBC_Send_188.Cycle_Sinus	Cycle	off time	15.00
UBC_Send_188.Cycle_Sinus	Cycle	on time	15.00
UBC_Send_188.PID PLUS	PID Plus	derivate time (Tv)	0.00
UBC_Send_188.PID PLUS	PID Plus	integral action time (Tn)	180.00
UBC_Send_188.PID PLUS	PID Plus	maximum output	50.00
UBC_Send_188.PID PLUS	PID Plus	minimum output	0.00
UBC_Send_188.PID PLUS	PID Plus	proportional band (Xp)	3.00

f. The parameters can be sorted column wise. To sort the list, click the BROWSE button at the **Sort by** field.

For parameters, the following properties are shown:

Parameter Path

Shows the path of the parameter. By clicking on the entry, you can browse downwards the path.

Name

To edit a parameter, click on its name in the *Name* column

Value/Unit

Current value and associated engineering unit (analog) / state text (discrete)

Symbol Type

Shows the control icon name which the parameter belongs to. If the parameter belongs to a loop, LOOP will be displayed.

Change Parameter

Procedure

1. In the list under **Parameters**, click on the parameter in the *Name* column. If the parameters are not displayed, navigate through the parameter path by clicking as follows:

g. Downward navigation is done by clicking on the entry in the *Parameter Path* (Flat view) column or *Symbol Type* column (Drill Down View). Upward navigation is done by clicking on the *Upward* icon at the **Path** field. When the parameter is reached it is displayed and accessible in the *Name* column.

Parameter Path	Symbol Type	Name
UBC_Send_188.Cycle_Ramp	Cycle	off time
UBC_Send_188.Cycle_Ramp	Cycle	on time
UBC_Send_188.Cycle_Sinus	Cycle	off time
UBC_Send_188.Cycle_Sinus	Cycle	on time
UBC_Send_188.PID PLUS	PID Plus	derivate time (Tv)
UBC_Send_188.PID PLUS	PID Plus	integral action time (Tn)
UBC_Send_188.PID PLUS	PID Plus	maximum output

2. In the *Name* column, click on the parameter you want to change.

RESULT: The Parameter Value dialog displays.

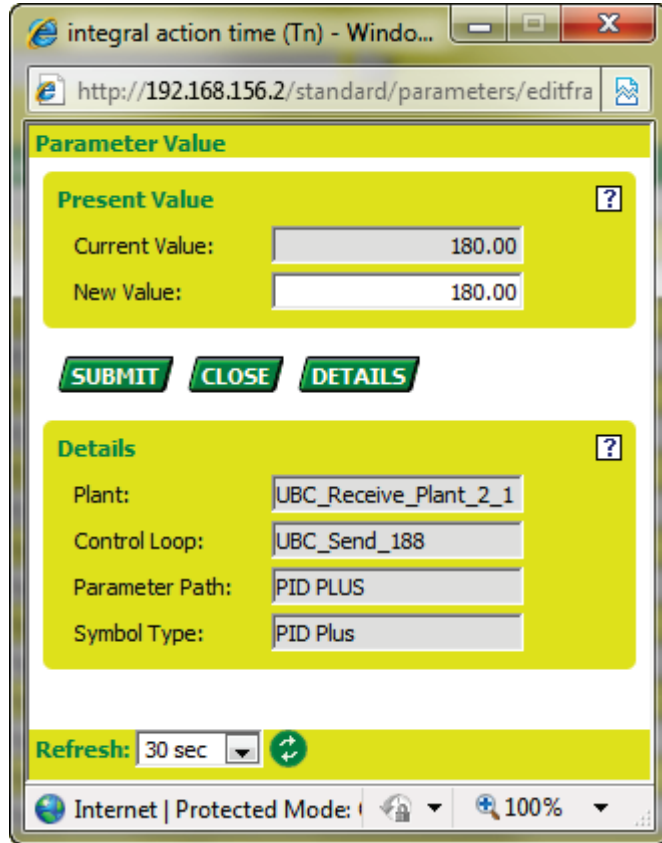

3. Click the DETAILS << button, if you want to display additional information such as plant name, control loop name, parameter path and symbol type.

Example: If a parameter belongs to the symbol 'boiler switch' (SWI) which is part of the symbol 'XFM21', which is part of the control macro 'heating circuit', which is subprogram of control loop 'loop 1' which controls the plant 'plant 3', the following is shown:

Symbol Type: SWI
 Parameter Path: Heating Circuit.XFM.Sub01.Boilwer Switch
 Control Loop: Loop 1
 Plant: Plant 3

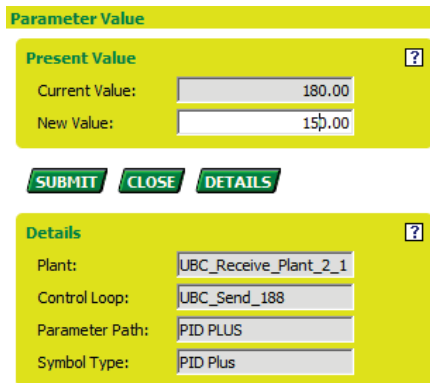

4. In the **New Value** field, enter the parameter value and click the SUBMIT button.

RESULT: The parameter is updated in the parameter list.

Parameter Path	Symbol Type	Name	Value/Unit
UBC_Send_188.Cycle_Ramp	Cycle	off time	300.00
UBC_Send_188.Cycle_Ramp	Cycle	on time	300.00
UBC_Send_188.Cycle_Sinus	Cycle	off time	15.00
UBC_Send_188.Cycle_Sinus	Cycle	on time	15.00
UBC_Send_188.PID PLUS	PID Plus	derivate time (Tv)	0.00
UBC_Send_188.PID PLUS	PID Plus	integral action time (Tn)	150.00

Loop Objects

Purpose The loop object provides the PID control function for usage on the BACnet bus. For detailed description of the PID control function, please refer to the Control Icons User Guide. For descriptions of BACnet terms, please refer to standard BACnet documentation (e.g. the BACnet ANSI / ASHRAE Standard).

The loop object can only be used in one and the same controller. Hence, datapoints from other controllers cannot be assigned to the loop object.

View/Edit Loop Object

- Procedure**
1. In the tree, expand the *Advanced* item and navigate to the plant that contains the loop objects.
 2. Click **Loop Objects** folder.

RESULT: On the right, the Loop Objects tab displays.

The screenshot shows the 'Loop Objects' configuration page in the Eagle Web Interface. The left sidebar contains a tree view with 'Loop Objects' selected. The main content area displays a 'Loop Objects Filter' and a 'Loop Objects List' table. The table lists three loop objects: Loop Object_EXT, Loop Object_TPC, and Loop Object_XPS, with their respective manipulated and controlled values, units, and setpoints.

Name	Description	Manipulated Value	Unit	Controlled Value	Unit	Setpoint Value	Unit	Event State	ALM	FLT	OVR	OOS
Loop Object_EXT		100.00	%	0.00	V	21.00	°C	Low Limit	<input checked="" type="checkbox"/>	<input type="checkbox"/>	<input type="checkbox"/>	<input type="checkbox"/>
Loop Object_TPC		100.00	%	0.00	°C	21.00	°C	Normal	<input type="checkbox"/>	<input type="checkbox"/>	<input type="checkbox"/>	<input type="checkbox"/>
Loop Object_XPS		100.00	°C	0.00	°C	21.00	°C	Normal	<input type="checkbox"/>	<input type="checkbox"/>	<input type="checkbox"/>	<input type="checkbox"/>

On the Loop Objects tab, the loop objects are displayed in the below Loop Objects List.

For each loop object, the following properties are shown:

- **Name**
Shows whether the datapoint is currently trended or not.
- **Description**
Shows whether the trend logging is enabled or disabled. If enabled, the trending will start/stop in the defined time range.
- **Manipulated Value / Unit**
Shows the manipulated value of the assigned output datapoint.
- **Controlled Value / Unit**
Shows the controlled value of the assigned input datapoint.
- **Setpoint Value / Unit**
Shows the setpoint value of the assigned input datapoint
- **Event State**
Shows the event state (Normal, To-Off-Normal, Back-To-Normal)
- **ALM, FLT, OVR, OOS**
Status flags indication for alarm, fault, overridden and out of service.

3. In the upper Loop Objects Filter area, you can filter loop objects as follows:

- h. In **Name**, enter a name to filter based on the loop objects name.
- i. Check **Points in Alarm** to filter loop objects that contain points currently in alarm state, and then click GO button.

4. In the below Loop Objects Lists, you can sort the list by clicking the BROWSE button (see "Basic Function" section for details on filtering).

5. To edit loop object properties, click the name of the loop object in the Name column.

RESULT: The Loop Object Details dialog box displays.

Loop Object_TPC - Mozilla Firefox

192.168.255.241/standard/loopobject/frameset.php?Locale=1033&Object=503316

Loop Object Details

General Alarming **Values** References Event Enrollments

Parameters ?

Proportional Constant (Xp):

Derivative Constant (Tv): sec

Integral Constant (Tn): sec

Bias: %

Maximum Output: %

Minimum Output: %

Update Interval: msec

Action:

Reliability:

Priority for Writing ?

Value:

Status ?

In Alarm Overridden

Fault Out of Service

Change of Value ?

Increment: %

SUBMIT **CLOSE**

Refresh: 30 sec

By default, the *Value* tab is selected.

6. To edit loop object properties, do any of the following:
 - a. In **Proportional Constant (Xp)**, enter the value for the proportional band.
 - b. In **Derivative Constant (Tv)**, enter the value for the derivative time, and in **Integral Constant (Tn)**, enter the value for the integral action time.
 - c. In **Bias**, enter an offset value.
 - d. In **Maximum Output**, enter the maximum value.
 - e. In **Minimum Output**, enter the minimum value.
 - f. In **Update Interval**, **Action**, **Reliability**, and in **Value** of **Priority for Writing** the current values are displayed.
 - g. In **Status**, check the flags you want to be controlled. Note that not all flags are possible for loop objects.
 - h. Under **Change of Value**, enter the COV value in the **Increment** field.
 - i. Click **SUBMIT** to save settings, or continue with editing other details by selecting the corresponding tab, e.g. the Alarming, References, Event Enrollments, or General tab.
 - j. When selecting the Alarming tab, do any of the following:
 - k. Under **Reporting**, check/uncheck which transition type (To-OffNormal, Back To-Normal, or To Fault) will be tracked or not tracked by timestamping. Note that the reporting settings can be pre-defined in CARE, hence some transitions types may already be enabled.

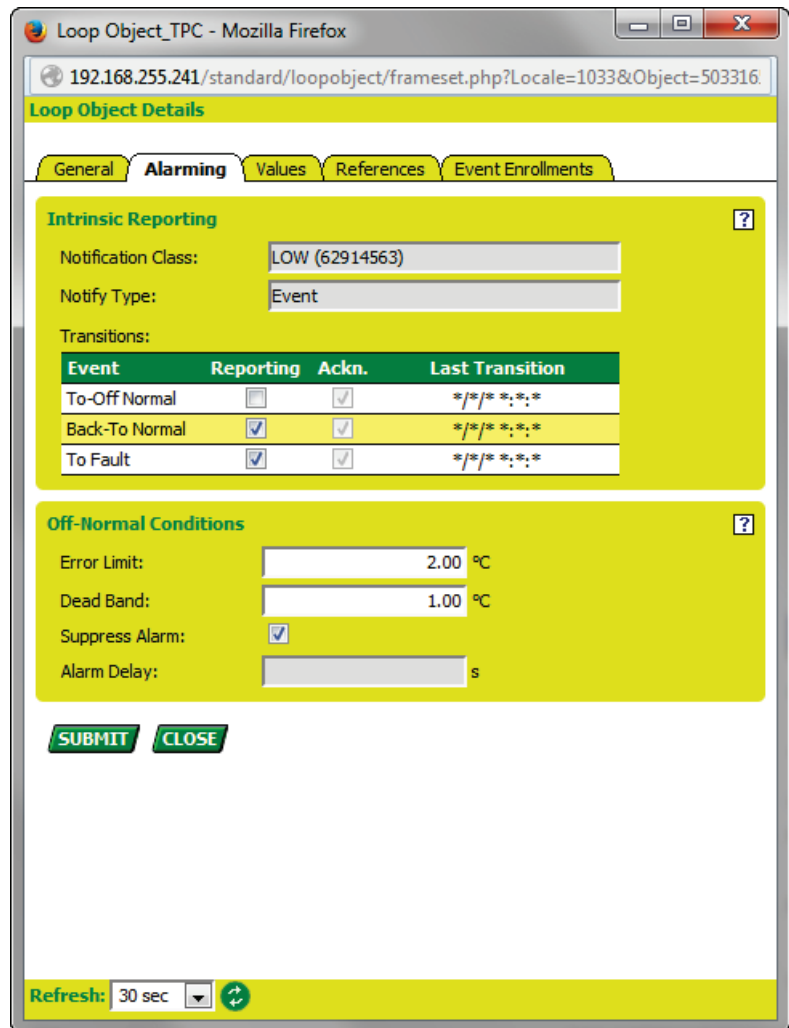

- l. In **Error Limit**, enter the absolute value for the difference between the controlled variable value and the setpoint (error) that must be exceeded before a 'To Offnormal' event is generated. Please consider the input of an alarm delay.
- m. In **Deadband**, define the value of the deadband in order to set off an alarm of event type 'To-Normal'. For this, the present value must, for at least the defined alarm delay (time), remain within the range:

$$\text{Low limit plus deadband and high limit minus deadband.}$$
- n. Check **Suppress Alarm** if alarms should not be generated. Or, uncheck **Suppress Alarm** if alarms should be generated. In case of the generation of alarms setting an alarm delay time is recommended in order to avoid alarms in case of overshoots.
- o. In **Alarm Delay**, enter an alarm delay (only enabled if Suppress Alarm is disabled).
- q. Click SUBMIT to save settings, or continue with editing other details by selecting the corresponding tab, e.g. the References, Event Enrollments, or General tab.
- r. When selecting the References tab, do any of the following:

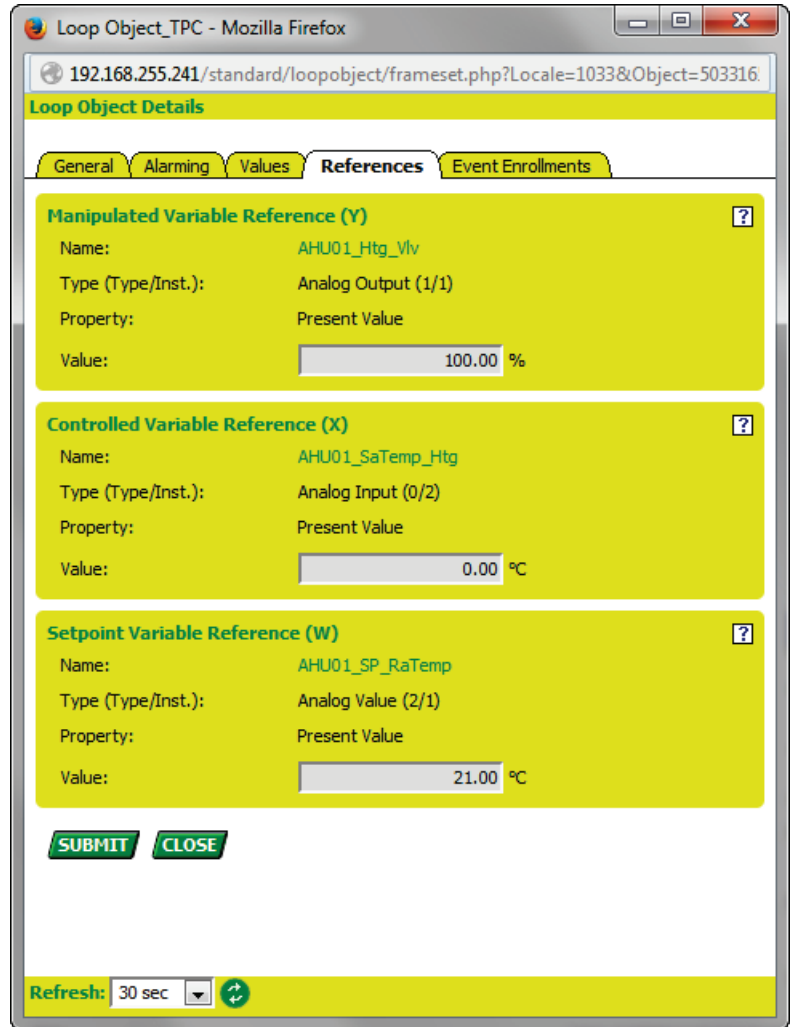

- s. View the current datapoint values of the referenced variables.
- t. If desired, click the datapoint in **Name** to edit the datapoint details of the assigned datapoint. For editing details of datapoints, please refer to the "View / Edit Datapoint Details" section.
- u. Click SUBMIT to save settings, or continue with editing other details by selecting the corresponding tab, e.g. the Event Enrollments or General tab.
- v. When selecting the Event Enrollments tab, do any of the following:

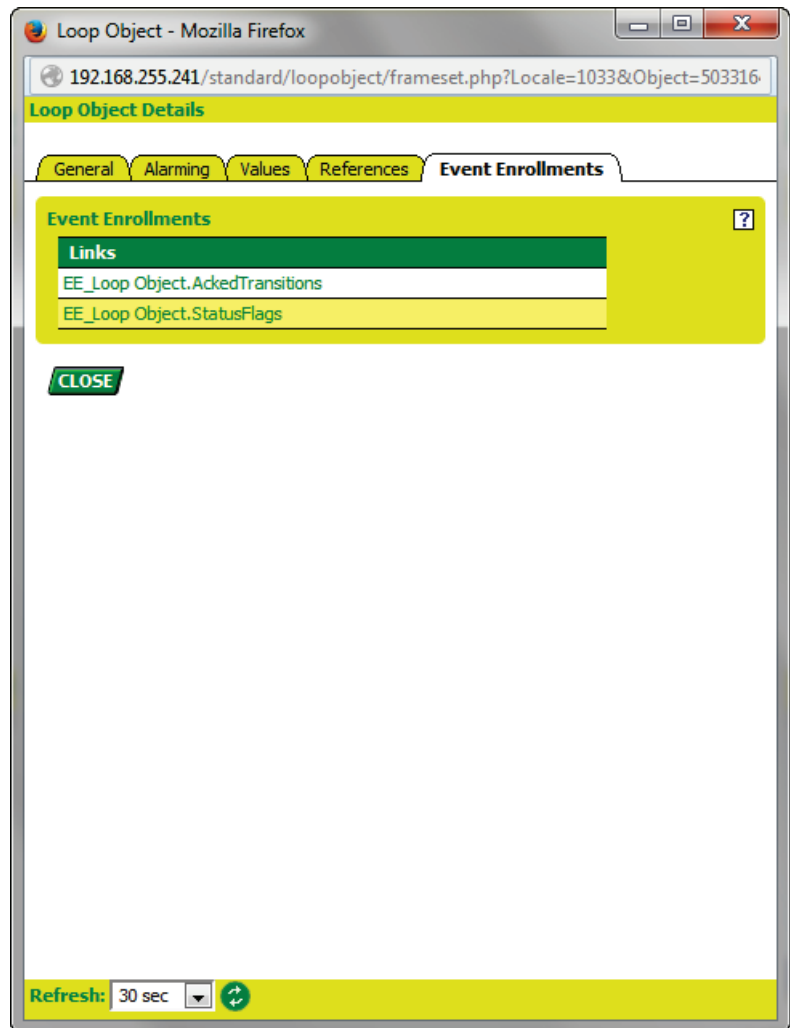

- w. In the **Links** list, click the event enrollment you want to edit. The corresponding Event Enrollment Details dialog box displays. For editing details of event enrollments, please refer to the "View / Edit Event Enrollment Alarming" section.
- x. Click SUBMIT to save settings, or continue with editing other details by selecting the corresponding tab, e.g. the General tab.
- y. When selecting the General tab, you can view the following general settings:
- Loop Object Name
 - Type
 - Description
 - Read Access Level
 - Write Access Level



z. Click SUBMIT to save settings, or click CLOSE to close the dialog box.

Enable Event Enrollment Alarming

Event enrollment alarming can be enabled for the following project parts:

Plant

See “Enable Event Enrollment Alarming for Plant” section in the following.

Controller

See “Enable Event Enrollment Alarming for Controller System Status” section in the following.

See “Enable Event Enrollment Alarming for Controller Email Alarming” section in the following.

Datapoints

See “View / Edit Event Enrollment Alarming” in the “Operating the Eagle Web Interface” section.

Enable Event Enrollment Alarming for Plant

Purpose Enable the Event Enrollment Alarming for the plant.

- Procedure** 1. In the tree, expand the *Advanced* folder, and then click on the plant.

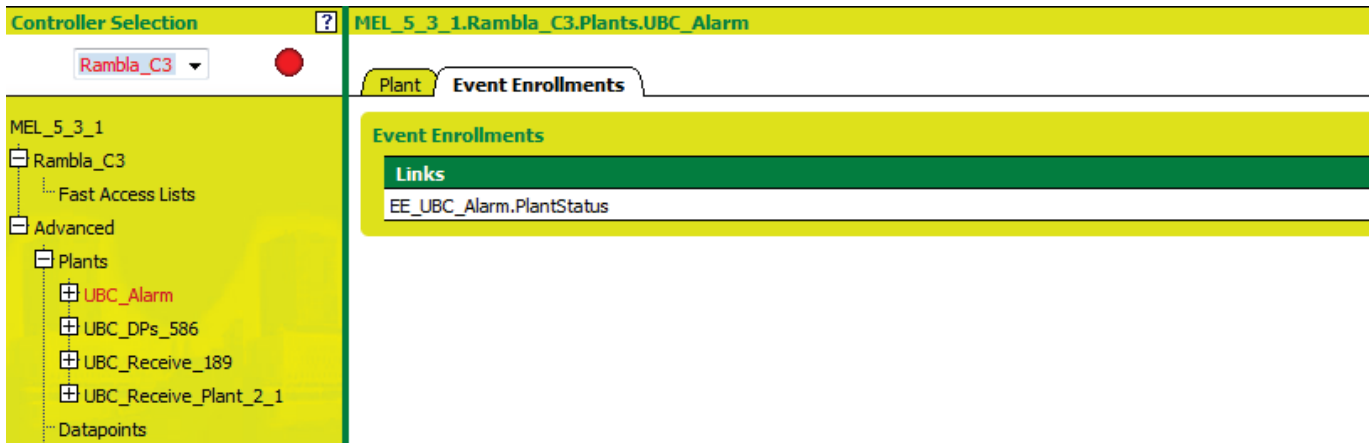

2. On the right pane, click the *Event Enrollments* tab.
 3. To enable event enrollment alarming for the plant, click the *PlantStatus* link.

RESULT: After selecting *PlantStatus* event enrollment, the *Event Enrollment Details* dialog box displays. The *Alarming* tab is selected by default. Here the following algorithmic reporting settings defined in CARE are displayed:

- Notification Class
- Notify Type
- Event State
- Transitions (Acknowledged status and time and date of last transition)
- Event Type
- BACnet Property State
- Program State(s) (=Off-Normal-States)

You only can select the transitions to be reported and set the delay time.

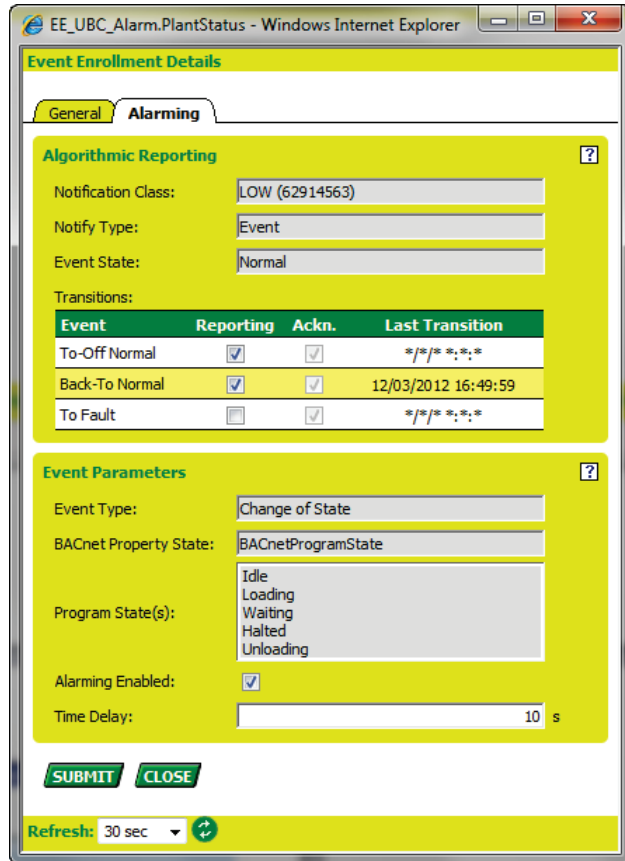

- Under **Transitions**, check the transition events that should trigger the event enrollment alarming. Refer to the relevant To-Off-Normal transitions listed under **Program State(s)**.

Example: When selecting 'To-Off-Normal', each transition from 'RUNNING' (Normal State) to any of the Off-Normal States, for example 'HALTED', will cause an event enrollment alarm.

- In the **Time Delay** field, enter a time delay in sec. The event enrollment alarm will be sent after the time entered here, has been elapsed.
- Click SUBMIT button.
- To view general event enrollment properties, click the *General* tab. Here the following properties set in CARE are shown:
 - Object Type
 - Description
 - Read Access Level
 - Write Access Level

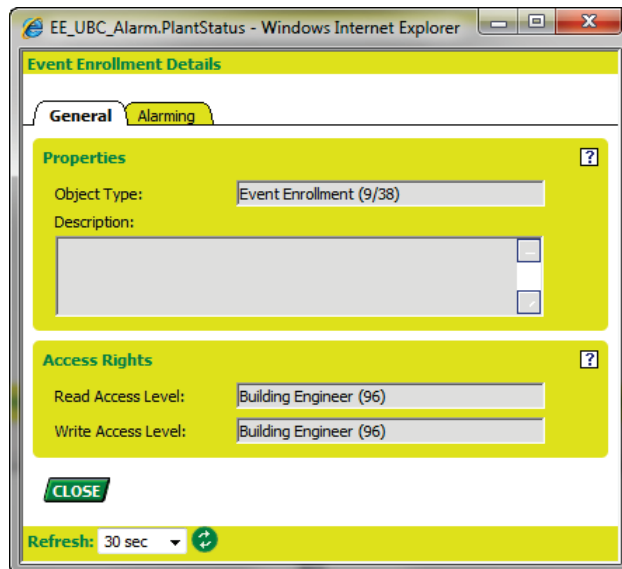

8. Click CLOSE button.

Enable Event Enrollment Alarming for Controller System Status

Purpose Enable the Event Enrollment Alarming for the controller’s system status.

- Procedure**
1. In the tree, click on the controller.
 2. On the right pane, click the *Event Enrollments* tab.

RESULT: On the *Event Enrollments* tab, you can select event enrollments to enable the system status alarming and the Email alarming:

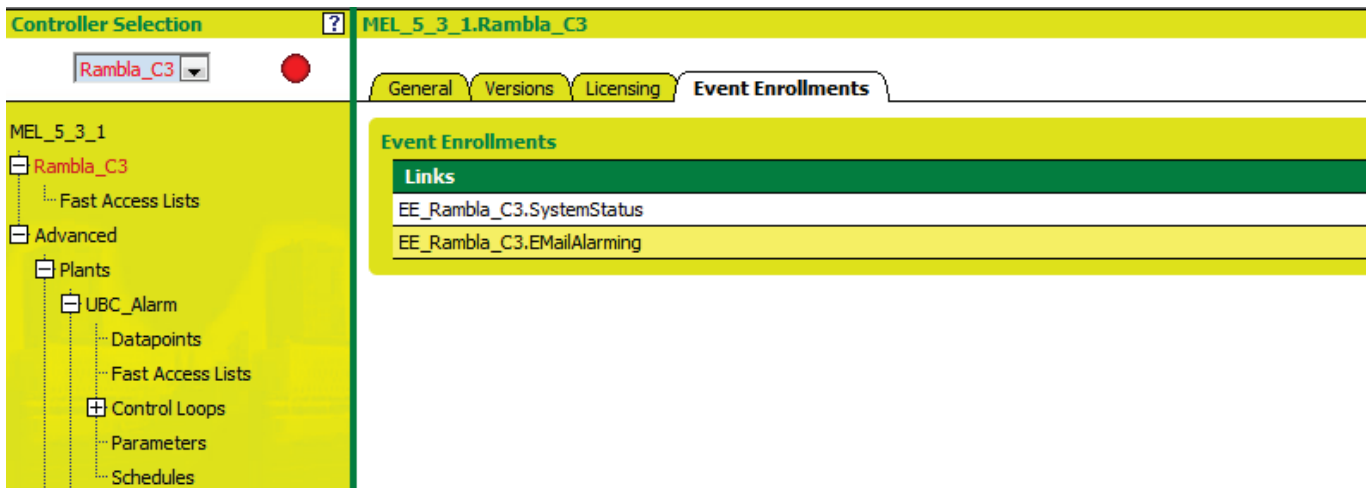

3. To enable event enrollment alarming for the controller’s system status, click the *SystemStatus* link. To enable event enrollment alarming for the controller’s email alarming, see “Enable Event Enrollment Alarming for Controller Email Alarming” section.

RESULT: After selecting the *System Status* event enrollment, the *Event Enrollment Details* dialog box displays. The *Alarming* tab is selected by default. Here the following algorithmic reporting settings defined in CARE are displayed:

- Notification Class
- Notify Type
- Event State
- Transitions (Acknowledged status and time and date of last transition)
- Event Type
- BACnet Property State
- BACnet Device State(s) (=Off-Normal-States)

You only can select the transitions to be reported and set the delay time.

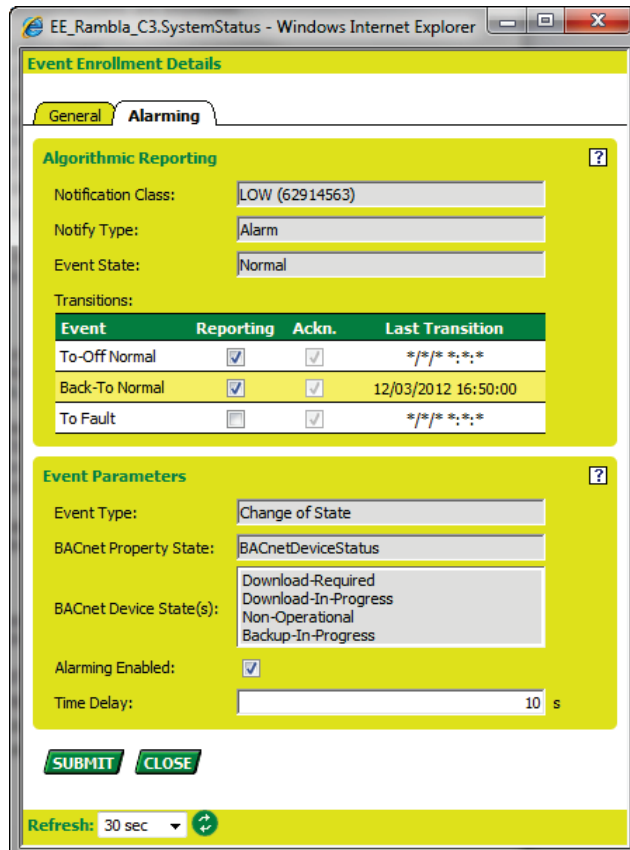

4. Under **Transitions**, check the transition events that should trigger the event enrollment alarming. Refer to the relevant To-Off-Normal transitions listed under **BACnet Device State(s)**.

Example: When selecting 'To-Off-Normal', each transition from 'OPERATIONAL' (Normal State) to any of the Off-Normal States, for example 'DOWNLOAD REQUIRED', will cause an event enrollment alarm.

5. In the **Time delay** field, enter a time delay in sec. The event enrollment alarm will be sent after the time entered here, has been elapsed.
6. Click SUBMIT button.
7. To view general event enrollment properties, click the *General* tab. Here the following properties set in CARE are shown:

- Object Type
- Description
- Read Access Level

- Write Access Level

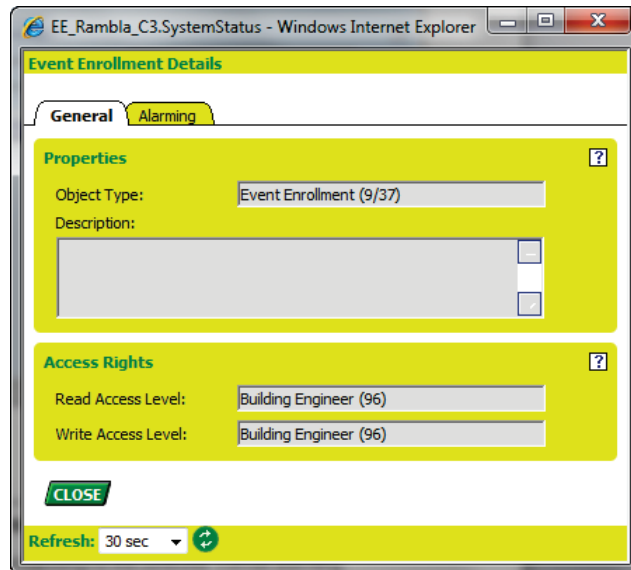

8. Click CLOSE button.

Enable Event Enrollment Alarming for Controller Email Alarming

Purpose Enable the Event Enrollment Alarming for the controller’s email alarming.

- Procedure**
1. In the tree, click on the controller.
 2. On the right pane, click the *Event Enrollments* tab.

RESULT: On the *Event Enrollments* tab, you can select event enrollments to enable the controller’s system status alarming and the alarming of the controller’s Email alarming:

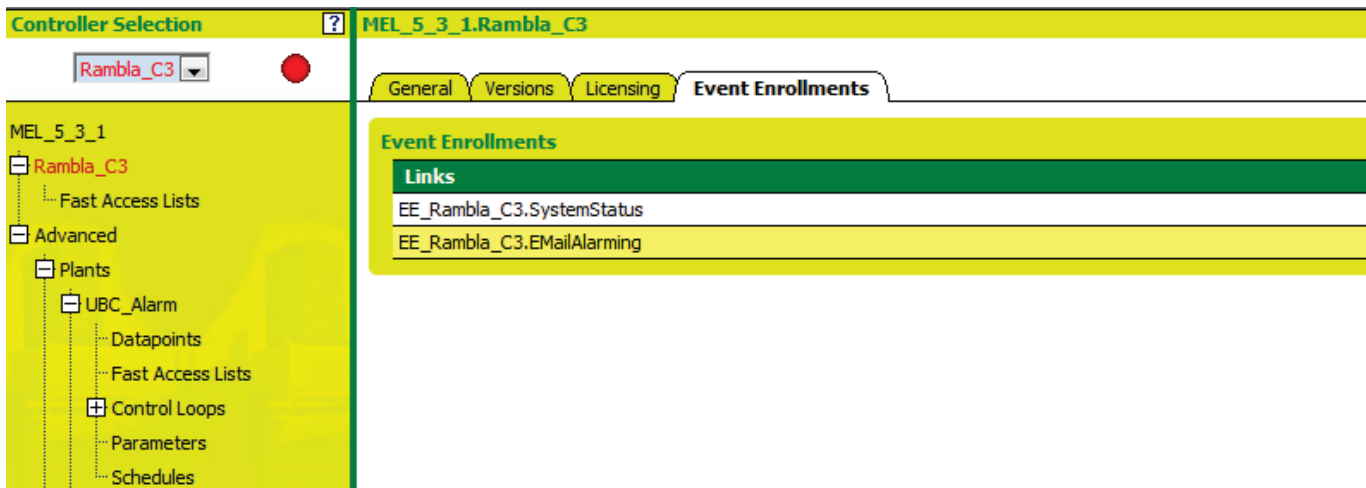

3. To enable event enrollment alarming for the controllers email alarming, click the *EmailAlarming* link. To enable event enrollment alarming for the controller’s system status, see “Enable Event Enrollment Alarming for Controller System Status” section.

RESULT: After selecting the *System Status* event enrollment, the *Event Enrollment Details* dialog box displays. The *Alarming* tab is selected by default. Here the following algorithmic reporting

settings defined in CARE are displayed:

- Notification Class
- Notify Type
- Event State
- Transitions (Acknowledged status and time and date of last transition)
- Event Type
- BACnet Property State
- BACnet Device State(s) (=Off-Normal-States)

You only can select the transitions to be reported and set the delay time.

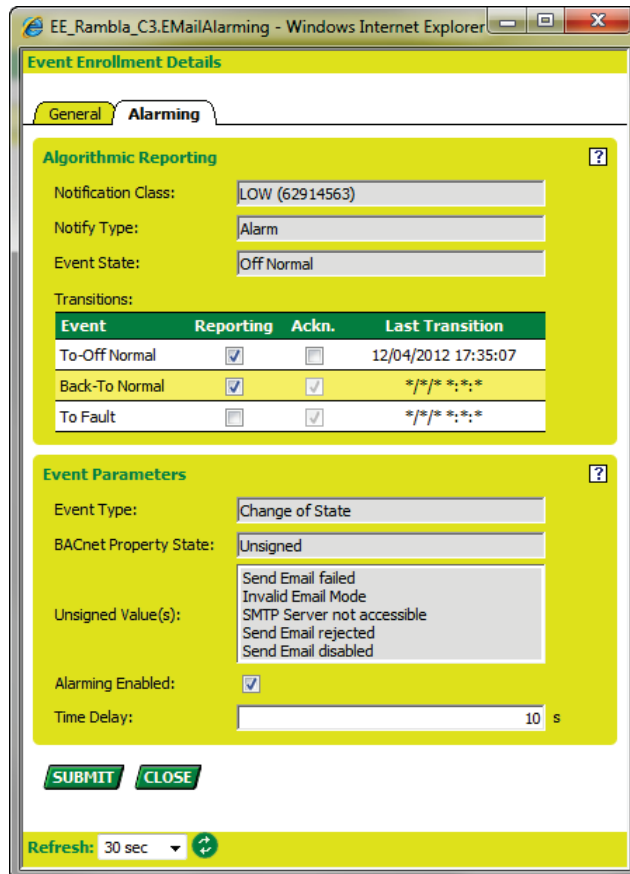

4. Under **Transitions**, check the transition events that should trigger the event enrollment alarming. Refer to the relevant To-Off-Normal transition listed under **BACnet Device State(s)**.

Example: When selecting 'To-Off-Normal', each transition from 'EMAIL_INPROCESS' (Normal State) to any of the Off-Normal States, for example 'EMAIL_FAILED', will cause an event enrollment alarm.

5. In the **Time delay** field, enter a time delay in sec. The event enrollment alarm will be sent after the time entered here, has been elapsed.
6. Click SUBMIT button.
7. To view general event enrollment properties, click the *General* tab. Here the following properties set in CARE are shown:

- Object Type

- Description
- Read Access Level
- Write Access Level

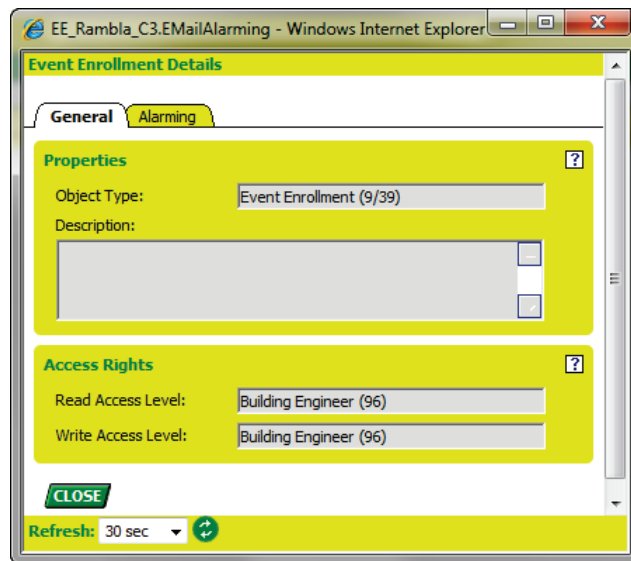

8. Click CLOSE button.

Email Alarming

Sending an alarm per email to a recipient is triggered by the notification class defined for the datapoint.

Email addresses must be assigned to users (recipients) that should receive the corresponding alarm emails and to notification classes.

Email assignments can be done in CARE and in the Web Interface.

Prerequisites

With CARE, the controller settings including the email settings must have been downloaded into the controller. The application must be running.

Procedure

1. In the tree, expand the *Advanced* item and click on **User Administration**.

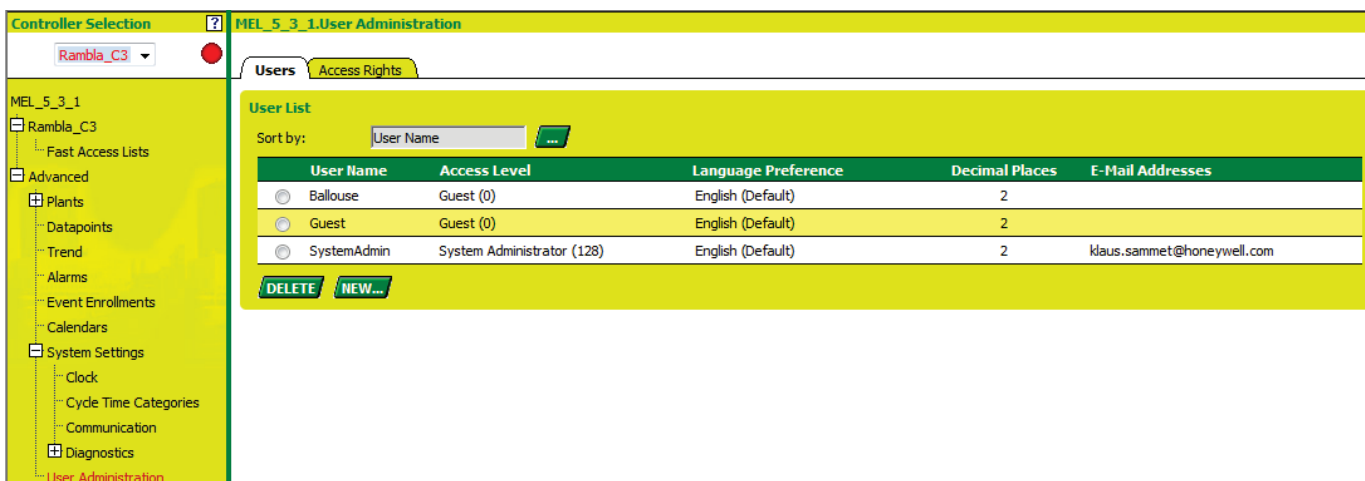

2. On the right, click the *User* tab, and then click the user in the list.

RESULT: The *New / Edit User Profile* dialog box displays.



3. Click **Edit** button.

RESULT: The *New Address Entry* dialog box displays.

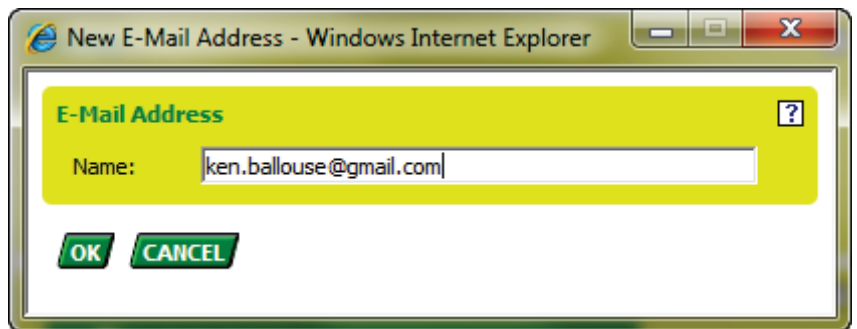

4. In the **Name** field, enter the email address, and then click OK.

RESULT: The *New User Profile* dialog box redisplay. The email address is added under **E-Mail Address**.



5. Click OK.

RESULT: On the *User* tab, the email address is assigned to the user as displayed in the **E-Mail Address** column of the selected user.

6. In the tree, expand the *Advanced* item and click on Alarms.

7. On the right pane, click the *E-Mail Address Assignment* tab.

Users Access Rights

User List

Sort by:

User Name	Access Level	Language Preference	Decimal Places	E-Mail Addresses
<input checked="" type="radio"/> Ballouse	Guest (0)	English (Default)	2	ken.ballouse@gmail.com
<input type="radio"/> Guest	Guest (0)	English (Default)	2	
<input type="radio"/> SystemAdmin	System Administrator (128)	English (Default)	2	klaus.sammet@honeywell.com

DELETE **NEW...**

- Click the notification class that you want to apply for sending the email alarm, for example, URGENT.

RESULT: The *New / Edit E-Mail Address Assignment* dialog box displays.

EAGLE CENTRAL LINE
by Honeywell

Controller Selection: MEL_5_3_1.Rambla_C3.Alarms

Rambla_C3

Alarm Buffer | E-Mail Alarming | **E-Mail Address Assignment**

MEL_5_3_1

- Rambla_C3
 - Fast Access Lists
 - Plants
 - Datapoints
 - Trend
 - Alarms**
 - Event Enrollments
 - Calendars
 - System Settings
 - Clock
 - Cycle Time Categories
 - Communication
 - Diagnostics
 - User Administration

Assign E-Mail Addresses Entries per Page: 10

Notification Class	E-Mail Address	From Time	To Time	Mo	Tu	We	Th	Fr	Sa	Su	To-Off	Normal	Back To-Normal	To Fault
HIGH				-- No Entry --										
JOURNAL	klaus.sammet@honeywell.com	00:00	00:00	<input checked="" type="checkbox"/>	<input checked="" type="checkbox"/>	<input checked="" type="checkbox"/>	<input checked="" type="checkbox"/>	<input checked="" type="checkbox"/>	<input checked="" type="checkbox"/>	<input checked="" type="checkbox"/>	<input type="checkbox"/>	<input type="checkbox"/>	<input type="checkbox"/>	<input type="checkbox"/>
LOW				-- No Entry --										
URGENT				-- No Entry --										

Page: < | 1 | >

- In Assignable Addresses, select the email address(es) you want to assign to the notification class.
- Click the Right-Arrow button.

RESULT: The E-Mail address is assigned. **Under Assigned Addresses** on the right, all email addresses assigned to the notification class are displayed. The recipients with the emails listed will receive the alarms of the selected notification class.

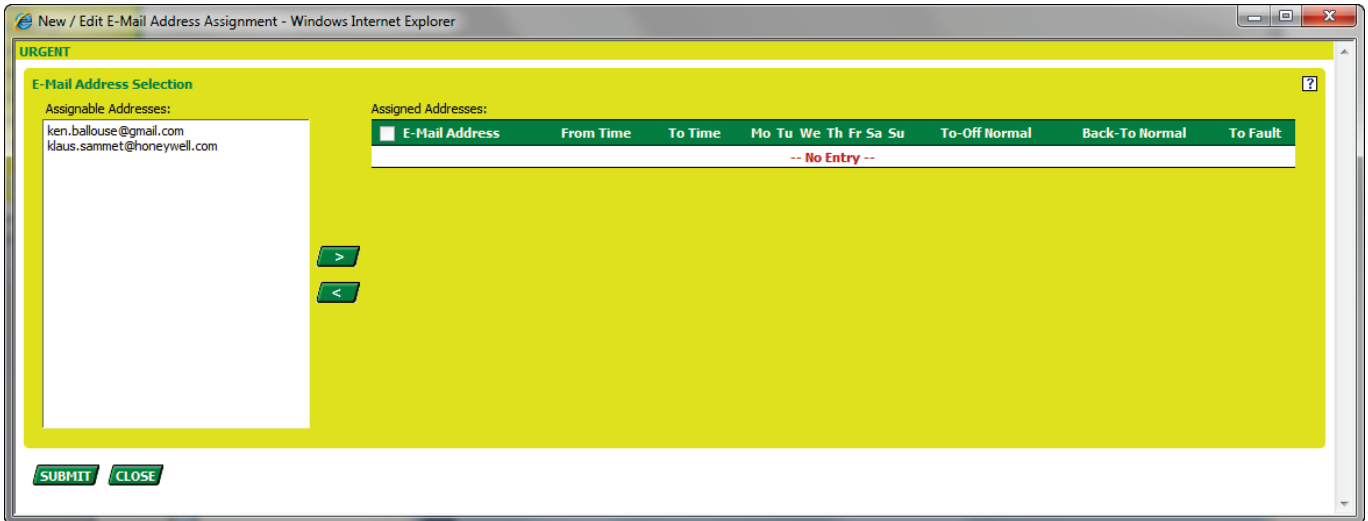

11. Choose options and enter values for the valid time period under **From Time, To Time, Mo, Tu, We, Th, Fr, Sa, Su**.
12. Check the **To-Off Normal, Back-to Normal, and/or To Fault** transitions.

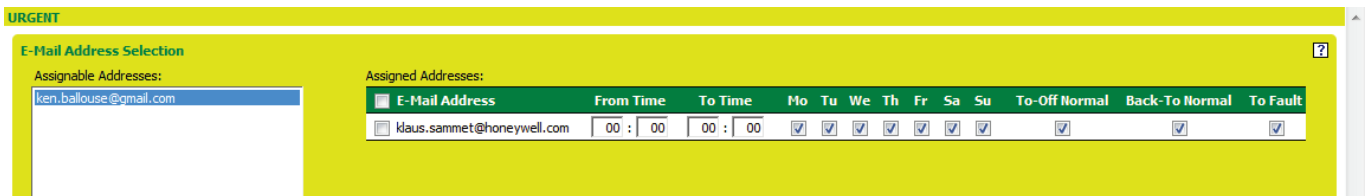

13. Click OK.

RESULT: The *E-Mail Address Assignment* tab redisplay. For the edited notification class, the assigned email address and the selected options are displayed in the respective columns.

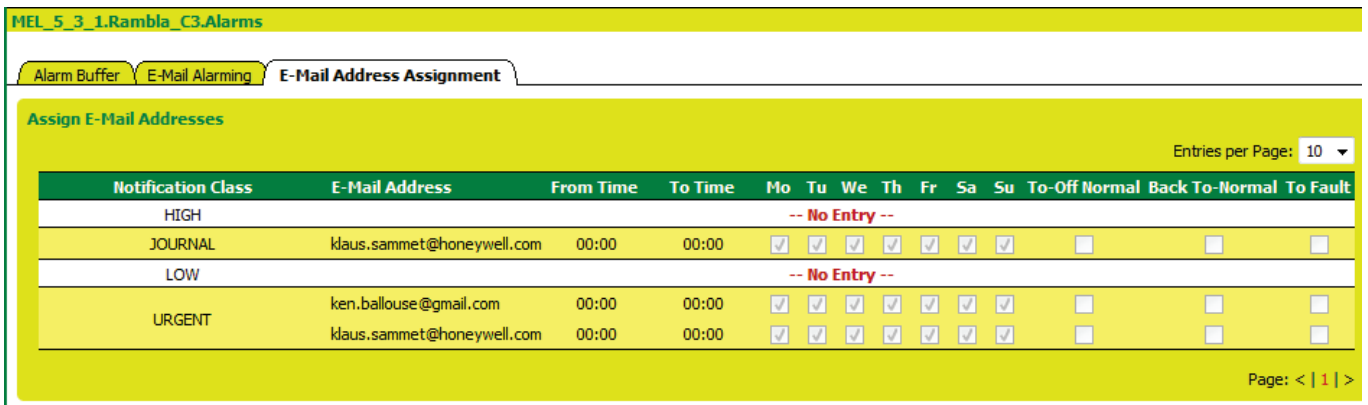

14. Click OK.
15. Expand the tree, and then click on **Communication**.
16. On the right pane, click the *E-Mail* tab.

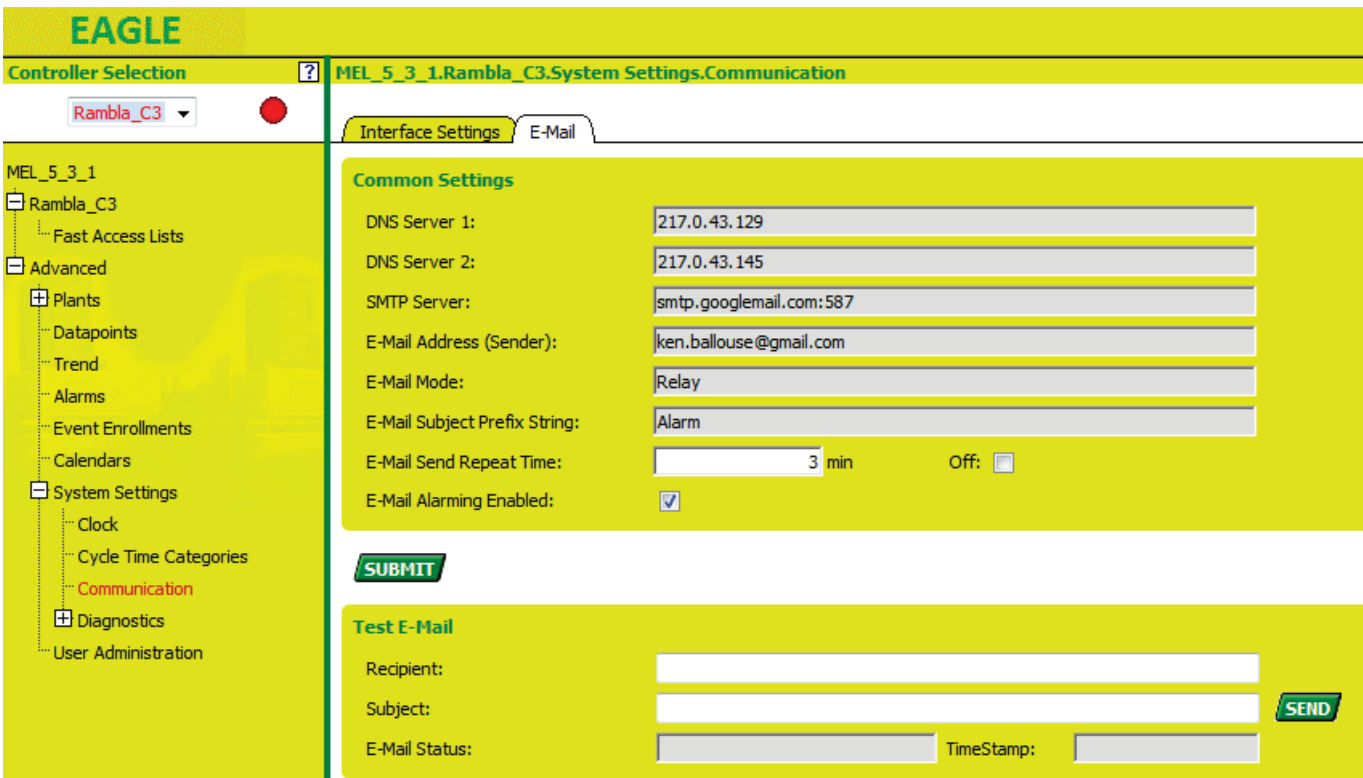

17. Under **Test E-Mail**, enter the email address of the recipient in the **Recipient** field and the subject in the **Subject** field. The recipient email address is normally the same email address you have entered as **Crash E-Mail Address** in CARE.

18. Click **Send** button.

RESULT: Under **E-Mail Status**, the sending status is shown. Note that it may take a few seconds due to the defined refresh interval of the Eagle Web Interface. If the test was successful, the email status shows 'Send Email successfully'. If the email was not sent successfully, try to find out what the error is by checking the procedure described in the previous steps. Correct the errors and perform the test again.

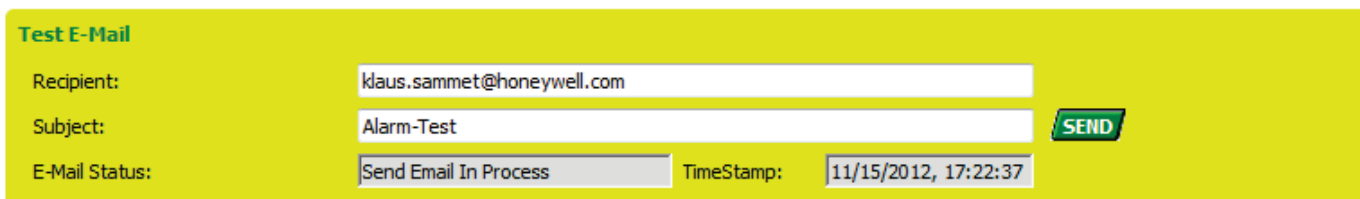

19. Check your email box for the received test email.

20. If the email test is successful, check **E-Mail Feature Enabled**.

Checking the **E-Mail Alarming Enabled** check box instantly enables the controller sending emails when alarms occur.

NOTE: When firstly setting up the email alarming function, do not check this option unless you have performed the email test. It is recommended to check this option only when you are sure that the entered data are correct and emails will be sent to the right recipient, by using the existing and already tested 'email send path'.

Example:

Reuse of the established email send path after application modifications and subsequent application download

21. On the *E-Mail* tab, change the **E-Mail Send Repeat Time (Minutes)** if desired. After the time interval in minutes, entered here, the email is repeatedly sent to the recipient. Check the **Off** checkbox, if you want to turn off the repeated sending of emails, for example when using the Test E-Mail function. Turning off the option may result in the loss of particular emails if the first attempt of sending the email has failed.
22. In the tree, click **Alarms**, and then click *E-Mail Alarming* tab on the right to view the email transmission result. Under **Last E-Mail Transmission Result**, the following data are shown:

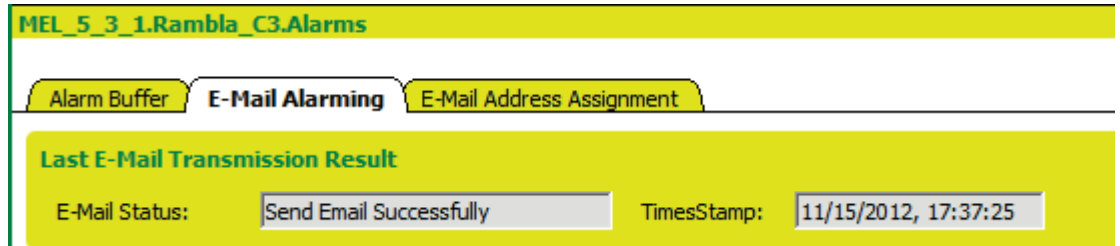

E-Mail Status
Shows the status of the last sent email, for example 'Send Email Successfully' or 'Send Email Status Not Available'.

TimeStamp
Shows the date and time of the last email status.

Under **E-Mail Alarm Send Queue**, emails are listed which, for some reason, have not been sent yet. The emails are shown with the following properties:

- To(Recipient)
Shows email address
- Subject
Shows <Alarm><datapoint name>
- Timestamp
- Total Alarms in E-Mail
Shows the number of alarms included in the email
- Notification Class
Shows the notification class

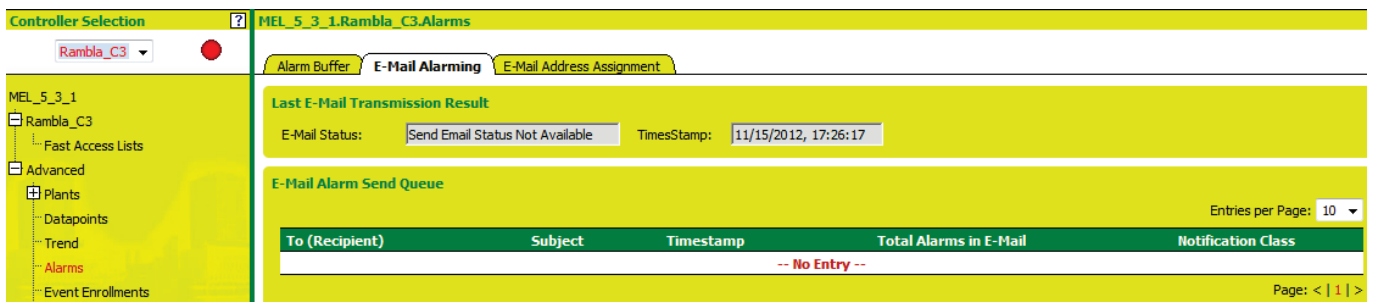

XWADMIN.INI FILE ENTRIES

The *XWADMIN.INI* file of EAGLE firmware 2.02.02 and newer contains various entries which can be used for troubleshooting. The file is located in the */usr/local/etc/* folder and inactive by default.

Ignore Remote Devices

In large BACnet systems with FALCON controllers and MS/TP devices, FALCON controllers can harm the MS/TP devices because each FALCON controller adds all BACnet devices to his device list. To avoid this, the option 'Ignore Remote Devices' can be applied in order not to import the information of remote devices that reside in channels such as MS/TP or BACnet over LON.

Default: BACnetConnection: IgnoreRemoteDevices=0

- 0 = add remote devices
- 1 = ignore remote devices

The active setting can be checked by collecting the diagnosis files using the FTP diagnosis tool. If remote devices are ignored, the file 'BACnetDevList' should not contain MS/TP devices.

NOTE: If the entry 'IgnoreRemoteDevices' has been changed, the controller must be restarted in order to apply the changes.

AUTOMATIC SAVING OF ONLINE CHANGES

Online changes done via the Eagle Web Interface or via the BACnet client like the BACnet client will be automatically saved every 80 seconds to the non-volatile onboard Flash memory in the Eagle controller. The save cycle is not done more often in order to protect the lifetime of the Flash memory. Changes of the control loop parameters or datapoint properties initiated by the control loops are stored in intervals of 24 hours.

Eagle Controller and Communication Failures

In case of communication failures, the Eagle controller behaves as follows:

Operating system is stopped

- The watchdog causes a restart of the controller. On the physical controller this is not visible. In the Eagle Web Interface this is indicated by the interrupted browser access.
- BACnet client indicates 'Controller Offline'
- If a restart of the controller fails, the watchdog relay blocks. If the binary output is used as alarm connector, the connected device gives a visual or acoustic alarm.
- BACnet client indicates 'Controller Offline'

Voltage drop

- Restart of the controller.
On the physical controller this is not visible.
- BACnet client indicates 'Controller Offline'.

Network cable damaged

- Link LED on the controller is OFF (depending on failure).
- BACnet client indicates 'Controller Offline' during the time of power failure and controller restart.

LON bus not accessible, LON cable break, or LON node not available

Identifying LON communication failures must be done in the application, for example, by using one datapoint of the module that represents the LON module.

The datapoint must be handled as follows:

- General: assign alarm text
- For inputs: activate heartbeat
- For outputs: set acknowledged service

The datapoint alarm created due to the LON failure is displayed in the BACnet alarm list.

CONTROLLER OVERLOAD INDICATORS

The following behavior indicates an overload of the Eagle controller:

- Multiple controller restarts due to Web Interface access
- Racl execution times are close to or larger than the cycle time

Action to find Cause	Result of Action	Cause	Action to Resolve Overload
1. Stop the BACnet communication of the BACnet Client	Immediate faster Racl Execution Times	Too many ReadProperty / ReadPropertyMultiple from BACnet client	Change BACnet client's tuning parameter: Sample period to use COV / RPM to force more COVs and less RPMs
	Execution time slowly decreasing	Too many COV Notifications	Increase COV Hysteresis Change BACnet client's tuning parameter: Sample period to use COV / RPM to force less COVs and more RPMs
	Execution time not decreasing	Unknown Continue with action 2.	
2. Unplug Ethernet	Execution time decreasing	Load comes from COV of point references	Increase COV Hysteresis of point
	Execution time not decreasing		Application too big for required cycle time -> increase cycle time.

CONTROLLER BOOT AND WATCHDOG BEHAVIOR

The EAGLE firmware includes the following components:

- Linux
- XW System
- XW Main

The following describes the controller boot and watchdog behavior process.

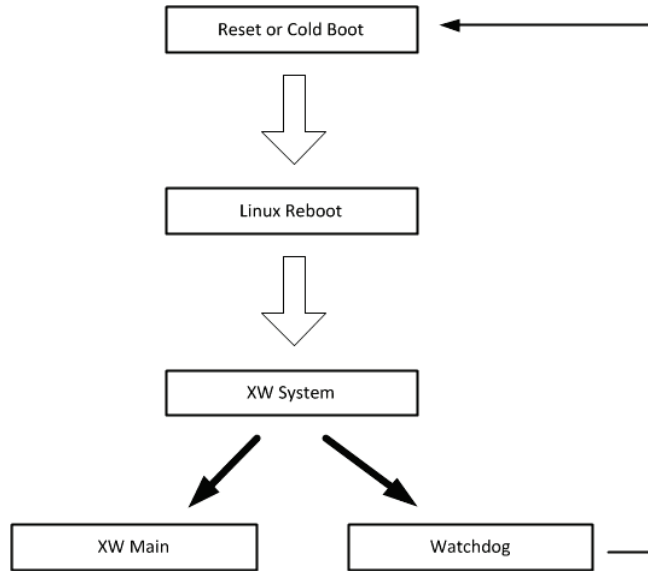

XW System The XW system has the following functions:

- Controls the XW Main process
- Communicates with CARE (Date/Time and IP settings)
- Triggers watchdog every sec.

If the watchdog is not triggered within 20 sec, a cold boot will happen.

NOTES:

The watchdog does not "supervise" the CARE application, it "supervises" the Operating System of the Eagle controller.

Controller Restart

NOTE: A controller restart (power-cycle or re-boot) will stop logging and will erase all logging data, since logging data is only stored temporarily ("temp" folder) in order to avoid endless logging and accumulation of huge log files.

TROUBLESHOOTING

For troubleshooting, please access the Honeywell Technical Assistance Center Europe at:

<http://web.ge51.honeywell.de/tac>

#

#States

- datapoint property description, 55

A

Above high limit

- event state, 175, 186

Access level

- see user level, 20
- select for existing user, 128
- select for new user, 125

Access level display

- user administration, 122

Access modes

- Eagle controller, 12

Access right

- select user level, 123

Access rights

- user administration, 20

Access rights list

- create, 123

Ackn.

- datapoint property description, 27

Active/inactive text

- datapoint property description, 27

Actual cycle time

- cycle times, 201

Add points in trend, 214

Alarm

- priority, 95

Alarm

- handling, 85

Alarm

- timestamp, 225

Alarm

- details, 226

Alarm

- event type, 226

Alarm

- category, 226

Alarm

- priority, 226

Alarm

- transitions, 226

Alarm

- value, 226

Alarm

- status flags, 226

Alarm

- text, 226

Alarm and Event Priority Classification, 95

Alarm behavior

- datapoints, 85

Alarm behavior (diagram)

- analog input, 89
- analog output, 90
- analog value, 90

- binary input, 91

- binary output, 91

- binary value, 92

- multi-state input, 92

- multi-state value, 93

- pulse converter, 94

Alarm buffer, 87, 224

Alarm delay

- datapoint, 179

- datapoint property description, 27

Alarm delay time, 87

Alarm display, 87

- see also alarm notification, 86

Alarm filter, 225

Alarm handling

- datapoints, 85

- overview, 15

- see also alarm behavior, 85

Alarm list, 225

Alarm notification

- see also alarm display, 86

Alarm source, 225

Alarm status display

- Eagle HTML interface, 118

Alarm suppression, 87

Alarm text

- datapoint property description, 28

Alarm type

- datapoint, 178

- datapoint property description, 28

Alarm value

- datapoint property description, 28

Alarm value enable

- datapoint, 180

- datapoint property description, 29

Alarming

- datapoint, 176

- datapoint details, 176

- Event enrollment, 241

- intrinsic reporting, 178

Alarms, 85, 224

Allocate

- IP address to Eagle controller, 13

ALM (in alarm) flag, 175

Analog event states, 28

Analog input

- alarm behavior (diagram), 89

- datapoint properties, 58

- general, 23

Analog output

- alarm behavior (diagram), 90

- datapoint properties, 61

- general, 23

Analog value

- datapoint properties, 63

- general, 24

Application control

- Eagle, 15

Application files

- backup, 17

- restore, 17

- Assignable parameters
 - select for fast access list, 141
- Assignable points
 - select for fast access list, 139
- Assigned parameters
 - fast access list, 142
- Assigned points
 - fast access list, 139
- Auto
 - datapoint property description, 29
 - present value, 29, 43, 181
- Auto operation
 - datapoint, 29, 43, 181
- Automatic logout time of server
 - communication settings, 201
- Automatic logout time of web server, 100, 198
- Automatic logout time of web server
 - communication settings, 198
- Automatic operating mode, 25

B

- Back To-Normal
 - transition events, 85, 95
- Backup
 - application files, 17
- BACnet
 - statistics, 206, 208, 210
- BACnet analog value
 - use as setpoint, 183
- BACnet binary output
 - feedback value, 38, 182
- BACnet binary value
 - use as setpoint, 183
- BACnet diagnostics
 - statistics, 206, 208, 210
- BACnet ID
 - datapoint property description, 31
- BACnet instance
 - datapoint property description, 29
- BACnet IP
 - communication protocol, 14
- BACnet multi-state input
 - multi-state properties, 37, 40, 41, 42
- BACnet multi-state output
 - feedback value, 182
- BACnet multi-state value
 - use as setpoint, 183
- BACnet object type
 - datapoint property description, 30
- BACnet points
 - trend, 214
- BACnet reference input point
 - property, 48
- Basic functions
 - Excel HTML interface, 118
- Baudrate
 - communication settings, 198, 201
- Baudrate settings, 100, 198
- Below low limit
 - event state, 186
- Binary input
 - alarm behavior (diagram), 91
 - datapoint properties, 66
 - general, 23
- Binary output

- alarm behavior (diagram), 91
- general, 23
- Binary value
 - alarm behavior (diagram), 92
 - general, 24
- Boot
 - controller, 257
- Building engineer
 - user level, 123

C

- Date range, 167
- Specific date, 167
- Calendar
 - copy, 165, 169
 - create, 165, 166
 - date entry, 167
 - date range, 167
 - delete, 165, 173
 - description, 167
 - edit, 170
 - information, 167
 - list of dates, 167
 - read/write access level, 167
 - recurring event, 167
 - show references, 165, 173
 - specific date, 167
 - valid period of date entry, 167
- Calendar name
 - enter, 167
- Calendar reference
 - exception, 163
 - validity type, 163
- Calendars, 98
 - general, 165
 - invoke, 165, 169, 170, 173, 214
 - overview, 16
 - view, 165
- Categories
 - cycle times, 201
- Alarm, 225
- Category
 - alarm, 225, 226
- Central
 - communication settings, 198, 201
- Central Compatibility, 15
- Certificates, 103, 104, 213
- Change
 - parameter, 233
- Change of state
 - event type, 87
- Change of state count
 - datapoint property description, 52
- Change of value
 - datapoint property description, 40
- Change of value (COV), 40
 - datapoint, 186
- Change parameter
 - fast access list, 144
- Character set
 - project information, 130
- Characteristic
 - datapoint property description, 32
- Client interface settings, 100, 198
- Clock

- date, time and time zone, 198
- daylight saving changes, 200
- Command failure
 - event type, 87
- Command priorities
 - datapoint, 176
 - datapoint details, 176
- Common settings
 - email, 202
- Communication
 - system settings, 198, 201
- Communication failures, 255
- Communication protocols, 14
- Clock, 198
- Dialout parameter, 201
- Re-dial algorithm, 201
- Communication settings, 100, 198, 201
 - automatic logout time of webserver, 198, 201
 - baudrate, 198, 201
 - central, 198, 201
 - clock, 198
 - dialout parameter, 201
 - interface, 198, 201
 - IP address, 198, 201
 - neuron chip ID, 198, 201
 - password, 100, 198
 - password definition, 198, 201
 - re-dial algorithm, 201
 - remote central, 198, 201
 - serial port, 198, 201
 - user name, 100, 198
 - user name definition, 198, 201
- Connection
 - physically establish to Eagle controller, 12
- Context sensitive help
 - Eagle HTML Interface, 118
- Control loop
 - cycle information, 229
 - read/write access level, 229
- Control loops, 99, 229
- Controller
 - firmware version, 133, 134
 - Linux image version, 133, 134
 - model version, 133, 134
 - restart, 257
 - version data, 133, 134
 - web pages version, 133, 134
 - web server version, 133, 134
- Controller boot and watchdog behavior, 257
- Controller Email Alarming
 - Event enrollment alarming, 246
- Controller failures, 255
- Controller information
 - controller name, 131
 - description, 131
 - device ID, 131
 - display, 130
 - ethernet settings, 132
 - location, 131
 - LON bus settings, 132
 - system status, 131
- Controller name
 - controller information, 131
- Controller overload indicators, 256
- Copy
 - calendar, 165, 169

- Copy Mode
 - switchpoints, 160
- COV
 - see change of value, 186
 - see Change of value, 40
- COV period
 - datapoint property description, 32
- Create
 - access rights list, 123
 - calendar, 165, 166
 - email address, 124, 126
 - fast access list, 137
 - schedule, 152
 - user, 122, 124
- Create loop object, 235
- Current value
 - datapoint property description, 33
- Customer
 - project information, 130
- Cycle information
 - control loop, 229
 - plant, 136
- Cycle time categories
 - system settings, 201
- Cycle time category, 100
 - system settings, 198
- Cycle time category, 201
- Cycle times
 - actual cycle time, 201
 - categories, 201
 - target cycle time, 200

D

- Data saving
 - Eagle HTML interface, 119
- Data updating
 - Eagle HTML interface, 118, 121
- Status flags, 185
- Datapoint
 - acknowledged transtions observation (event enrollment), 191
 - active state (trend), 215
 - alarm delay, 179
 - alarm type, 178
 - alarm value enable, 180
 - auto operation, 29, 43
 - change of value (COV), 186
 - deadband, 179
 - description, 177
 - edit alarming, 178
 - edit relinquish default, 186
 - edit values**, 181
 - Elapsed Active Time / Count Limits Observation (event enrollment), 195
 - enabled (trend), 215
 - EOH/EOV optimization, 184
 - event reporting, 178
 - event state, 185
 - event states (alarm behavior), 37
 - high limit enable, 179
 - intrinsic reporting, 178
 - is alarm condition, 180
 - is fault condition, 180
 - LON mapping, 177
 - low limit enable, 179

- manual life safety, 183
- manual operation, 29, 43, 181
- manual override, 43, 181
- mapped, 25
- mapping, 25
- notification class, 178
- off-normal conditions, 178
- operating mode, 25
- polarity, 183
- present value observation (event enrollment), 188
- properties, 25
- property (trend), 215
- read/write access level, 177
- refreshing, 25
- reliability, 50, 182
- role, 177
- runtime counter, 185
- status flag observation (event enrollment), 193
- status flags, 185
- status flags, 86
- transition events, 85
- transitions, 178
- trend changes, 216
- type, 177
- view alarming, 178
- view command priorities, 186
- view values**, 181
- view/edit event enrollment, 188
- Datapoint (PC)
 - period, 186
- Datapoint details
 - alarming, 176
 - command priorities, 176
 - edit, 175
 - general properties, 176
 - values, 176
 - view, 175
- Datapoint filter, 154
 - schedule, 153, 154
 - trend, 214
- Datapoint list
 - view, 174
- Datapoint name
 - datapoint property description, 33
- Datapoint name, 33
- Datapoint properties
 - analog input, 58
 - analog output, 61
 - analog value, 63
 - binary input, 66
- Datapoint property
 - off-line editing, 57
 - on-line editing, 57
- Datapoint property description
 - #states, 55
 - Ackn., 27
 - Active/inactive text, 27
 - Alarm delay, 27
 - Alarm text, 28
 - alarm type, 28
 - alarm value, 28
 - alarm value enable, 29
 - Auto, 29
 - BACnet instance, 29
 - BACnet object ID, 31
 - BACnet object type, 30
 - change of state count, 52
 - Change of value, 40
 - characteristic, 32
 - COV period, 32
 - current value, 33
 - datapoint name, 33
 - deadband, 33
 - description, 34
 - device name, 135
 - Direction, 35
 - engineering unit, 35
 - EOV / EOH optimization, 35
 - event, 36
 - event enrollment, 36
 - event state, 37
 - FIO Mapping, 38
 - Fix Prio, 39
 - High limit enable, 39
 - input NV, 42
 - in alarm, 39
 - increment, 40
 - initial value, 41
 - input NV, 41
 - IO configuration, 41
 - is alarm condition, 41
 - is fault condition, 42
 - last transition, 42
 - LON mapping, 42
 - LON point, 42
 - low limit enable, 43
 - manual, 43
 - Manual life safety, 43
 - mapping, 44
 - maximum present value, 44
 - minimum present value, 44
 - multi-state properties, 37, 40, 42
 - notification class, 44
 - notify type, 45
 - NV name, 45
 - output NV, 42, 46
 - period, 46
 - polarity, 48
 - priority level, 47
 - property, 48
 - read access level, 48
 - reference, 49
 - relinquish default, 50
 - relinquish priority, 50
 - reporting, 51
 - resolution, 52
 - runtime (active time), 52
 - safety position, 52
 - safety value, 53
 - sensor offset, 54
 - state text, 55
 - time of last reset, 55
 - time of state count reset, 56
 - time to close, 54
 - time to open, 54
 - transition events, 56
 - with switches / 3 position output, 57
 - write access level, 57
- Datapoint selection
 - trend, 214
- Datapoints
 - alarm behavior, 85

- alarm handling, 85
 - general, 23
 - manual mode, 81
 - overview, 15
 - physical, 23
 - value type, 23
- Date
 - clock, 198
- Date entry
 - calendar, 167
 - valid period, 167
- Date entry (calendar)
 - delete, 171
 - validity type, 167
- Date range
 - exception, 163
 - validity type, 163
- Daylight saving changes
 - clock, 200
- Deadband, 33
 - datapoint, 179
 - datapoint property description, 33
- Decimal places
 - select for existing, 129
 - select for new user, 125
 - user administration, 20
- Decimal places display
 - user administration, 122
- Delete
 - calendar, 165, 173
 - date entry (calendar), 171
 - fast access list, 150
 - user, 122, 129
- Delete points from trend, 214
- Description
 - calendar, 167
 - controller information, 131
 - datapoint, 177
 - datapoint property description, 34
 - enter for schedule, 156, 157
 - project information, 130
 - Property, 34
- Destination weekday(s), 160
- Details
 - alarm, 226
 - schedule, 156, 157
 - trend, 216
- Device ID
 - controller information, 131
- Device name
 - datapoint property description, 135
- Diagnostics
 - BACnet, 206, 208, 210
 - LON, 204
 - LON, 100
 - modbus, 210, 211
 - panel bus, 207
- Digital event states, 28
- Direction
 - datapoint property description, 35
- Display
 - alarm, 86, 87
 - controller information, 130
 - plant information, 135
 - project information, 129
- Display settings

- parameters, 231
- Drill down view
 - parameters, 231

E

- Eagle
 - application control, 15
 - networking, 13
 - operator interface, 12
 - programming, 15
- Eagle controller
 - access modes, 12
 - allocate IP address, 13
 - establish physical connection, 12
 - LAN connection, 12
 - see also* Eagle, 11
 - system overview, 11
 - USB connection, 13
- Eagle HTML interface
 - alarm status display, 118
 - Alarms, 224
 - basic functions, 118
 - calendarsser, 165
 - Control loops, 229
 - datapoints, 174
 - entries per page, 121
 - fast access lists, 137
 - footer description, 117
 - information and editing pane, 115
 - invoke context sensitive help, 118
 - invoke online help, 118
 - language selection, 117
 - list display, 121
 - login, 103
 - logout, 117
 - main screen description, 114
 - refresh, 117
 - refreshing data, 118
 - saving data, 119
 - schedules, 151
 - start, 103
 - tree navigation, 116
 - Trend, 214
 - updating data, 118, 121
 - user administration, 122, 135
 - viewing/editing information, 116
- Eagle HTML Interface
 - general, 19
- Edit
 - alarming of datapoint, 178
 - calendar, 170
 - datapoint details, 175
 - relinquish default of datapoint, 186
 - user, 122, 127
 - values of datapoint**, 181
- Editing information
 - Eagle HTML interface, 116
- Email
 - common settings, 202
 - system settings, 201
 - test, 203
- Email address
 - email alarming, 248
- Email addressr
 - create, 124, 126

- Email alarming
 - general, 101
 - procedure, 248
- Engineering unit
 - datapoint property description, 35
 - Properties, 35
- Enhanced mode
 - switched properties, 155
- Enter
 - calendar name, 167
 - schedule name, 156, 157
- Entries per page
 - Eagle HTML Interface, 121
- EOH/EOV optimization
 - datapoint, 184
- EOV / EHV optimization
 - datapoint property description, 35
- Error / Halt information
 - reason for error/halt, 136
- Error details
 - plant error, 136
- Ethernet settings
 - controller information, 132
- Event
 - datapoint property description, 36
 - priority, 95
- Event categories
 - transition relationship, 95
- Event enrollment
 - datapoint property description, 36
- Event enrollment
 - view/edit, 188
- Event enrollment
 - present value observation, 188
- Event enrollment
 - acknowledged transitions observation, 191
- Event enrollment
 - status flag observation, 193
- Event enrollment
 - Elapsed Active Time / Count Limits Observation, 195
- Event enrollment
 - alarming, 241
- Event enrollment alarming
 - Controller Email Alarming, 246
 - plant, 241
- Event handling
 - notification classes, 95
- Event reporting
 - datapoint, 178
- Event state
 - above high limit, 175, 186
 - below low limit, 186
 - datapoint, 185
 - datapoint property description, 37
 - fault, 186
 - normal (operation), 185
 - Off-Normal (condition), 186
- Event states
 - datapoint alarm behavior, 37, 85
- Event type
 - alarm, 226
 - change of state, 87
 - command failure, 87
 - out of range, 87
- Exception
 - calendar reference, 163

- create switchpoints, 162
- date range, 163
- delete switchpoints, 162
- recurring event, 163
- select priority, 162
- specific date, 163
- valid period, 163
- Exceptions
 - schedule, 161
- Execution speed category
 - see also cycle time category, 201

F

- Fast access list
 - change parameter, 144
 - configure template, 145
 - create, 137
 - define parameter filter, 140
 - define point filter, 139
 - delete, 150
 - filter template, 138
 - matching points, 145
 - modify, 147
 - read/write access level, 138
 - select assignable parameters, 141
 - select assignable points, 139
 - select assigned parameters**, 141
 - select assigned points, 139
 - select plant, 140
 - selected points list, 143
 - selected points/parameters, 138
 - summary, 147
 - view, 147
 - watch impact of changed parameter, 144
- Fast access lists
 - Eagle HTML interface, 137
- Status flag, 185
- Fault
 - event state, 186
 - status flag, 37, 86, 185
- Feedback value
 - BACnet binary output, 38, 182
 - BACnet multi-state output, 182
- Filter
 - parameter, 232
- Filter template
 - fast access list, 138
- FIO Mapping
 - datapoint property description, 38
- Firmware version
 - controller, 133, 134
- Fix Prio
 - datapoint property description, 39
- Flat view
 - parameters, 231
- FLT (fault) flag, 175
- Footer
 - Eagle HTML interface, 117
- FTP
 - communication protocol, 14

G

- General properties
 - datapoint, 176

datapoint details, 176

Guest

user level, 123

H

Halt details

plant halt, 136

High

notification class, 44

High limit enable

datapoint, 179

datapoint property description, 39

HMI Pin

new user, 125

HTTP

communication protocol, 14

HTTPS, 103, 104, 213

I

I/O initialization, 79

Ignore Remote Devices, 254

Status flag, 185

In alarm

datapoint property description, 39

status flag, 37, 39

In alarm

status flag, 185

Increment

datapoint property description, 40

Information

calendar, 167

Information and editing pane

description, 115

Initial value

datapoint property description, 41

Input NV

datapoint property description, 41, 42

Interface

communication settings, 198, 201

Intrinsic reporting

criteria, 87

datapoint, 178

Intrinsic reporting

alarming, 178

Invoke

calendars, 165, 169, 170, 173, 214

IO configuration

datapoint property description

IP address

allocate to Eagle controller, 13

dommunication settings, 198, 201

IP address settings, 100, 198

Is alarm condition

datapoint property description, 41

Is alarm condition

datapoint, 180

Is fault condition

datapoint property description, 42

Is fault condition

datapoint, 180

ISO 16484-5 – ENV 13321-1, 14

J

Journal

notification class (previous usage), 86

L

LAN connection

to Eagle controller, 12

Language

Eagle HTML interface, 117

user administration, 20

Language preference display

user administration, 122

Last transition

datapoint property description

Linux image version

controller, 133, 134

List display

Eagle HTML interface, 121

List of dates

calendar, 167

Local manual override, 25

Location

controller information, 131

log

trend, 221

Login

Eagle HTML interface, 103

Logout

Eagle HTML interface, 117

LON

diagnostics, 100

statistics, 204

LON bus settings

controller information, 132

LON diagnostics

overview, 18

statistics, 204

LON mapping

datapoint, 177

datapoint property description, 42

LON point

datapoint property description, 42

LON Point Mapping, 42

LON statistics

download trend records file, 204

trend records, 204

LonTalk

communication protocol, 14

Loop Object

create, 235

Loop Objects, 235

Low

notification class, 44

Low limit enable

datapoint property description, 43

Low limit enable

datapoint, 179

M

Manual

datapoint property description, 43

Manual life safety

datapoint property description, 43

Manual Life Safety
 datapoint, 183

Manual mode
 datapoints, 81

Manual mode
 see also manual operating mode, 81

Manual operating mode, 25

Manual operation
 datapoint, 29, 43, 181

Manual override
 datapoint, 29, 43, 181
 present value, 29, 43, 181

Manual override, 25

Mapped datapoint, 25

Mapping
 datapoint property description, 44

Mapping
 datapoints, 25

Matching points
 fast access list, 145

Maximum present value
 datapoint property description, 44

Minimum present value
 datapoint property description, 44

Modbus
 statistics, 210, 211

Model version
 controller, 133, 134

Modem
 system settings, 201

Modify
 fast access list, 147

Off-Normal conditions, 180

Multi-state datapoint
 Off-Normal conditions, 180

Multi-state input
 alarm behavior (diagram), 92
 general, 23

Multi-state output
 general, 23

Multi-state properties
 BACnet multi-state input, 37, 40, 41, 42
 datapoint property description, 37, 40, 42

Multi-state value
 alarm behavior (diagram), 93
 general, 24

N

Network
 priority, 95

Networking
 Eagle, 13

Neuron chip ID
 communication settings, 198, 201

Neuron chip ID setting, 100, 198

No error detected
 reliability, 50, 182

No output
 reliability, 50, 182

No sensor
 reliability, 50, 182

Normal (operation)
 event state, 185

Notification
 alarm, 86

Notification class
 'journal' (previous usage), 86
 datapoint, 178
 datapoint property description, 44
 high, 44
 low, 44
 urgent, 44

Notification Class Manager, 95

Notification class object type
 To-Fault, 95
 To-Normal, 95
 To-Offnormal, 95

Notification class object types, 95

Notification classes
 event handling, 95

Notify type
 datapoint property description, 45

Null
 Schedule
 default value, 158
 switchpoint value, 159

NV name
 datapoint property description, 45

O

Object
 trended, 221

Off-line editing
 datapoint property, 57
 Eagle HTML Interface, 57

Off-Normal (condition)
 event state, 186

Off-Normal conditions
 datapoint, 178

On-line editing
 datapoint property, 57

On-line editing (CARE), 57

Online help
 Eagle HTML interface, 118

OOS (out of service) flag, 175

Open loop
 reliability, 50, 182

Operating mode
 datapoint, 25

Operator
 user level, 123

Operator interface
 Eagle, 12

Order number
 project information, 130

Out of range
 event type, 87

Status flag, 185

Out of service
 status flag, 87, 185

Output NV
 datapoint property description, 42, 46

Overridden
 status flag, 86

P

Pane displays
 sizing, 116

Panel bus

- statistics, 207
- Panel bus diagnostics
 - statistics, 207
- Parameter
 - change, 233
 - change in fast access list, 144
 - filter, 232
 - path, 232
 - trend, 216, 219
 - value, 234
- Parameter filter
 - define for fast access list, 140
- Parameters, 100, 230
 - display settings, 231
 - drill down view, 231
 - flat view, 231
 - general, 230
- Password
 - communication settings, 100, 198
 - user administration, 20
- Password
 - change, 122
- Password
 - select for new user, 125
- Password definition
 - communication settings, 198, 201
- Path
 - parameter, 232
- Period
 - datapoint (PC), 186
 - datapoint property description, 46
- Physical datapoints, 23
- Plant
 - cycle information, 136
 - Event enrollment alarming, 241
 - program state, 136
 - restart, 136
 - select for fast access list, 140
 - shutdown, 136
- Plant description
 - plant information, 136
- Plant information
 - display, 135
 - plan description, 136
 - plant name, 136
 - plant type, 136
- Plant name
 - plant information, 136
- Plant type
 - plant information, 136
- Plants, 99
- Point filter
 - define for fast access list, 139
- Points in trend, 215
- Polarity
 - datapoint, 183
 - datapoint property description, 48
- Preferred language
 - select for existing user, 129
 - select for new user, 125
- Present value
 - Auto, 181
 - Auto, 29, 43
 - manual override, 29, 43, 181
- Priority
 - alarm, 95

- event, 95
 - network, 95
- Priority
 - switchpoints, 162
- Priority
 - switchpoints, 162
- Priority
 - alarm, 226
- Priority array, 47
- Priority for Writing
 - schedule, 156, 157
- Priority level
 - datapoint property description, 47
- Program state
 - plant, 136
- Programming
 - Eagle, 15
- Project admin
 - user level, 123
- Project administrator
 - project information, 130
- Project Information
 - character set, 130
 - customer, 130
 - description, 130
 - display, 129
 - order number, 130
 - project administrator, 130
 - project name, 130
 - reference number, 130
 - units of measurement, 130
- Project name
 - project information, 130
- Properties
 - datapoint, 25
 - Engineering Unit, 35
- Properties descriptions, 26
- Property
 - BACnet reference input point, 48
 - datapoint property description, 48
 - Description, 34
 - trended, 221
- Property selection
 - schedule, 153
- Protocolling, 17
- Pulse converter
 - alarm behavior (diagram), 94

R

- Read access level
 - datapoint property description, 48
- Read/write access level
 - calendar, 167
 - control loop, 229
 - datapoint, 177
 - fast access list, 138
 - schedule, 156, 157
 - trend, 221
- Recurring event
 - calendar, 167
 - exception, 163
 - validity type, 163
- Reference
 - datapoint property description, 49
- Reference datapoint

- general, 24
 - Reference input, 49
 - Reference number
 - project information, 130
 - References
 - calendar, 165, 173
 - Refresh
 - Eagle HTML interface, 117
 - Refreshing
 - datapoint, 25
 - Refreshing data
 - Eagle HTML interface, 118
 - Reliability
 - datapoint, 50, 182
 - no error detected, 50, 182
 - no output, 50, 182
 - no sensor, 50, 182
 - open loop, 50, 182
 - unreliable other, 50, 182
 - Relinquish default, 50
 - Relinquish default
 - datapoint property description, 50
 - Relinquish priority
 - datapoint property description, 50
 - Remote central
 - communication settings, 198, 201
 - Reporting
 - datapoint property description, 51
 - Reset
 - runtime counter, 185
 - Resolution
 - datapoint property description, 52
 - Restart
 - controller, 257
 - plant, 136
 - Restore
 - application files, 17
 - Ringbuffer
 - trend, 218
 - Role
 - datapoint, 177
 - Runtime (active time)
 - datapoint property description, 52
 - Runtime (active time), 185
 - Runtime counter
 - datapoint, 185
 - reset, 185
- S**
- Safety position
 - datapoint property description, 52
 - Safety value
 - datapoint property description, 53
 - Schedule
 - assignable datapoints, 154
 - create, 152
 - create exceptions, 161
 - datapoint filter, 153
 - default value, 158
 - define datapoint filter, 153, 154
 - details, 156, 157
 - enhanced mode, 155
 - enter description, 156, 157
 - enter schedule name, 156, 157
 - priority for writing, 156, 157
 - property selection, 153
 - read/write access level
 - schedule, 156, 157
 - select property to switch, 154
 - select switched properties, 153
 - valid period, 156, 157
 - Schedule default value, 158
 - Null, 158
 - Schedule name
 - enter, 156, 157
 - Schedules, 97
 - general, 151
 - overview, 16
 - view, 151
 - Selected points/parameters
 - fast access list, 138
 - Sensor offset
 - datapoint property description, 54
 - Serial port
 - communication settings, 198, 201
 - select for modem communication, 100, 198
 - Setpoint
 - use for BACnet analog value, 183
 - use for BACnet binary value, 183
 - use for BACnet multi-state value, 183
 - Setpoints and Parameters
 - display, 143
 - Show references
 - of calendar, 173
 - Shutdown
 - plant, 136
 - Source weekday, 160
 - Specific date
 - exception, 163
 - validity type, 163
 - Start alarm time, 87
 - Start/stop time
 - trend, 220
 - Alarm, 225
 - State
 - alarm, 225
 - State text
 - datapoint property description, 55
 - Statistic properties
 - LON statistics, 204
 - Statistics
 - BACnet, 206, 208, 210
 - LON, 204
 - panel bus, 207
 - Status flag
 - fault, 37, 86
 - in alarm, 37, 39
 - out of service, 87
 - overridden, 86
 - Status flag
 - observation (event enrollment), 193
 - Status flags
 - alarm, 226
 - ALM (in alarm, 175
 - datapoint, 86
 - FLT (fault, 175
 - indications, 83
 - OOS (out of service, 175
 - Stop when full
 - trend buffer option, 218
 - Summary

- fast access list, 147
- Suppress
 - alarm, 87
- Switched properties, 98
 - select for schedule, 153, 154
 - weekly program**, 158
- Switchpoint value
 - Null, 159
- Switchpoints, 98
 - copy in weekly program, 160
 - copy mode, 160
 - create for exception, 162
 - delete, 162
 - delete from weekly program, 159
 - priority, 162
- Synchronization
 - user data, 129
- System admin
 - user level, 123
- System date, 100
 - system settings, 198
- System overview
 - features of Eagle controller, 11
- System settings, 100
 - communication, 198, 201
 - cycle time categories, 201
 - cycle time category, 198
 - email, 201
 - modem, 201
 - system date, 198
 - system time, 198
 - time zone, 198
- System status
 - controller information, 131
- System time
 - system settings, 198

T

- Target cycle time
 - cycle times, 200
- Telnet
 - communication protocol, 14
- Template configuration
 - define for fast access list, 145
- Tenant
 - user level, 123
- Test
 - email, 203
- Alarm, 225
- Text
 - alarm, 225, 226
- Time
 - clock, 198
- Time of last reset, 185
 - datapoint property description, 55
- Time of state count reset
 - datapoint property description, 56
- Time programs, 97
- Time programs
 - see Calendars, 16
 - see Schedules, 16
- Time synchronization, 15
- Time to close
 - datapoint property description, 54
- Time to open

- datapoint property description, 54
- Time zone
 - clock, 198
 - set, 100
 - system settings, 198
- Time-based trending
 - see also value-based trending, 214
- Timestamp
 - alarm, 225
- To Fault
 - notification class object type, 95
 - transition events, 85
- To-Normal
 - notification class object type, 95
- To-Offnormal
 - transition events, 85
- To-Offnormal
 - notification class object type, 95
- Transition events
 - Back To-Normal, 85, 95
 - datapoint, 85
 - datapoint property description, 56
 - To Fault, 85
 - To-Offnormal, 85
- Transitions
 - alarm, 226
 - alarm categories relationship, 95
 - datapoint, 178
 - event category relationship, 95
- Tree navigation
 - Eagle HTML interface, 116
- Trend
 - active state of datapoint, 215
 - add points, 214
 - BACnet points, 214
 - buffer settings, 216
 - changes, 216
 - datapoint filter, 214
 - datapoint list, 215
 - datapoint selection, 214
 - delete points, 214
 - details, 216
 - enabled for datapoint, 215
 - log, 221
 - parameter, 216, 219
 - read/write access level, 221
 - ring buffer, 218
 - start/stop time, 220
 - stop when full (buffer), 218
 - trended object, 221
 - trended property, 221
 - trended property of datapoint, 215
 - type (value-based / time-based, 216, 219)
 - view records, 224
- Trend buffer
 - change, 216
- Trend records
 - LON statistics, 204
 - view list, 224
- Trend records file (LON)
 - download, 204
- Trend records filter (LON), 204
- Trend start / stop time
 - change, 216
- Troubleshooting, 258
- Type

datapoint, 177
trend, 219

U

Units of measurement
 project information, 130
Unreliable other
 reliability, 50, 182
Urgent
 notification class, 44
User
 change password, 122
 create, 122, 124
 delete, 129
 delete, 122, 129
 edit, 122, 127
 enter password, 125
 enter user name, 124
 HMI Pin, 125
 select access level, 125, 128
 select decimal places, 127, 129
 select preferred language, 125, 129
User administration, 19
 access level display, 122
 access rights, 20
 decimal places, 20
 decimal places display, 122
 email alarming, 248
 invoke, 122
 language, 20
 language preference display, 122
 overview, 15
 password, 20
 user level, 20
 user name, 20
 user name display, 122
User data
 synchronization, 129
User level
 building engineer, 123
 guest, 123
 operator, 123
 project admin, 123
 select for access right, 123
 system admin, 123
 tenant, 123
 user administration, 20
User name
 communication settings, 100, 198
User name
 user administration, 20
User name
 enter for new user, 124
User name definition
 communication settings, 198, 201
User name display
 user administration, 122

User profile, 20

V

Valid period
 exception, 163
 schedule, 156, 157
Validity type
 calendar reference, 163
 date entry (calendar), 167
 date range, 163
 recurring event, 163
 specific date, 163
Value
 alarm, 226
 parameter, 234
Value datapoints
 general, 23
value-based trending *see also* time-based trending, 214
Values
 datapoint, 176
 datapoint details, 176
Version data
 controller related, 133, 134
View
 alarming of datapoint, 178
 calendars, 165
 command priorities of datapoint, 186
 datapoint details, 175
 datapoint list, 174
 existing schedules, 151
 fast access list, 147
 LON trend records, 205
 values of datapoint, 181
LON trend records, 205
Viewing information
 Eagle HTML interface, 116

W

Watchdog behavior
 controller, 257
Web pages version
 controller, 133, 134
Web server version
 controller, 133, 134
Weekly program
 copy switchpoints, 160
 delete switchpoints, 159
With switches (3 position output
 datapoint property description, 57
Write access level
 datapoint property description, 57

X

XWadmin.Ini, 254

Manufactured for and on behalf of the Environmental and Energy Solutions Division of Honeywell Technologies Sàrl, Rolle, Z.A. La Pièce 16, Switzerland by its Authorized Representative:

Centraline
Honeywell GmbH
Böblinger Strasse 17
71101 Schönaich, Germany
Phone +49 (0) 7031 637 845
Fax +49 (0) 7031 637 740
info@centraline.com
www.centraline.com

Subject to change without notice
EN2Z-097GE51 R0917

